

HAMMERHEAD™

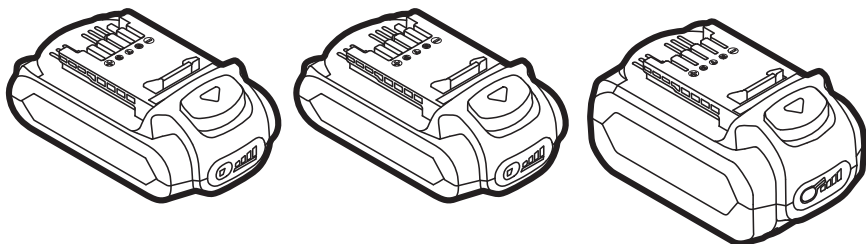

20V 1.5AH/2.0AH/4.0AH BATTERY



MODEL HCBT015/HCBT020/HCBT040

ATTACH YOUR RECEIPT HERE

Serial Number _____ Purchase Date _____



Questions, problems, missing parts? Before returning to your retailer, call our customer service department at 1-877-888-1880, 8:30 a.m. – 8:00 p.m. EST (Monday – Friday) & 10:00 a.m. – 6:00 p.m. EST (Saturday and Sunday).

TABLE OF CONTENTS

Product Specifications	3
Safety Information	4
Preparation	7
Package Contents	8
Operating Instructions	9
Care and Maintenance	12
Battery Care	12
For Recycling	13
Troubleshooting	13
Warranty	14

SAFETY INFORMATION

PRODUCT SPECIFICATIONS

Model No.	HCBT015	HCBT020	HCBT040
Battery Capacity	1.5Ah	2.0Ah	4.0Ah
Battery Voltage	20V DC		
Battery Type	Lithium-Ion		
Charger Compatibility	HCCG013, HCCG040		
Charging Time with HCCG013	225mins	300mins	600mins
Charging Time with HCCG040	60mins	75mins	150mins
Recommended Charging Temperature	41~104°F (5~40°C)		
Recommended Storage Temperature	41~104°F (5~40°C)		
Recommended Working Temperature	41~104°F (5~40°C)		

Please read and understand this entire manual before attempting to assemble or operate this product. If you have any questions regarding the product, please call Hammerhead customer service at 1-877-888-1880, 8:30 a.m. – 8:00 p.m. EST (Monday – Friday) & 10:00 a.m. – 6:00 p.m. EST (Saturday and Sunday).

WARNING

The operation of any power tool can result in foreign objects being thrown into your eyes, which can result in severe eye damage. Before beginning power-tool operation, always wear safety goggles or safety glasses with side shields and a full-face shield, when needed. We recommend using a wide vision safety mask over eyeglasses or standard safety glasses with shields. Always use eye protection marked to comply with ANSI Z87.1.

DANGER





People with electronic devices, such as pacemakers, should consult their physician(s) before using this product. Operation of electrical equipment in close proximity to a heart pacemaker could cause interference or failure of the pacemaker.

SAFETY INFORMATION

Know the Tool

To operate this tool, carefully read this manual and all labels affixed to the battery before using it. Keep this manual available for future reference.

Some of the following symbols may be used on this charger. Please study them and their meaning. Proper interpretation of these symbols will allow you to operate the tool better and more safely.

SYMBOL	DEFINITION	SYMBOL	DEFINITION
V	Volts	A	Amps
Wh	Watts-Hours	Ah	Ampere-Hours
min	Minutes		Direct current
	A danger, warning or caution. It means ‘ ATTENTION! Your safety is involved. ’		Li-ion RBRC seal
	Read the instructions		This symbol designates that this tool is listed by Underwriters Laboratories, to United States and Canadian Standards.

IMPORTANT: This tool should only be serviced only by a qualified service technician.

IMPORANT SAFETY INSTRUCTIONS

SAVE THESE INSTRUCTIONS—This manual contains important safety and operating instructions for batteries MODEL HCBT015/HCBT020/HCBT040.

DANGER

To reduce the risk of fire or electric shock, carefully follow these operating instructions.

SAFETY INSTRUCTIONS

 **WARNING** Read all safety warnings, instructions, illustrations and specifications. Failure to follow all instructions listed below may result in electric shock, fire and/or serious injury.

SAVE ALL WARNINGS AND INSTRUCTIONS FOR FUTURE REFERENCE.

The term “power tool” in the warnings refers to your mains-operated (corded) power tool or battery-operated (cordless) power tool.

SAFETY INFORMATION

Work area safety

- **Keep work area clean and well lit.** Cluttered or dark areas invite accidents.
- **Do not operate power tools in explosive atmospheres, such as in the presence of flammable liquids, gases or dust.** Power tools create sparks which may ignite the dust or fumes.

Electrical safety

- **Do not expose power tools to rain or wet conditions.** Water entering a power tool will increase the risk of electric shock.

Battery tool use and care

- **Recharge only with the charger specified by the manufacturer.** A charger that is suitable for one type of battery pack may create a risk of fire when used with another battery pack.
- **Use power tools only with specifically designated battery packs.** Use of any other battery packs may create a risk of injury and fire.
- **When battery pack is not in use, keep it away from other metal objects, like paper clips, coins, keys, nails, screws or other small metal objects, that can make a connection from one terminal to another.** Shorting the battery terminals together may cause burns or a fire.
- **Under abusive conditions, liquid may be ejected from the battery; avoid contact. If contact accidentally occurs, flush with water. If liquid contacts eyes, additionally seek medical help.** Liquid ejected from the battery may cause irritation or burns.
- **Do not use a battery pack or tool that is damaged or modified.** Damaged or modified batteries may exhibit unpredictable behavior resulting in fire, explosion or risk of injury.
- **Do not expose a battery pack or tool to fire or excessive temperature.** Exposure to fire or temperature above 265 °F may cause explosion.
- **Follow all charging instructions and do not charge the battery pack or tool outside the temperature range specified in the instructions.** Charging improperly or at temperatures outside the specified range may damage the battery and increase the risk of fire.

Service

- **Have your power tool serviced by a qualified repair person using only identical replacement parts.** This will ensure that the safety of the power tool is maintained.
- **Never service damaged battery packs.** Service of battery packs should only be performed by the manufacturer or authorized service providers.

SAFETY INFORMATION

Specific Safety Rules

- **Before using battery, read all instructions and cautionary markings on (1) battery charger, (2) battery pack, and (3) product using battery.**
- **Risk of fire and burns. Do not recharge, disassemble, heat above 100 °C(212 °F), or incinerate. Keep battery out of reach of children and in original package until ready to use.**
- **Battery tools do not have to be plugged into an electrical outlet; therefore, they are always in operating condition. Be aware of possible hazards when not using your battery tool or when changing accessories.**
- **Do not place battery tools or their batteries near fire or heat.**
- **Charge battery pack within the required temperature range.**
- **Store charger and battery pack in locations where temperature is within the recommended storage temperature range.** This is important to prevent serious damage to the battery cells.
- **Do not crush, drop or damage the battery pack. Do not use a battery pack or charger that has been dropped or received a sharp blow.** A damaged battery is subject to explosion. Properly dispose of a dropped or damaged battery immediately.
- **Do not insert battery pack in charger if battery pack case is cracked.** Using damaged battery pack may result in electric shock or fire.
- **Batteries vent hydrogen gas and can explode in the presence of a source of ignition such as a pilot light.** To reduce the risk of serious personal injury, never use any cordless product in the presence of open flame. An exploded battery can propel debris and chemicals. If exposed, flush with water immediately.
- **Do not recharge battery in damp or wet environment. Do not expose charger to rain or snow.** Water entering battery charger may result in electric shock or fire.
- **Do not store outside or in vehicles.**
- **Do not store battery pack in charger.** Battery pack stored in charger over a long period of time could lead to battery pack damage and fire.
- **Battery leakage may occur under extreme usage or temperature conditions. Avoid contact with skin and eyes.** The battery liquid is caustic and could cause chemical burns to tissues. If liquid comes in contact with skin, wash quickly with soap and water. If the liquid contacts your eyes, flush them with water for a minimum of 10 minutes and seek medical attention.
- **Do not let gasoline, oils, petroleum-based products, etc. come in contact with plastic parts.** They contain chemicals that can damage, weaken or destroy plastic.
- **Do not touch the uninsulated portion of output connector or uninsulated battery terminal.** There is a risk of electric shock.

SAFETY INFORMATION

- **Replace battery pack if a substantial drop in operating time per charge is observed.** Battery pack may be nearing the end of its life.

PREPARATION

Before attempting to use the battery, familiarize yourself with all of its operating features and safety requirements.

PACKAGE CONTENTS

1

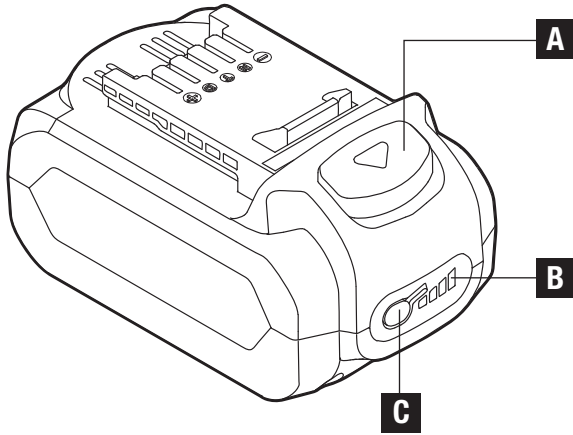

PARTS	DESCRIPTION
A	Battery-release Button
B	Power-indicator
C	Power-indicator Button

OPERATING INSTRUCTIONS

⚠ WARNING To reduce the risk of fire, personal injury, and product damage due to a short circuit, never immerse your charger or battery pack in fluid or allow a fluid to flow inside them. Corrosive or conductive fluids, such as seawater, certain industrial chemicals, and bleach or bleach-containing products, etc, can cause a short circuit.

⚠ WARNING Do not attempt to modify the battery pack or create accessories not recommended for use with this battery pack. Any such alteration or modification is misuse and could result in a hazardous condition leading to possibly serious personal injury.

1. Power Indicator (FIG.2)

This lithium-ion battery pack is equipped with a power indicator that displays the battery pack's charge status. Press the power-indicator button to display the LED lights in the power indicator. The LED lights will stay lit for approximately 5 seconds. It is recommended that the battery pack be brought up to full charge before starting a big job or using it for an extended period of time.





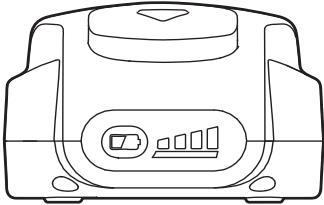

NOTICE: The power indicator can be used whether the battery is attached or removed from tool.

Press the power-indicator button to display the battery pack charge status.

2



Flash Off On

80-100% Charge	
60-79% Charge	
40-59% Charge	
20-39% Charge	
under 20% Charge	
completely discharged	

OPERATING INSTRUCTIONS

2. Low Capacity Warning

If one LED on the power indicator begins to flash, the battery pack's charge is under 20% capacity and should be recharged. Unlike other types of battery packs, lithium-ion battery packs deliver fade-free power for their entire run time. The tool will not experience a slow, gradual loss of power as it is used. The power delivered to the tool will drop quickly when the battery pack is at the end of its run time and needs to be charged. It is not necessary to completely discharge the battery pack before recharging. Remove the battery pack from the tool and recharge it when it is convenient or when it is not in use.

3. Over-temperature Warning

The battery circuitry also protects the battery pack from over heating. To protect the battery pack from damage and prolong its life, the battery pack circuitry will send a warning signal to the tool if the temperature becomes too high during use. All power indicators will stay RED to warn of the over-temperature condition. This may happen in extremely high torque, binding, and stalling situations. The battery pack will begin normal operation after it has cooled down.

NOTICE: A significantly reduced run time after fully charging the battery pack indicates that the batteries are near the end of their usable life and must be replaced.

4. Cold Weather Operation

When the battery pack is very cold, the performance may be weakened. Put the battery pack on a tool and use the tool in a light application for a while to "warm up" the battery pack or place the battery pack under room temperature for conditioning. The battery pack will operate normally.

OPERATING INSTRUCTIONS

5. To Charge The Battery Pack

NOTICE: This lithium-ion battery pack is shipped partially charged. Before using it the first time, fully charge the battery pack.

- a. Always charge the battery pack with the correct charger.
- b. Connect the charger to a power supply.
- c. Attach the battery pack to the charger by aligning the raised ribs of the battery pack with the slot in the charger. Slide the battery pack onto the charger (Fig. 3).
- d. When the charger indicates that the battery pack is fully charged, remove it from the charger.

Please refer to the charger manual for detailed charging operation instructions.

NOTICE: If the battery pack cannot accept a charge, the contacts of the charger or battery pack may be contaminated. Clean the contacts of the charger or battery pack (e.g., by inserting and removing the battery several times or scrubbing with a cotton swab and alcohol), or replace the battery pack, as required.

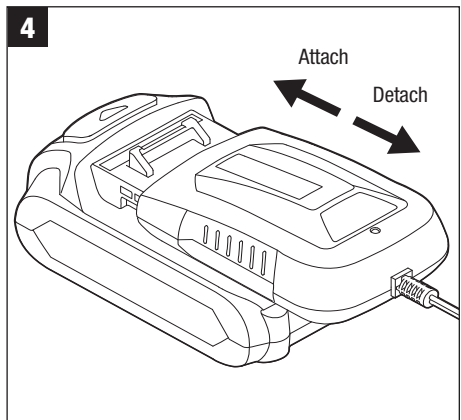
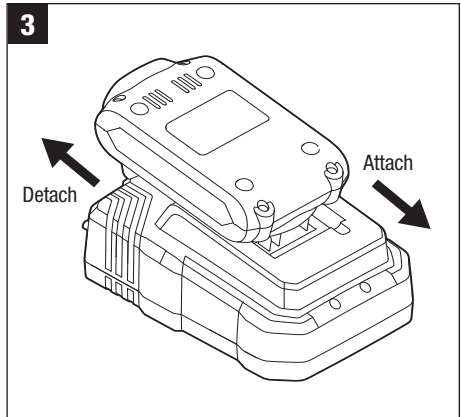

CARE AND MAINTENANCE

Service

 **WARNING: Preventive maintenance performed by unauthorized personnel may result in misplacing of internal wires and components which could cause serious hazard.** Please contact customer service or an authorized service center for assistance.

General Maintenance

 **WARNING: When servicing, use only identical replacement parts. Use of any other parts could create a hazard or cause product damage.**

Periodically inspect the entire product for damaged, missing, or loose parts such as screws, nuts, bolts, caps, etc. Tighten securely all fasteners and caps and do not operate this product until all missing or damaged parts are replaced. Please contact customer service or an authorized service center for assistance.

 **WARNING: To avoid serious personal injury, always remove the battery pack from the charger/tool when cleaning or performing any maintenance.**

Cleaning

 **WARNING:** The tool may be cleaned most effectively with compressed dry air. **Always wear safety goggles when cleaning tools with compressed air.** Do not attempt to clean by inserting pointed objects through openings.

 **WARNING: Certain cleaning agents and solvents damage plastic parts.** Some of these are: gasoline, carbon tetrachloride, chlorinated cleaning solvents, ammonia and household detergents that contain ammonia. Always use only a soft, dry cloth to clean your battery pack; never use detergent or alcohol.

Storage

Store the tool indoors in a place that is inaccessible to children. Keep it away from corrosive agents.

BATTERY CARE

 **WARNING: When batteries are not installed on the tool or charger, keep them away from metal objects.** For example, to protect terminals from shorting DO NOT place batteries in a tool box or pocket with nails, screws, keys, etc. Fire or injury may result.

DO NOT PUT BATTERIES INTO FIRE OR EXPOSE TO HIGH HEAT. They may explode.

FOR RECYCLING



To preserve natural resources, please recycle or dispose of batteries properly. This product contains lithium-ion batteries. Local, state, or federal laws may prohibit disposal of lithium-ion batteries in ordinary trash. Consult your local waste authority for information regarding available recycling and/or disposal options.

TROUBLE SHOOTING

Problem	Cause	Remedy
Battery pack will not charge	Over or under optimal operating temperature.	Cool the battery pack if too hot or place the battery pack in room temperature if too cold.
	Defective charger	Have the charger serviced by Hammerhead customer service.
	Defective battery pack.	Have the battery pack serviced by Hammerhead customer service

WARRANTY

This battery is warranted to the original purchaser from the original purchase date for 12 Months, Hammerhead consumer portable power tool models will be free from defects in material or workmanship for a period of ninety days if the tool is used for professional use. Please retain your receipt.

This battery is warranted to the original user to be free from defects in material and workmanship. If you believe that the battery is defective at any time during the specified warranty period, call HAMMERHEAD support at 1-877-888-1880 to speak with a customer service agent. This warranty does not cover: (1) Part failure due to normal wear or tool abuse; (2) any parts have been altered or modified by anyone other than an authorized HAMMERHEAD personnel.

This warranty excludes bits, bulbs and accessories. This warranty gives you specific legal rights, and you may also have other rights that vary from state.

HAMMERHEAD™

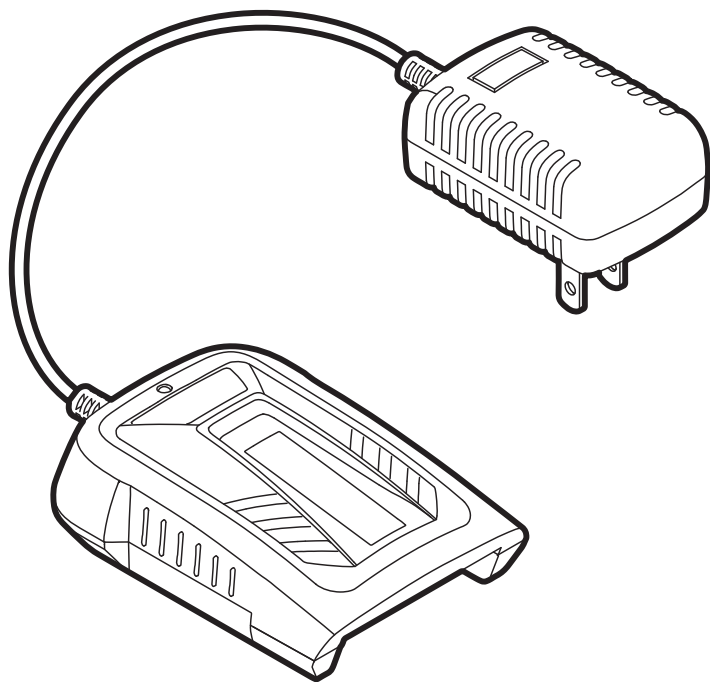

20V CHARGER



MODEL HCCG013

ATTACH YOUR RECEIPT HERE

Serial Number _____ Purchase Date _____



Questions, problems, missing parts? Before returning to your retailer, call our customer service department at 1-877-888-1880, 8:30 a.m. – 8:00 p.m. EST (Monday – Friday) & 10:00 a.m. – 6:00 p.m. EST (Saturday and Sunday).

TABLE OF CONTENTS

Product Specifications	3
Safety Information	4
Preparation.	7
Package Contents.	8
Operating Instructions	9
Care and Maintenance	11
Extension Cords	12
Troubleshooting	13
Warranty.	14

SAFETY INFORMATION

PRODUCT SPECIFICATIONS

COMPONENT	SPECIFICATIONS
Input Voltage	120V~, 60Hz
Input Current	0.25A
Charging Current	0.5A
Charging Time	225mins for 1.5Ah battery HCBT015 300mins for 2.0Ah battery HCBT020 600mins for 4.0Ah battery HCBT040

Please read and understand this entire manual before attempting to assemble or operate this product. If you have any questions regarding the product, please call Hammerhead customer service at 1-877-888-1880, 8:30 a.m. – 8:00 p.m. EST (Monday – Friday) & 10:00 a.m. – 6:00 p.m. EST (Saturday and Sunday).

WARNING

The operation of any power tool can result in foreign objects being thrown into your eyes, which can result in severe eye damage. Before beginning power-tool operation, always wear safety goggles or safety glasses with side shields and a full-face shield, when needed. We recommend using a wide vision safety mask over eyeglasses or standard safety glasses with shields. Always use eye protection marked to comply with ANSI Z87.1.

DANGER







People with electronic devices, such as pacemakers, should consult their physician(s) before using this product. Operation of electrical equipment in close proximity to a heart pacemaker could cause interference or failure of the pacemaker.

SAFETY INFORMATION

Know the Tool

To operate this tool, carefully read this manual and all labels affixed to the charger before using it. Keep this manual available for future reference.

Some of the following symbols may be used on this charger. Please study them and their meaning. Proper interpretation of these symbols will allow you to operate the tool better and more safely.

SYMBOL	DEFINITION	SYMBOL	DEFINITION
V	Volts	Hz	Hertz
Wh	Watts-Hours	A	Amperes
	Alternating Current		Direct current
	A danger, warning or caution. It means ' ATTENTION! Your safety is involved. '		This symbol designates that this tool is listed by the California Energy Commission.
	Read the instructions		This symbol designates that this tool is listed by Underwriters Laboratories, to United States and Canadian Standards.

IMPORTANT: This tool should only be serviced by a qualified service technician.

IMPORANT SAFETY INSTRUCTIONS

SAVE THESE INSTRUCTIONS-This manual contains important safety and operating instructions for charger Model HCCG013

SAFETY INFORMATION

IMPORTANT SAFETY INSTRUCTIONS

 **DANGER** To reduce the risk of fire or electric shock, carefully follow these operating instructions.

- **This manual contains instructions for battery charger model HCCG013.** Do not substitute any other charger.
- **Before using battery charger, read all instructions and cautionary markings on battery charger, battery pack, and product using battery.**
- **Charge only rechargeable batteries listed in the manual** (HCBT015/HCBT020/HCBT040). Other types of batteries may burst causing personal injury and damage.
- **Charge battery pack within the required temperature range. Store charger and battery pack in locations where temperature is within the recommended storage temperature range.** This is important to prevent serious damage to the battery cells.
- **Do not recharge battery in damp or wet environment. Do not expose charger to rain or snow.** Water entering battery charger may result in electric shock or fire.
- **Place charger on flat nonflammable surfaces and away from flammable materials when recharging battery pack.** Carpeting and other heat insulating surfaces block proper air circulation which may cause overheating of the charger and battery pack. If smoke or melting of the charger or battery pack is observed, unplug the charger immediately and do not use the battery pack or charger. Contact customer service immediately.
- **Keep the cord and charger from heat to prevent damage to housing or internal parts.**
- **Do not allow gasoline, oils, petroleum-based products, etc. to come in contact with plastic parts.** These materials contain chemicals that can damage, weaken, or destroy plastic.
- **Make sure cord is located so that it will not be stepped on, tripped over, or otherwise subjected to damage or stress.** Damaged plug and cord may result in electric shock or fire.
- **Disconnect the charger by pulling the plug rather than the cord. Do not operate charger with damaged cord or plug; have them replaced immediately.** Damaged plug or cord may result in electric shock or fire.
- **Do not insert battery pack in charger if battery pack case is cracked.** Using damaged battery pack may result in electric shock or fire.
- **Do not disassemble charger or operate the charger if it has received a sharp blow,**

been dropped or otherwise damaged in anyway. Incorrect reassembly or damage may result in electric shock or fire.

- **Before each use, check the battery charger, cable and plug. If damage is detected, do not use the battery charger. Never open the battery charger yourself, take it to a Factory Service Center, or qualified serviceman only using original spare parts.**
- Incorrect reassembly may result in electric shock or fire.
- **Do not touch the uninsulated portion of output connector or uninsulated battery terminal.** There is a risk of electric shock.
- **Do not store battery pack in charger.** Battery pack stored in charger over a long period of time could lead to battery pack damage and fire.
- **Unplug charger from outlet before storage, attempting any maintenance or cleaning.**
- Such preventive safety measures reduce the risk of electric shock or fire.
- **Keep the battery charger clean by blowing compressed air on charger vents and wiping the charger housing with a damp cloth.** Contamination may result in electric shock or fire.
- **Replace battery pack if a substantial drop in operating time per charge is observed.** Battery pack may be nearing the end of its life.
- **To reduce the risk of injury, close supervision is necessary when an appliance is used near children.**
- **Do not use outdoors.**

FCC CAUTION

1. This device complies with Part 15 of the FCC Rules. Operation is subject to the following two conditions:
 - (1) This device may not cause harmful interference.
 - (2) This device must accept any interference received, including interference that may cause undesired operation.
2. Changes or modifications not expressly approved by the party responsible for compliance could void the user's authority to operate the equipment.

NOTE: This equipment has been tested and found to comply with the limits for a Class B digital device, pursuant to Part 15 of the FCC Rules. These limits are designed to provide reasonable protection against harmful interference in a residential installation. This equipment generates, uses, and can radiate radio frequency energy and, if not installed and used in accordance with the instructions, may cause harmful interference to radio communications.

However, there is no guarantee that interference will not occur in a particular installation. If this equipment does cause harmful interference to radio or television reception, which can be determined by turning the equipment off and on, the user is encouraged to try to correct the interference by one or more of the following measures:

- Reorient or relocate the receiving antenna.
- Increase the separation between the equipment and receiver.
- Connect the equipment into an outlet on a circuit different from that to which the receiver is connected.
- Consult the dealer or an experienced radio/TV technician for help.

⚠ WARNING People with electronic devices, such as pacemakers, should consult their physician(s) before using this product. Operation of electrical equipment in close proximity to a heart pacemaker could cause interference or failure of the pacemaker.

PREPARATION

Before attempting to use the battery, familiarize yourself with all of its operating features and safety requirements.

PACKAGE CONTENTS

1

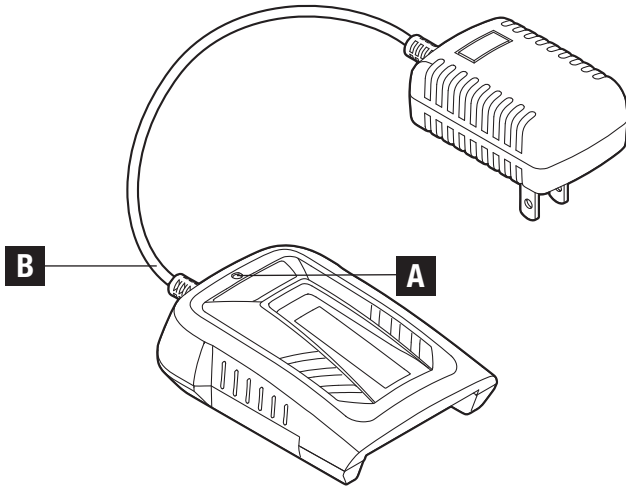

PARTS	DESCRIPTION
A	Charging Indicator
B	Cord

OPERATING INSTRUCTIONS

1. Charge the battery

⚠ WARNING To reduce the risk of fire, personal injury, and product damage due to a short circuit, never immerse your charger or battery pack in fluid or allow a fluid to flow inside them. Corrosive or conductive fluids, such as seawater, certain industrial chemicals, and bleach or bleach-containing products, etc, can cause a short circuit.

NOTICE: The battery pack is shipped partially charged. Before using it the first time, fully charge the battery pack.

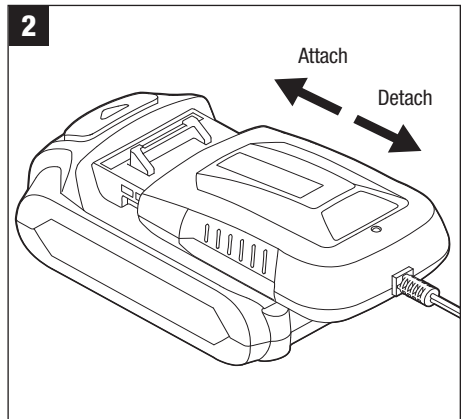

- Charge the battery pack with the correct charger.
- Connect the charger to a power supply. The green charging Indicator will shine for 0.5 second first, then the red indicator will shine for 0.5 second, and then go out, indicating that the charger self-inspection is completed.
- Align the raised ribs of the battery pack with the slot in the charger.
- Insert the charger into the battery pack.
- The charger will communicate with the battery pack to evaluate the condition of the battery pack.
- If the battery pack temperature is within the charging temperature range, the charger will automatically start charging the battery pack. The green charging indicator will flash every second during charging. After the charging is complete, the green charging indicator will remain green, without flashing.
- A flashing red defect indicator indicates a defective battery, a defective charger, or a bad connection between the battery and the charger.
- A solid red defect indicator indicates that the battery is warmer or colder than the optimal temperature. Remove the battery pack from the charger. If the battery is too hot, cool the battery under air flow. If the battery is too cold, place it indoors until it reaches room temperature.
- It is not recommended that the battery pack remain on the charger for more than 24 hours.

NOTICE: If the battery pack cannot accept a charge, the contacts of the charger or battery pack may be contaminated. Clean the contacts of the charger or battery pack (e. g., by inserting and removing the battery several times or cleaning with a cotton swab and alcohol) or replace the charger or replace the battery pack, as required

OPERATING INSTRUCTIONS

2. Charger Display

Mode	Charging Indicator (green)	Defect Indicator (red)	Note
Self-inspection completed	0.5 second	0.5 second	The green light will shine for 0.5 second first, then the red light will shine for 0.5 second.
Normal charging	Flashing	OFF	The charger will automatically start charging the battery pack, if the battery pack temperature is within the charging temperature range.
Fully Charged	Steady green	OFF	
Hot/Cold Battery	OFF	Steady Red	Remove the battery from the charger.
Defective	OFF	Flashing or Off	Charging defect

NOTICE: Charger may become warm with several continuous charge cycles. This is part of the normal operation of the charge. Charge in a well ventilated area.

Defective Charger

If the charger self-inspection fails to react when the charger is plugged in, the causes include no power to the charger, bad contacts, or a defective charger. Check to see if the charger self-inspection can be activated when the charger is plugged in again or plugged into a different outlet. If it still fails, have the charger serviced by an Authorized Service Station.

Defective Battery Pack

If the charger detects a problem, the red Defect Indicator will begin flashing. Remove and re-insert the battery pack in the charger. If the Defect Indicator flashes a second time, try charging a different battery pack.

- a) If a different battery pack charges normally, have the first defective battery pack serviced by an Authorized Service Station.
- b) If a different battery pack also indicates “defective,” the charger may be defective. Have the charger serviced by an Authorized Service Station.

CARE AND MAINTENANCE

Service

 **WARNING:** Preventive maintenance performed by unauthorized personnel may result in misplacing of internal wires and components which could cause serious hazard. Please contact customer service or an authorized service center for assistance.

General Maintenance

 **WARNING:** When servicing, use only identical replacement parts. Use of any other parts could create a hazard or cause product damage.

Periodically inspect the entire product for damaged, missing, or loose parts such as screws, nuts, bolts, caps, etc. Tighten securely all fasteners and caps and do not operate this product until all missing or damaged parts are replaced. Please contact customer service or an authorized service center for assistance.

 **WARNING:** To avoid serious personal injury, always remove the battery pack from the charger/tool when cleaning or performing any maintenance.

Cleaning

 **WARNING:** The tool may be cleaned most effectively with compressed dry air. **Always wear safety goggles when cleaning tools with compressed air.** Do not attempt to clean by inserting pointed objects through openings.

 **WARNING:** Certain cleaning agents and solvents damage plastic parts. Some of these are: gasoline, carbon tetrachloride, chlorinated cleaning solvents, ammonia and household detergents that contain ammonia. Always use only a soft, dry cloth to clean your battery pack; never use detergent or alcohol.

Storage

Store the tool indoors in a place that is inaccessible to children. Keep it away from corrosive agents.

EXTENSION CORDS

⚠ WARNING: If an extension cord is necessary, a cord with adequate size conductors that is capable of carrying the current necessary for your tool must be used. This will prevent excessive voltage drop, loss of power or overheating. Grounded tools must use 3-wire extension cords that have 3-prong plugs and receptacles.

NOTICE: The smaller the gauge number, the heavier the cord.

RECOMMENDED SIZES OF EXTENSION CORDS 120 VOLT ALTERNATING CURRENT TOOLS

Tool's Ampere Rating	Cord Size in A.W.G				Wire sizes in mm ²			
	Cord length in feet				Cord length in meters			
	25	50	100	150	15	30	60	120
3-6	18	16	16	14	0.75	0.75	1.5	2.5
6-8	18	16	14	12	0.75	1.0	2.5	4.0
8-10	18	16	14	12	0.75	1.0	2.5	4.0
10-12	16	16	14	12	1.0	2.5	4.0	-
12-16	14	12	-	-	-	-	-	-

TROUBLE SHOOTING



Suspected malfunctions are often due to causes that the users can fix themselves. Therefore, check the product using this section. In most cases the problem can be solved quickly.



WARNING: Only perform the steps described within these instructions! All further inspection, maintenance and repair work must be performed by an authorised service centre or a similarly qualified specialist if you cannot solve the problem yourself!

PROBLEM	POSSIBLE CAUSE	SOLUTION
Product does not start.	Not connected to power supply.	Connect to power supply.
	Power cord or plug is defective.	Have the tool serviced by an Authorized Service Center.
	Other electrical defect to the product.	Have the tool serviced by an Authorized Service Center.
Battery pack will not charge.	Battery pack is not properly inserted into the charger.	Confirm that the battery pack is inserted into the charger completely.
	Bad contacts	Clean the contacts of the charger or battery packs.
	Battery is over- or undertemperature.	Cool the battery if too hot. Place the battery indoors if too cold.
	Battery pack is damaged	Have the battery pack serviced by an Authorized Service Station
	Charger is damaged	Have the charger serviced by an Authorized Service Station.

WARRANTY

This Charger is warranted to the original purchaser from the original purchase date for 12 Months, Hammerhead consumer portable power tool models will be free from defects in material or workmanship for a period of ninety days if the tool is used for professional use. Please retain your receipt.

This Charger is warranted to the original user to be free from defects in material and workmanship. If you believe that the Charger is defective at any time during the specified warranty period, call HAMMERHEAD support at 1-877-888-1880 to speak with a customer service agent. This warranty does not cover: (1) Part failure due to normal wear or tool abuse; (2) any parts have been altered or modified by anyone other than an authorized HAMMERHEAD personnel.

This warranty excludes bits, bulbs and accessories. This warranty gives you specific legal rights, and you may also have other rights that vary from state.

