



TABLE OF CONTENTS

→ 01 Who Are We?	05
About Grad®	06
Our Services and Commitments	07
→ 02 Decking System	08
Presentation	10
Rails	16
Flat Rail	17
Top Rail	18
PR24	19
PR39	20
PR56	21
Accessories	22
Decking System for Ceramic Tile	28
→ 03 Decking Boards	32
Kebony®	34
Moso®	36
Thermory® Thermo-Pine	38
Thermory® Thermo-Ash	40
Accoya®	42
Nekko	44
UPM	46
Dex	48
→ 04 Cladding System	50
Presentation	52
Rails and Accessories	54
Cladding Boards	55
→ 05 Featured Projects	56





→ 01

WHO ARE WE?

Who are we?
 About Grad®
 Our services

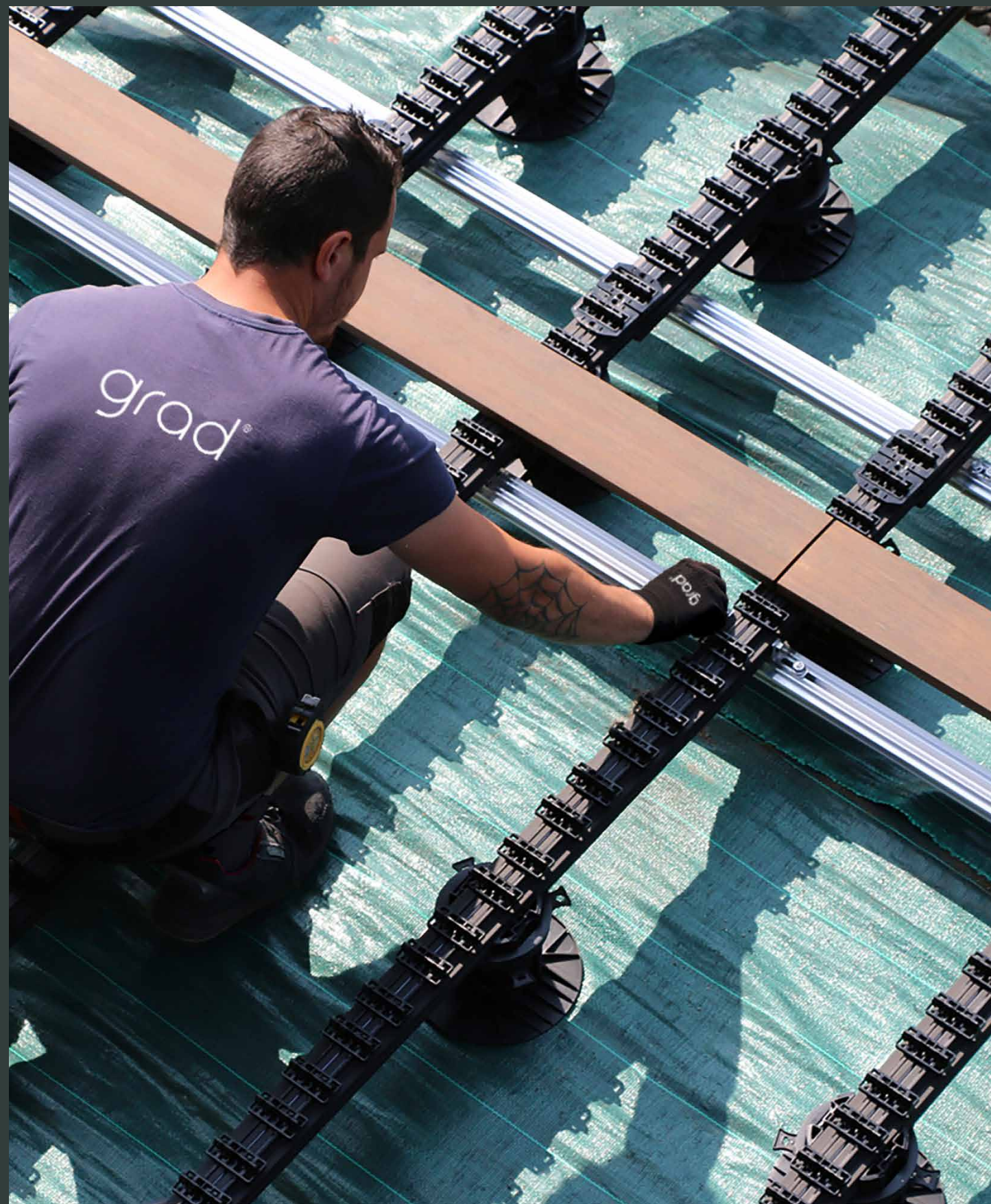

WHO ARE WE?

For almost 20 years, the Grad® team has been perfecting the invisible fastening system with the Grad® Clip.

Through the spirit of innovation, the vision of a sustainable product and the experience gained from our customers, Grad® continues to develop its intelligent, versatile and easy-to-use system.

Thanks to the inventiveness, aestheticism and durability of the product, over the years Grad® has established itself as a product of excellence, of interest to end users, landscapers and architects alike.

It is thanks to its solid foundations and dedicated teams that Grad is exporting all over the world to seduce and convince new users.

OUR COMMITMENTS

Environment.

Grad® shows its commitment to the future through several actions:

- In the design of our products, we choose to work with recycled and recyclable materials. The aluminium used for the rails is >80% recycled aluminium and is 100% recyclable. The plastic used for the injection of accessories and clips is 100% recyclable.
- Our factory is heated with wood chip waste from our production.
- Production made to order.
- Long product life expectancy (20 years) to avoid replacements.
- We favour short supply chains for the procurement of our raw materials.

OUR SERVICES

Warranties.

All products manufactured by Grad® (rails and accessories) are guaranteed for 20 years.

Commercial management.

At Grad®, we take special care of our partners. That is why each partner customer benefits from a dedicated sales representative as well as a key contact at the head office to ensure a constant service rate and availability. We are convinced that commercial relations must be based on dedicated and available customer service representatives.

Grad3D.

We provide our partners with the drawing software Grad3D to allow you to draw and prepare your commercial offers.

In addition, two collaborators at the head office are specialized to train and accompany you in the handling of the tool and in its use.

Design office.

Grad® has a team of product technicians at your disposal to accompany you in your project studies.

Through our internal tool, Grad3D, for residential projects of decking and cladding, or tools like AutoCAD and REVIT for larger scale projects.

We are able to develop all of your custom and most daring projects.

Training.

To allow our partners to fully develop their potential, we set up the Grad® Academy, a multi-stage training course to fully understand the Grad® system, its products, its advantages and its technicalities.

Whether you have a question about the system, sales techniques, installation, or a need for the design software, we will accompany you in your global understanding of Grad®.

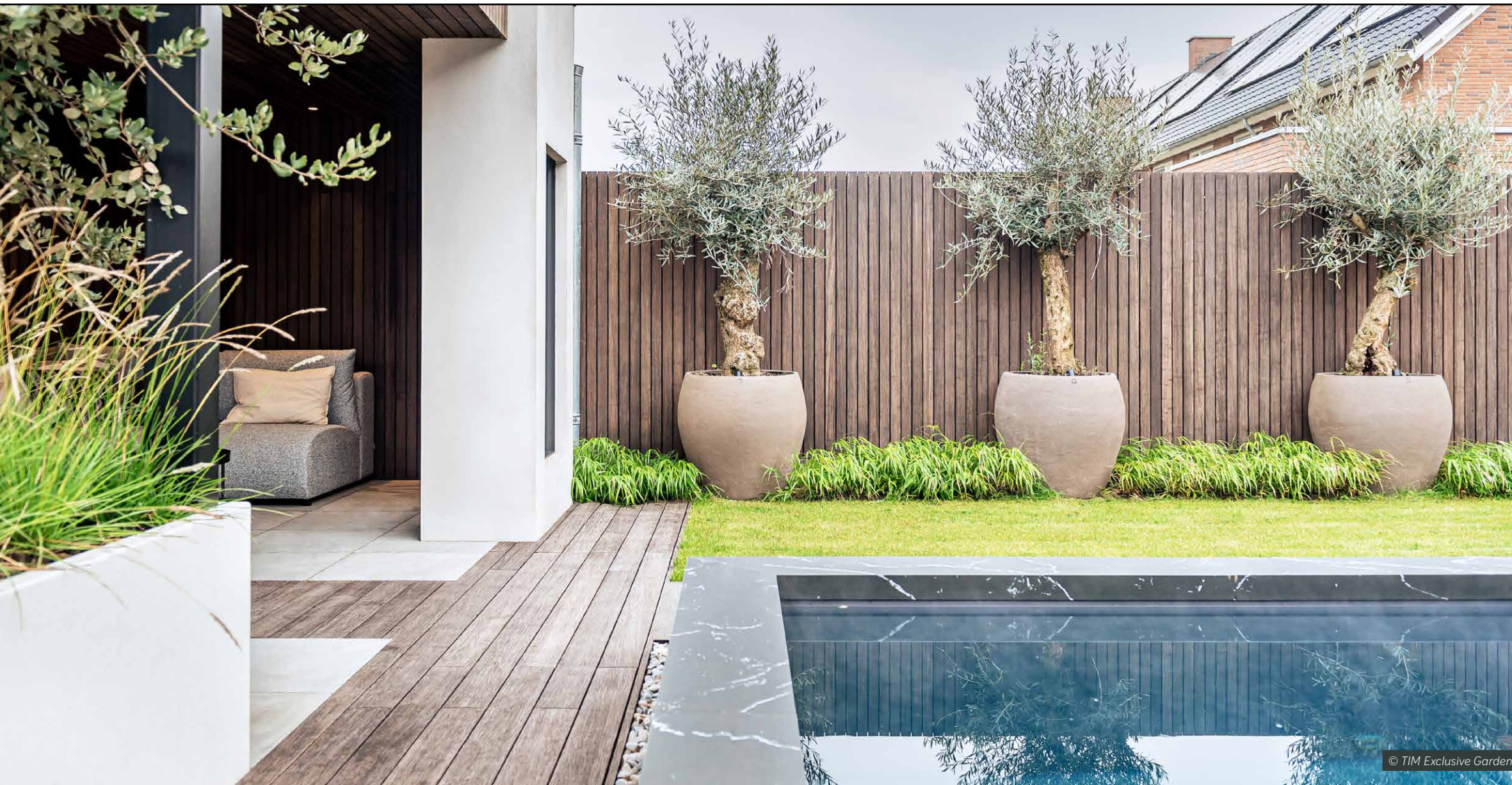

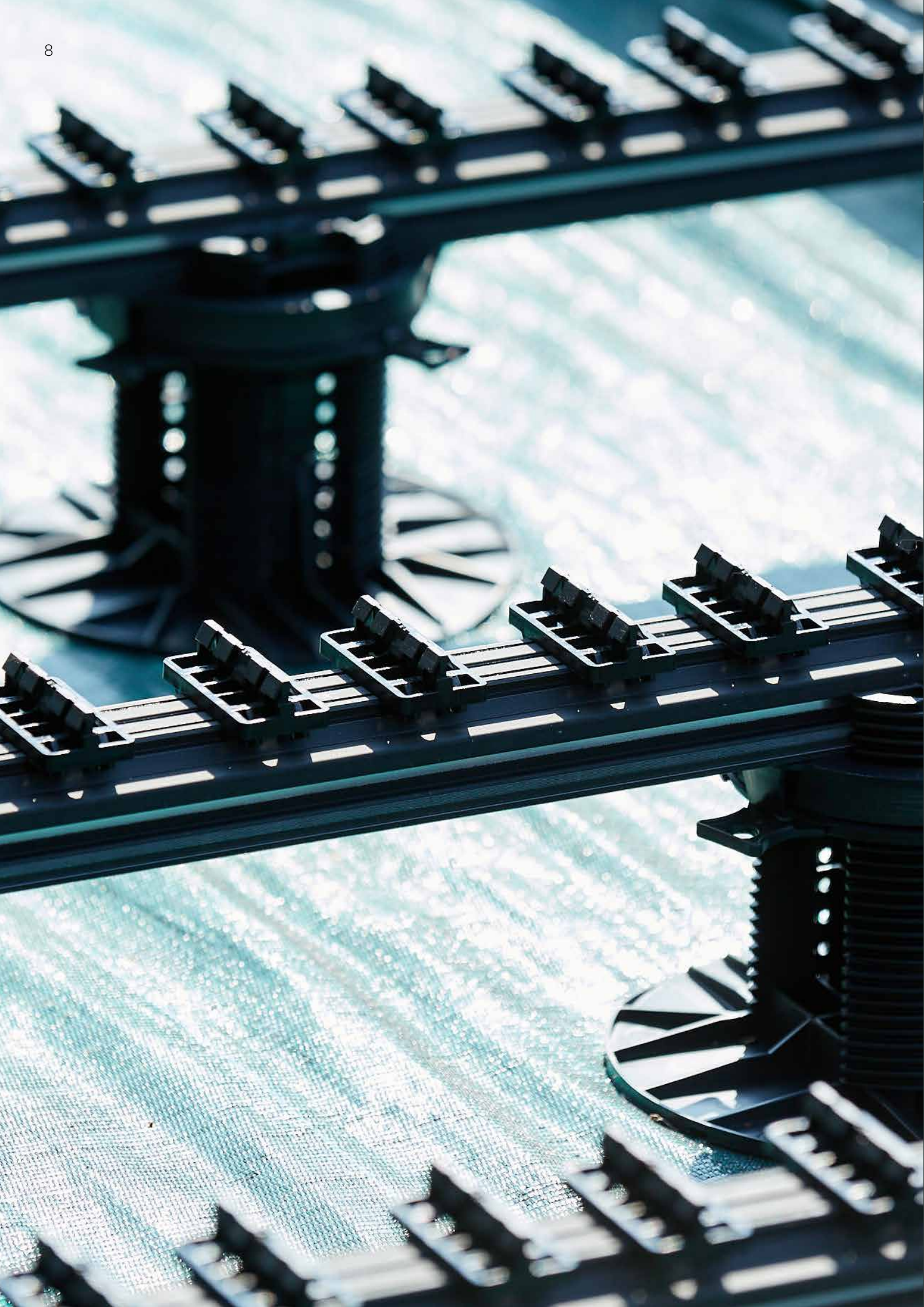

DECKING SYSTEM

Presentation
System for Decking
Rails
Accessories

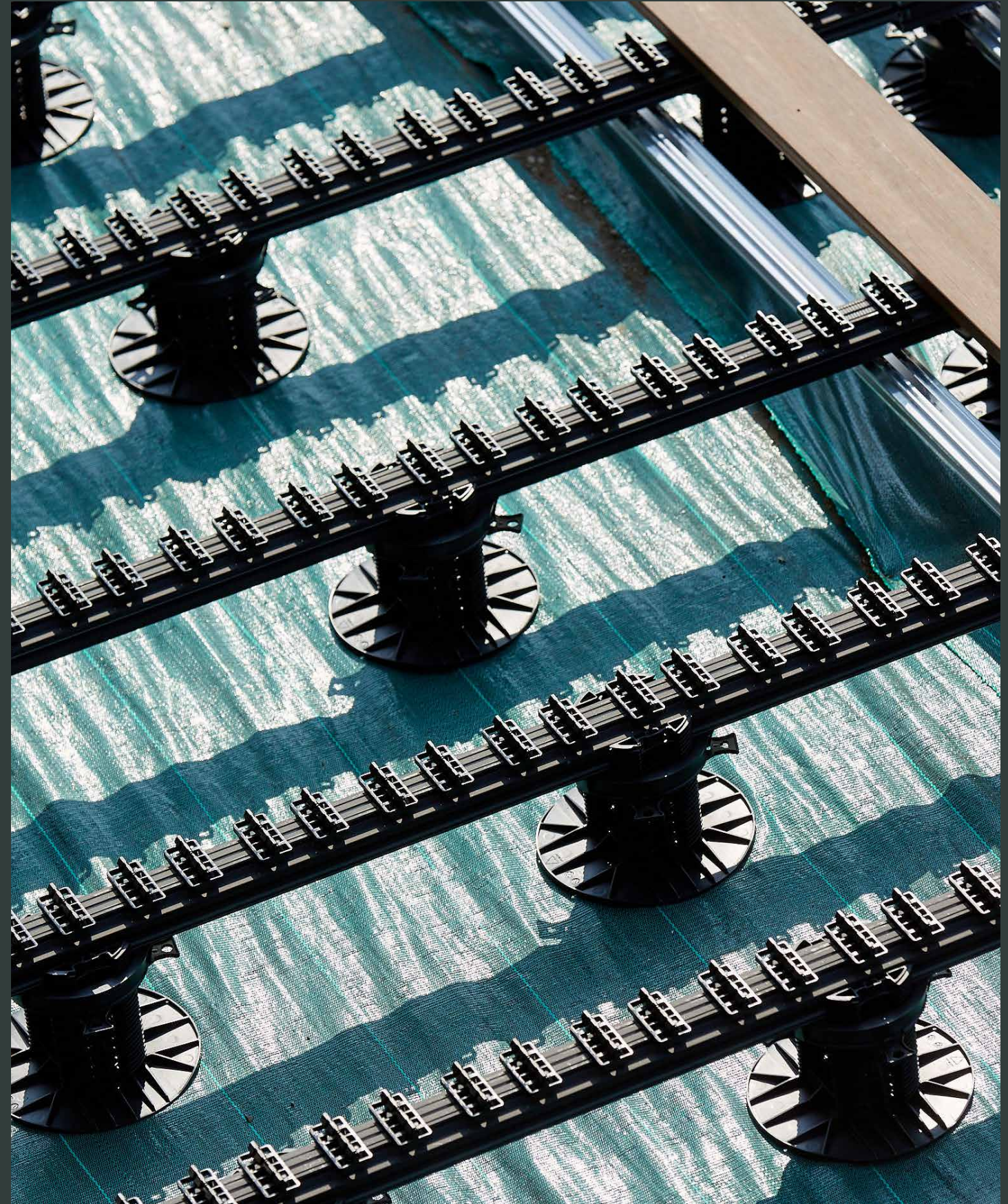



THE HEART OF OUR SYSTEM

ALUMINIUM

The 6060 alloy used for Grad® rails has excellent mechanical properties for structural use, **allowing the systems to be installed for decking and in facades, even in very exposed environments.** This alloy also has a very good resistance to corrosion in outdoor environments near the seaside and in swimming pool areas.

INTERNAL RECYCLING OF SCRAP METAL

Thanks to its high recycling capacity, aluminium is a true energy asset and is integrated into the heart of the circular economy. Recycling is essential, so we apply the necessary sorting instructions **to give new life to aluminium scrap.**



RECYCLED & RECYCLABLE

Because it can be recycled over and over again, using recycled aluminium saves 95% of the energy and 70% of the water needed to produce primary aluminium. Since aluminium does not lose any of its qualities during the recycling process, **this material makes it possible to approach our goal of zero waste in the long term.**

ENVIRONMENT

We manufacture products whose recycling and reuse of materials **minimizes our environmental footprint and preserves natural resources.**

EUROPEAN PRODUCTION

THE GRAD® CLIP

Injected in-house from **POLYOXYMETHYLENE (POM)**



INVISIBLE FASTENING SYSTEM

The Grad® system is recognized as conforming to the requirements of DTU 41-2 (cladding) as well as to the requirements of DTU 51-4 (decking).



FULLY REMOVABLE

It is as easy to unclip a board as to clip it, thanks to keys developed to pass between two boards, and to insert between the aluminium rail and the lugs of the clips. The boards, clips and frame are not damaged, and everything is re-positionable without difficulty.

100% RECYCLABLE

100% FRENCH PRODUCTION

All of our POM products are made in Alsace (Eastern France)

RESISTANT

The Grad® system has been tested in labs (the Grad® lab and conformity labs) and, thanks to its high tensile strength, it can be used on buildings of 10 m and 28 m, even in areas that are highly exposed to wind.

RESOURCE EFFICIENCY

We have updated our injection molding machines by replacing the energy-intensive hydraulic presses with low-consumption electric presses. In addition, air heaters have been installed in the injection molding shop to heat the production area with the heat recovered from the cooling circuit of the injection molding machines.



ABOUT THE GRAD® SYSTEM

SPOTLIGHT ON OUR SYSTEM

Perfect alignment. Optimal stability.

Each installation has its own type of rail and its functionalities and accessories make it possible to ensure all possible configurations, both in terms of decking and finishing. Perfect drip lines, thanks to Grad® clip, installed on automated production lines: a unique concept of pre-equipped rails!

Structural guarantee.

Thanks to our system, the deck is more durable. Boards are not in direct contact with the framework, as the spacing between the boards and the rails is guaranteed by Grad® clips, so no water stagnation is possible.

Perfect finish, every time.

With our invisible fastening system, there are no visible screws to hold the boards in place, therefore maintaining the integrity of the wood and reducing likelihood of splintering/rot that is common with nails.

100% invisible fastening, a unique and patented system.

- + 100% invisible hardware
- + Installation on all types of ground
- + Optimal stability
- + Perfect finish
- + Perfect drainage lines

- + Conforms to all standards
- + 20-year warranty on the structure
- + Can be fully disassembled
- + Mix of wood boards and ceramic tiles possible
- + 100% Made in France

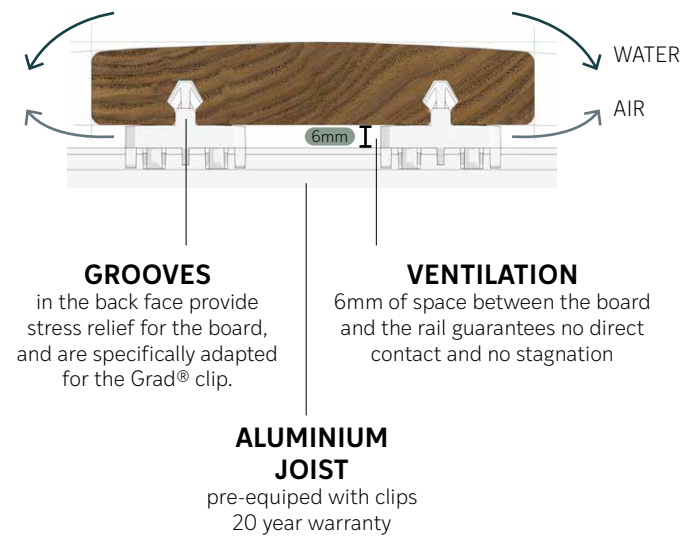

Slotted for the Grad® System.

Since 2004, our R&D team has been developing and improving the slotting system to fit perfectly with the Grad® clip. This way, all boards slotted with our template become compatible with our invisible fastening system.

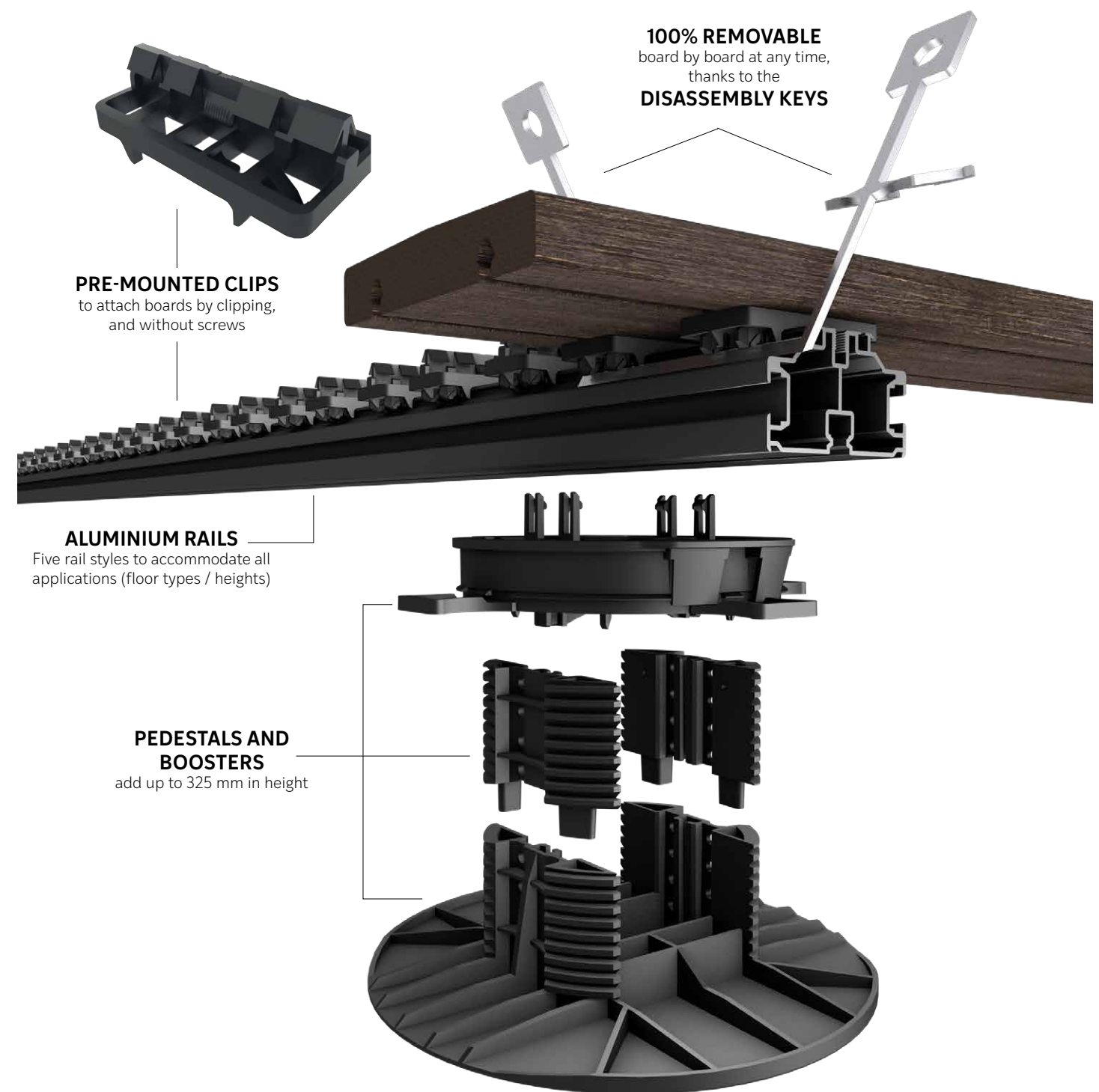

Comfort Profile.

The curved effect of the board is slight, 3.2° for 12 cm wide, i.e. 5.6% slope. An ideal compromise between efficiency and comfort.

The moisture differential between the top and bottom of the deck board creates tension in the wood that eventually causes the deck board to curl.

The comfort profile allows for better water drainage, avoids water traps, and greatly slows down, or even eliminates, the effect of warping.

The wood industry is at the heart of our business and our concerns. The origin of the wood and its treatment are essential criteria when selecting our sources of supply. This is why our entire supply and production chains are based on responsible forest management systems. Our wood decking boards come from well-managed forests. Their origins and the traceability system are tested and approved by third party organizations. This is an environmental commitment that we promote to preserve natural forest resources.



HARD GROUND

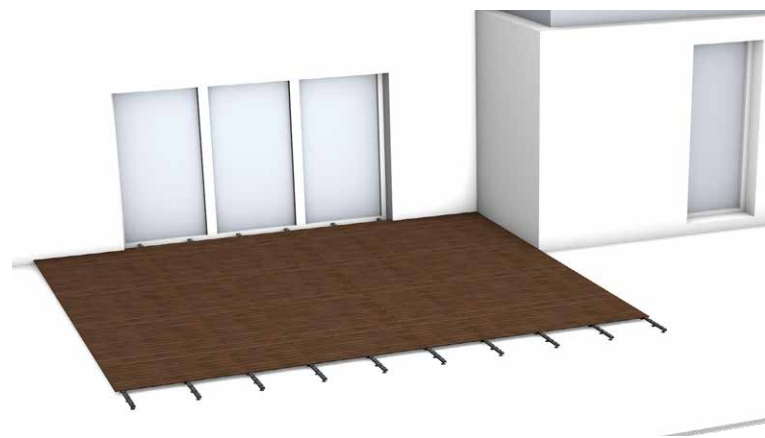

HARD GROUND: Designed for tiling or rough concrete, the structure is isolated from the ground by wedges of different heights, allowing rainwater to drain properly. This configuration reduces the total height of the wooden deck to 4 cm.

STABILIZED GROUND

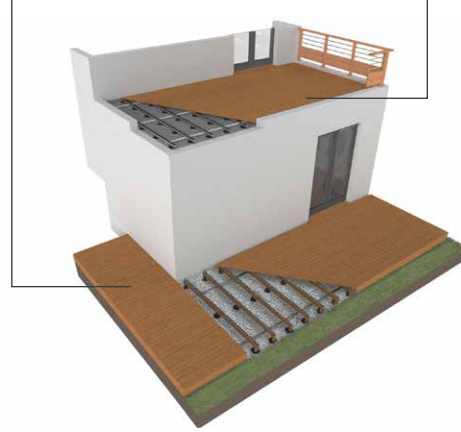

STABILIZED GROUND: The weight of a wood deck rarely exceeds 30 kg/m². In addition, the structure is flexible and interlocking. Thus, as long as the ground is reasonably stable, it is possible to distribute the entire weight of the construction on multiple supports made up of Top Lift® pedestals, without risk of sinking.

WATERPROOF ROOFTOP

WATERPROOF ROOFTOP: To preserve the waterproofing membrane, the Grad® decking rails rest on Top Lift® adjustable pedestals, specially designed for this purpose. Distributed according to very precise calculations, these studs support planters or other heavy products with ease, and without risk of puncturing the membrane. For technical access, all of the boards can be removed with the help of the dismantling keys.

UNSTABLE GROUND

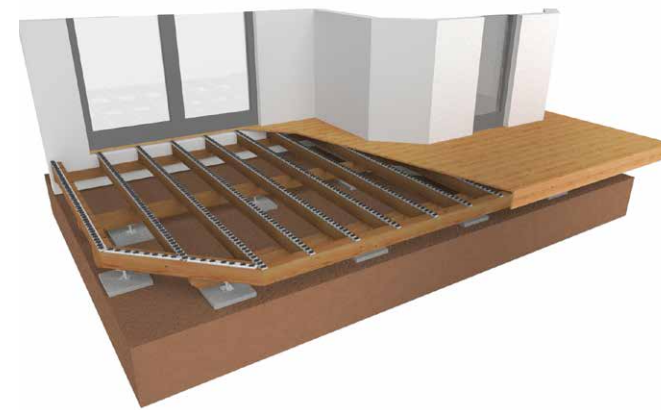

UNSTABLE GROUND: This structure is designed to be installed on ground considered as unstable (freshly backfilled areas or subject to soil movement). The wooden structure rests on fixed foundation elements (concrete, foundation screws) to provide a permanent support.

SELF-SUPPORTING WOOD OR METAL STRUCTURE



SELF-SUPPORTING WOOD OR METAL STRUCTURE: This decking structure rests on a wooden frame raised by posts and allows the installation of rails and wooden decking for heights from 620 mm up to 4m). The unit can be totally self-supporting or linked to the facade depending on the site configuration.

HARD GROUND

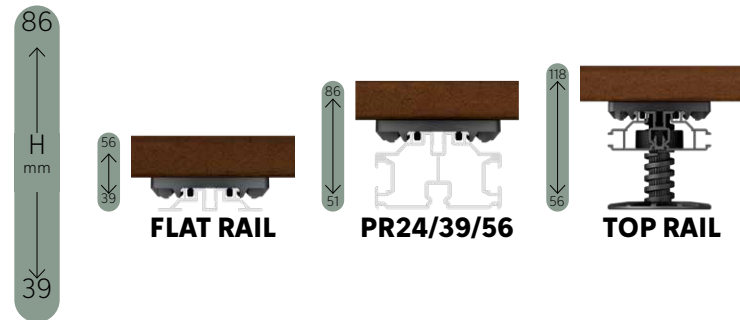

ON PEDESTALS

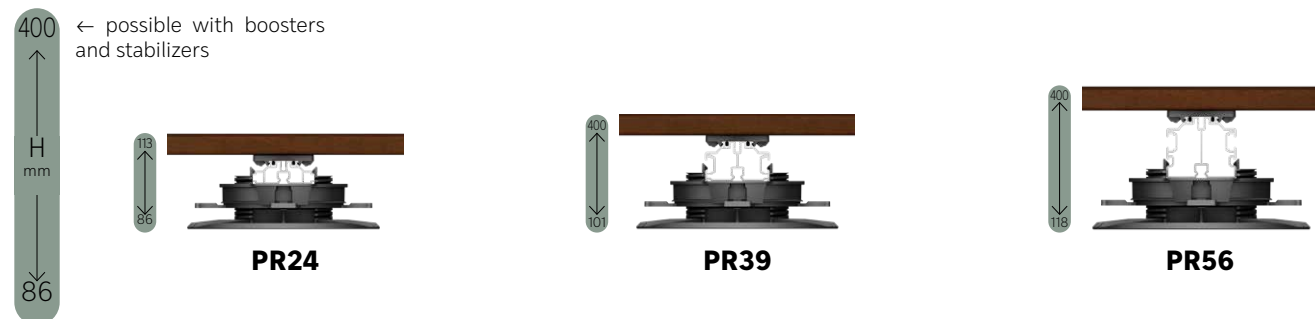

ON WOODEN BEAMS

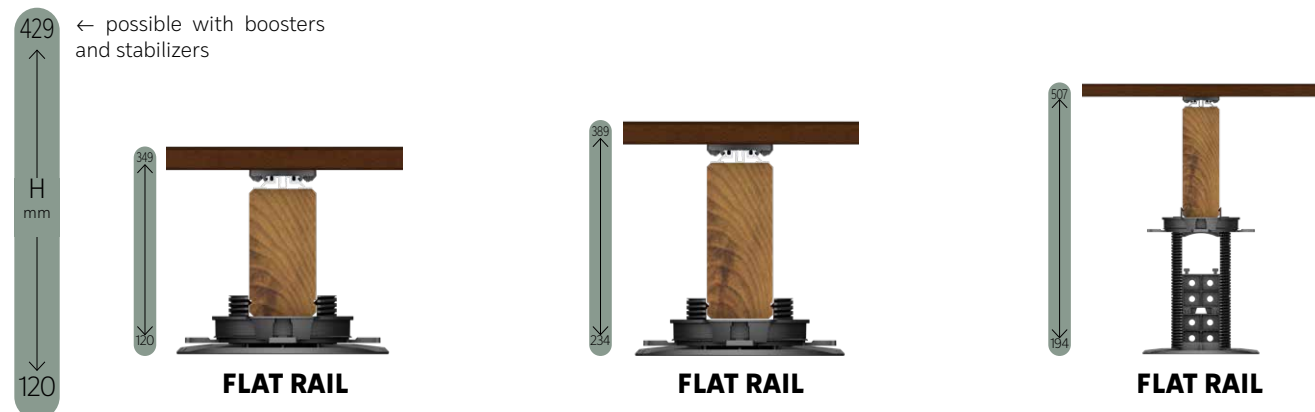

ON FOUNDATIONS

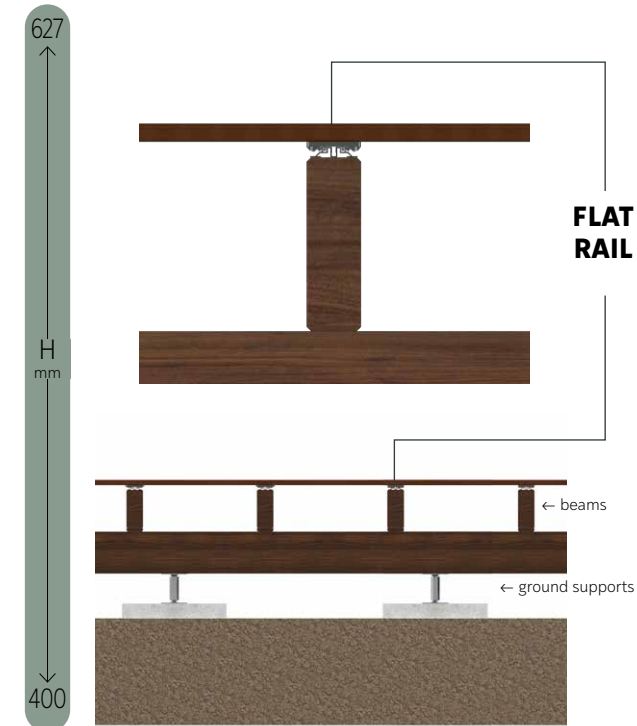

ON POSTS

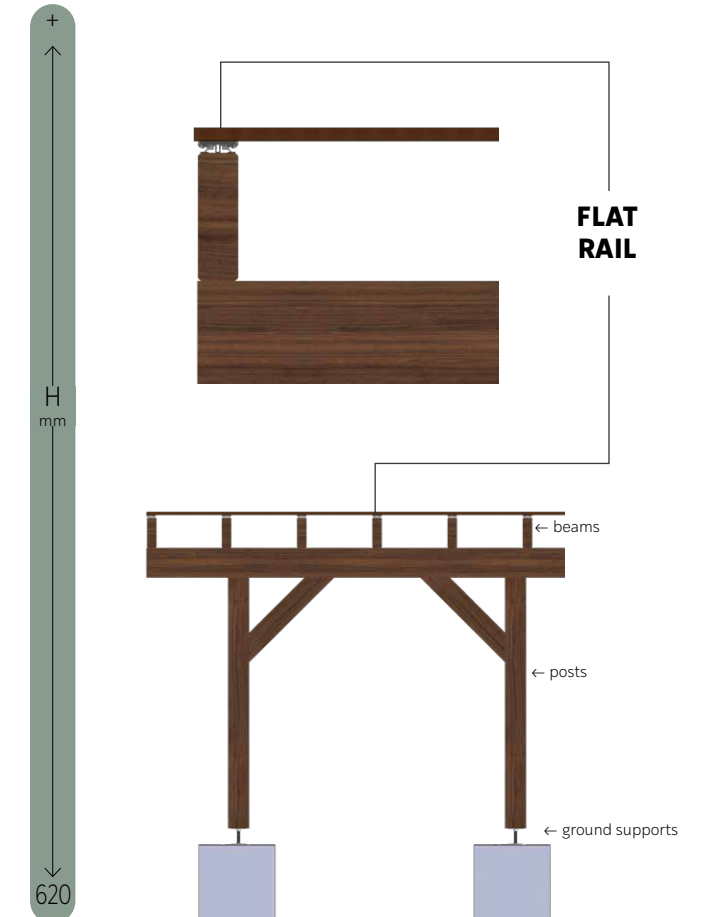

OUR RAILS

References
Technical characteristics
Important information

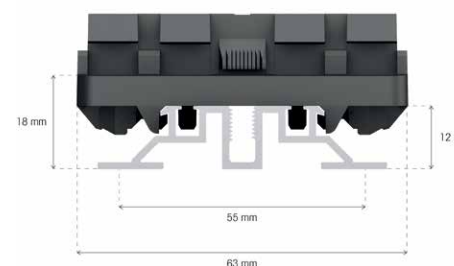
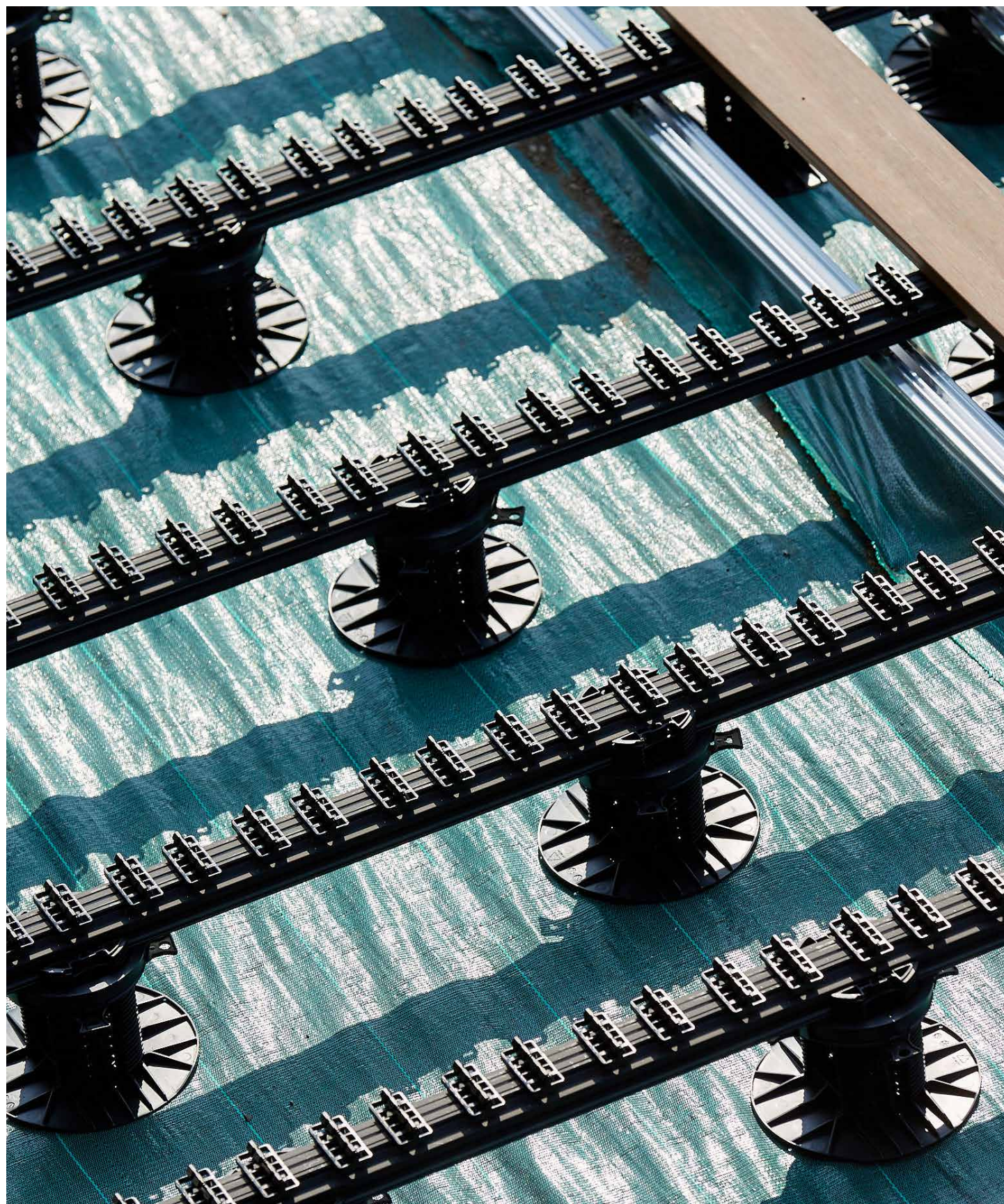

FLAT RAIL

Non load-bearing rail for decking and cladding.

REF	DESCRIPTION	QTY/PALLET	COMPATIBILITY
1185	FLAT RAIL - 124 32 clips for 16 boards of 120 mm. 12 x 55 x 1984 mm. Non load-bearing.	216 pcs	Accoya®, Kebony®, Moso®, Thermo-Ash, Thermo-Pine
2222	FLAT RAIL - 124 24 clips for 12 boards of 120 mm. 12 x 55 x 3968 mm. Non load-bearing.	216 pcs	
2031	FLAT RAIL - 145 26 clips for 13 boards of 140 mm. 12 x 55 x 1885 mm. Non load-bearing.	216 pcs	UPM
1186	FLAT RAIL - 150 26 clips for 13 boards of 145 mm. 12 x 55 x 1950 mm. Non load-bearing.	216 pcs	Nekko
1860	FLAT RAIL - 155,5 24 clips for 12 boards of 150 mm. 12 x 55 x 1866 mm. Non load-bearing.	216 pcs	Dex
1724	FLAT RAIL WITHOUT CLIPS For tapered boards. 12 x 55 x 1984 mm. Non load-bearing.	216 pcs	

TECHNICAL CHARACTERISTICS

Rail material	Aluminium 6060
Rail finish	Black paint
Clip material	Polyoxymethylene (POM)
Rail weight (including clips)	+/- 0,630 kg/m
Maximum Length	3968 mm
Pull-out strength of the clip on the rail	150 to 250 kg, for two clips (depending on the type of board)

- **Non load-bearing rail** to be fixed on hard floor or solid ground
- Thin
- Clips are factory-placed onto the rail for perfect drainage lines
- Each board can be removed individually with dismantling keys adapted to the width of the board
- Rail can be cut to length
- No contact between the boards and the aluminium rail for better air flow
- Invisible fastening
- Simple, quick and ergonomic installation
- Endless possibilities
- 100% recyclable
- Taylor-made rails on demand: for your specific project, custom rails can be designed and produced. Feasibility and conditions on request. Minimum quantity per order to be advised.

TOP RAIL

Rail with integrated pedestals for decking.



Top Rail

REF	DESCRIPTION	QTY/PALLET	COMPATIBILITY
1189	TOP RAIL PR24 - 124 32 clips for 16 boards of 120 mm. 24 x 63 x 1984 mm. Integrated pedestals.	120 pcs	Accoya®, Kebony®, Moso®, Thermo-Ash, Thermo-Pine
2032	TOP RAIL PR24 - 145 26 clips for 13 boards of 140 mm. 24 x 55 x 1885 mm. Integrated pedestals.	120 pcs	UPM
1190	TOP RAIL PR24 - 150 26 clips for 13 boards of 145 mm. 24 x 55 x 1950 mm. Integrated pedestals.	120 pcs	Nekko
1971	TOP RAIL PR24 - 155,5 24 clips for 12 boards of 150 mm. 24 x 55 x 1866 mm. Integrated pedestals.	120 pcs	Dex

TECHNICAL CHARACTERISTICS

Rail material	Aluminium 6060
Rail finish	Black paint
Clip material	Polyoxymethylene (POM)
Rail weight (including clips)	+/- 1,18 kg/m
Maximum Length	1984 mm
Pull-out strength of the clip on the rail	150 to 250 kg, for two clips (depending on the type of board)

- **For private use only**
- Load-bearing rail with integrated pedestals
- Clips are factory-placed onto the rail for perfect drainage lines
- Each board can be removed individually with dismantling keys adapted to the width of the board
- Rail can be cut to length
- No contact between the boards and the aluminium rail for better air flow
- Invisible fastening
- Simple, quick and ergonomic installation
- Endless possibilities
- 100% recyclable
- Taylor-made rails on demand: for your specific project, custom rails can be designed and produced. Feasibility and conditions on request. Minimum quantity per order to be advised.

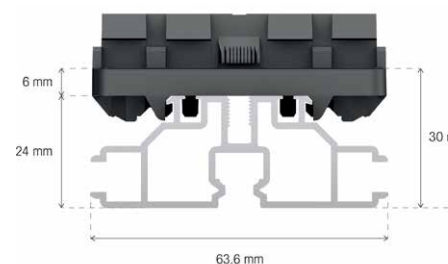
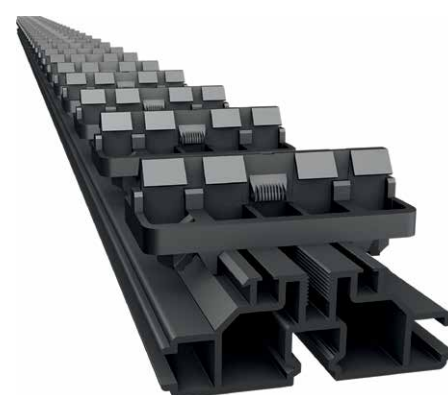

PR24

Load-bearing rail for decking.

PR24

REF	DESCRIPTION	QTY/PALLET	COMPATIBILITY
1191	PR24 - 124 32 clips for 16 boards of 120 mm. 24 x 55 x 1984 mm.	108 pcs	Accoya®, Kebony®, Moso®, Thermo-Ash, Thermo-Pine
1997	PR24 - 124 64 clips for 32 boards of 120 mm. 24 x 55 x 3968 mm.	108 pcs	
2033	PR24 - 145 26 clips for 13 boards of 140 mm. 24 x 55 x 1885 mm.	108 pcs	UPM
1192	PR24 - 150 26 clips for 13 boards of 145 mm. 24 x 55 x 1950 mm.	108 pcs	Nekko
1970	PR24 - 155,5 24 clips for 12 boards of 150 mm. 24 x 55 x 1866 mm.	108 pcs	Dex
1782	PR24 WITHOUT CLIPS For tapered boards. 24 x 55 x 1984 mm.	108 pcs	

TECHNICAL CHARACTERISTICS

Rail material	Aluminium 6060
Rail finish	Black paint
Clip material	Polyoxymethylene (POM)
Rail weight (including clips)	+/- 1,05 kg/m
Maximum Length	3968 mm
Pull-out strength of the clip on the rail	150 to 250 kg, for two clips (depending on the type of board)

- Load-bearing rail, pedestal spacing up to 38 cm for private use.
- Clips are factory-placed onto the rail for perfect drainage lines
- Each board can be removed individually with dismantling keys adapted to the width of the board
- Rail can be cut to length
- No contact between the boards and the aluminium rail for better air flow
- Invisible fastening
- Simple, quick and ergonomic installation
- Endless possibilities
- 100% recyclable
- Taylor-made rails on demand: for your specific project, custom rails can be designed and produced. Feasibility and conditions on request. Minimum quantity per order to be advised.

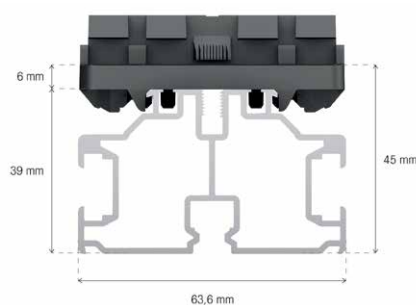

PR39

Load-bearing rail for decking.

PR39

REF	DESCRIPTION	QTY/PALLET	COMPATIBILITY
1194	PR39 - 124 32 clips for 16 boards of 120 mm. 39 x 55 x 1984 mm.	108 pcs	Accoya®, Kebony®, Moso®, Thermo-Ash, Thermo-Pine
1194	PR39 - 124 64 clips for 32 boards of 120 mm. 39 x 55 x 3968 mm.	108 pcs	
2034	PR39 - 145 26 clips for 13 boards of 140 mm. 39 x 55 x 1885 mm.	108 pcs	UPM
1193	PR39 - 150 26 clips for 13 boards of 145 mm. 39 x 55 x 1950 mm.	108 pcs	Nekko
1861	PR39 - 155,5 24 clips for 12 boards of 150 mm. 39 x 55 x 1866 mm.	108 pcs	Dex
1781	PR39 WITHOUT CLIPS For tapered boards. 39 x 55 x 1984 mm.	108 pcs	

TECHNICAL CHARACTERISTICS

Rail material	Aluminium 6060
Rail finish	Black paint
Clip material	Polyoxymethylene (POM)
Rail weight (including clips)	+/- 1,40 kg/m
Maximum Length	3968 mm
Pull-out strength of the clip on the rail	150 to 250 kg, for two clips (depending on the type of board)

- Load-bearing rail, pedestal spacing up to 70 cm for private use.
- Clips are factory-placed onto the rail for perfect drainage lines
- Each board can be removed individually with dismantling keys adapted to the width of the board
- Rail can be cut to length
- No contact between the boards and the aluminium rail for better air flow
- Invisible fastening
- Simple, quick and ergonomic installation
- Endless possibilities
- 100% recyclable
- Taylor-made rails on demand: for your specific project, custom rails can be designed and produced. Feasibility and conditions on request. Minimum quantity per order to be advised.

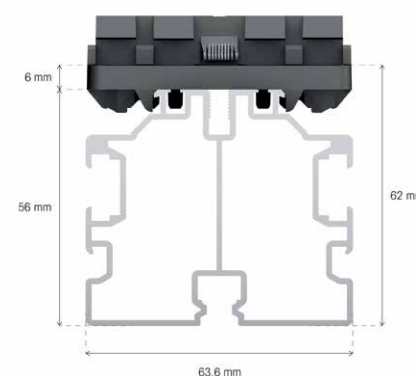

PR56

Load-bearing rail for decking.

PR56

REF	DESCRIPTION	QTY/PALLET	COMPATIBILITY
1197	PR56 - 124 32 clips for 16 boards of 120 mm. 56 x 55 x 1984 mm.	108 pcs	Accoya®, Kebony®, Moso®, Thermo-Ash, Thermo-Pine
1197	PR56 - 124 64 clips for 32 boards of 120 mm. 56 x 55 x 3968 mm.	108 pcs	
2035	PR56 - 145 26 clips for 13 boards of 140 mm. 56 x 55 x 1885 mm.	108 pcs	UPM
1196	PR56 - 150 26 clips for 13 boards of 145 mm. 56 x 55 x 1950 mm.	108 pcs	Nekko
1972	PR56 - 155,5 24 clips for 12 boards of 150 mm. 56 x 55 x 1866 mm.	108 pcs	Dex
1644	PR56 WITHOUT CLIPS For tapered boards. 56 x 55 x 1984 mm.	108 pcs	

TECHNICAL CHARACTERISTICS

Rail material	Aluminium 6060
Rail finish	Black paint
Clip material	Polyoxymethylene (POM)
Rail weight (including clips)	+/- 1,70 kg/m
Maximum Length	3968 mm
Pull-out strength of the clip on the rail	150 to 250 kg, for two clips (depending on the type of board)

- Load-bearing rail, pedestal spacing up to 120 cm for private use.
- Clips are factory-placed onto the rail for perfect drainage lines
- Each board can be removed individually with dismantling keys adapted to the width of the board
- Rail can be cut to length
- No contact between the boards and the aluminium rail for better air flow
- Invisible fastening
- Simple, quick and ergonomic installation
- Endless possibilities
- 100% recyclable
- Taylor-made rails on demand: for your specific project, custom rails can be designed and produced. Feasibility and conditions on request. Minimum quantity per order to be advised.



TOP LIFT® + ACCESSORIES

REF	DESCRIPTION	QTY/PALLET	GROUND COMPATIBILITY
1661	TOP LIFT® - ADJUSTABLE PEDESTAL Adjustable between 35 and 55 mm. Without boosters. Possibility to increase up to 190 mm with the assembled boosters. Box of 40 pieces.	24 boxes	
1495	UP+ - BOOSTERS FOR TOP LIFT® Adds 45 mm per pair of assembled boosters. Box of 40 pairs.	96 boxes	Hard Stabilized Rooftop
1499	TOP+ - STABILIZERS FOR TOP LIFT® To stabilize the pedestal with over 3 pairs of boosters. Box of 80 pieces.	24 boxes	
1496	SLOPE CORRECTOR To compensate up to 4% slope Box of 250 pieces	n/a	

- A screw mechanism to adjust the levelness of your deck with precision.
- 100% recyclable polypropylene
- Resistant to compression
- Adjustable range from 35 to 190 mm, thanks to the boosters (and up to 325 mm with the TOP+ stabilizers)
- A slope corrector can be added to compensate up to 4%.
- 100% made in France

A unique polymer pedestal that guarantees a perfectly flat structure! We recommend that Top Lift® be used with a waterproof membrane, as the membrane will prevent the pedestals from sinking into the ground over time.

It supports an average load of one ton/m² (800 kg/pc) and allows for easy level adjustment thanks to its very precise screw system.

With a support surface of more than 300 cm², it meets standards of decks built on waterproof membranes.



Base model:
35 to 55 mm

Base model with 1
pair of boosters:
up to 100 mm

Base model with 2
pairs of boosters:
up to 145 mm

Base model with 3
pairs of boosters:
up to 190 mm

Base model with up
to 6 pairs of boosters
and stabilizers:
325+ mm



FINISHING TOUCHES

WOOD SKIRTING



In continuing our decking innovations, our Research and Development team have developed a system for the easy installation of wood skirting. Thanks to the Top Cube®, it is possible to equip the PR39 and PR56 rails with a support for skirting up to three boards high. The finishing touches of your project come together quickly and with a perfect result every time.

ALUMINIUM SKIRTING

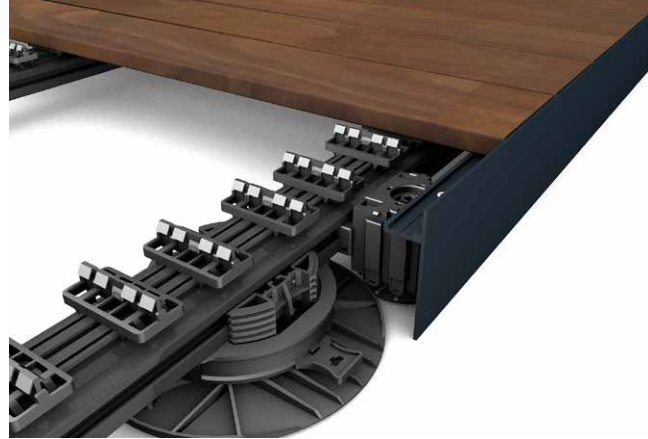



















In case of contact with the ground, the installation of a wooden skirting is not sustainable. In order to meet these constraints, we have developed an extruded aluminium strip that is compatible with the Top Cube®. Once installed, it creates a perfect finish that is as durable as it is beautiful.



TOP CUBE + FINISHING TOUCHES

	REF	DESCRIPTION	QTY/PALLET	SKIRTING COMPATIBILITY
	1498	TOP CUBE® For skirting assembly. Only with PR39 or PR56. With pedestal and screws. Bag of 4 pcs.	20 bags	Wood Aluminium
	1473	Skirting Support - B1. To fix on TOP CUBE®, for 120 mm width boards. With 2 stainless steel screws. Box of 25 pcs.	16 boxes	Wood
	1474	Skirting Support - B2. To fix on TOP CUBE®, for 2 x 120 mm width boards. With 2 stainless steel screws. Box of 25 pcs.	8 boxes	Wood
	1476	Skirting Support - B3. To fix on TOP CUBE®, for 3 x 120 mm width boards. With 4 stainless steel screws. Box of 25 pcs.	8 boxes	Wood
	1486	Grad® Wedge Clip With fixing screw. Bag of 20 pieces.	25 bags	Wood Aluminium
	1504	Linking plate for skirting. With clips - A2 stainless steel. Dims: 120 x 30 x 1.5mm. Bag of 4 pcs.	20 bags	Wood
	1218	Self-tapping screws - A2 stainless steel. Diam. 4 x 35 mm. Torx. To fix skirting	1 box of 200 pcs	Wood Aluminium
	967	TOUR Aluminium skirting. Dims: 4,5 x 37 x 2009 mm. With fixing system.	15 pcs	Aluminium
	1481	Flat fixing bracket 90° angles. With fixing system. Bag of 2 pcs.	20 bags	Wood Aluminium
	1206	Aluminium skirting. RAL 7016, height: 10 cm, length: 3,75 m. Bag of 2 pcs.	20 bags	Aluminium
	1205	Aluminium skirting. RAL 7016, height: 15 cm, length: 3,75 m. Bag of 2 pcs.	20 bags	Aluminium
	2637	Aluminium skirting. RAL 7016, height: 15 cm, length: 3,75 m. Bag of 2 pcs. For boards with thickness from 24 to 28 mm.	20 bags	Aluminium
	1518	Self-tapping screws - A2 stainless steel. Diam. 4,8 x 38 mm. Torx. Bag of 50 pcs.	20 bags	Wood Aluminium
	1485	Grad® Half Clip Bag of 50 pcs.	20 bags	Wood Aluminium
	2175	Adaptable Skirting Support - B1 Fastened to the Top Cube® For one panel, widths 140 - 155 mm. Box of 25 pieces	16 boxes	Wood
	2176	Adaptable Skirting Support - B2 Fastened to the Top Cube® For two panels, widths 140 - 155 mm. Box of 25 pieces	8 boxes	Wood

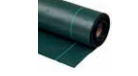
MISCELLANEOUS ACCESSORIES

REF	DESCRIPTION	QTY/PALLET
	Perforated ventilation grid Anodized aluminium. Ensures ventilation. 20,5 x 119 x 2 000 mm. Sold per 1 unit.	1 pc
	Grad® Clip Without lugs. To position at angles, with M5/12 mm screw A2 stainless steel. Twist. Bag of 50 pieces.	20 bags
	TOP LINK S For linking rail ends together, for 120 mm boards. Polyoxymethylene, black. Bag of 20 pcs.	10 bags
	TOP LINK L For linking rail ends together, for 145 or 155 mm boards. Polyoxymethylene, black. Bag of 20 pcs.	10 bags
	Spanner With 5 clips. CC: 500 mm. Rail dims: 26 x 50 x 2060 mm. Sold per 1 unit.	72 pcs
	Spanner With 5 clips. CC: 463 mm. Rail dims: 26 x 50 x 1910 mm. Sold per 1 unit. Only for Moso® X-treme® Bamboo (in 120/155 mm).	72 pcs
	Spanner With 5 clips. CC: 400 mm. Rail dims: 26 x 50 x 1910 mm. Sold per 1 unit. Exclusively for Dex and UPM	72 pcs
	Removable Grad® Clip. Polyoxymethylene, black. With lugs. Bag of 50 pcs.	20 bags
	Fixing Bracket with Installation Kit for PR 39 or PR 56. 47 x 30 x 16 mm. Stainless steel A2.. Bag of 4 kits.	32 bags
	DISMANTLING KEYS Keys to remove 120 mm boards. Pair of keys.	6 pairs
	DISMANTLING KEYS Keys to remove 145 to 155 mm boards. Pair of keys.	10 pairs
	Self-Tapping Screws. A2 stainless steel. Torx. Diam. 4 x 35 mm for FLAT RAIL onto wood.	1 box of 200 pcs
	Nail Anchor. Diam. 6 x 60mm for FLAT RAIL onto concrete.	1 box of 50 pcs
	Countersunk Bichro Screw. Diam. 6 x 120 mm. Torx.	1 box of 100 pcs
	Rubber Strip 2 mm thickness. 55 x 11 000 x 2 mm. Sold by the roll.	10 pcs
	Rubber Strip 4 mm thickness. 55 x 16 000 x 4 mm. Sold by the roll.	10 pcs
	Woven-Fibre Textile. Dimensions: 1.5 x 25 m. Roll of 37,5 m ² .	90 pcs
	Glue Only for composite boards. 290 ml.	1 pc
	Glue Only for wood boards. 310 ml.	1 pc

MAINTENANCE



Unlike most materials, such as stone, concrete or tiles, wood is not an unchanging material.

Even when cut into boards, planed and dried, wood retains the traces and characteristics of its plant origin. For example, a tree on the edge of a forest, which has been exposed to the prevailing winds, will produce planks whose behaviour and density will not be identical to others!

This memory of the fibres, added to the sometimes spectacular variations in width according to the ambient humidity level, constitutes what is commonly summarized by the expression "woodworking".

The horizontal exposure of a piece of wood to climatic changes, during the four seasons of the year, represents very violent stresses for this material.

Through the choice of the species we use, through our installation techniques, but above all through processing beforehand (thermal modification, acetylation or furfurylation), we manage to avoid problems that would make the deck unfit for use, and even to guarantee life spans that exceed anything imaginable even 10 years ago.

In order to improve the comfort of use of your deck and to guarantee the durability of the coverings, Grad® recommends that you service your wood decking at least twice a year.

For more information, you can find our maintenance guide at: www.gradconcept.com

MAINTENANCE PRODUCTS

REF	DESCRIPTION	QTY/PALLET	BOARD COMPATIBILITY
	D-CLEAN Cleaner for all boards 3 kg per can, about 90m ² per can For semi-annual maintenance Environmentally-friendly	1 pc	Kebony®, Moso®, Thermo-Ash, Thermo-Pine
	D-NEW Reviver for all types of wood decking 3kgs per can, about 30m ² per can	1 pc	Kebony®, Moso®, Thermo-Ash, Thermo-Pine
	PROTEXT Wood stain. Honey color. 5 litres. 50 to 60 m ² per can. Once a year minimum- brush application	1 pc	Kebony®, Thermo-Ash, Thermo-Pine
	CETOL WF TT1 Wood stain for Moso Bamboo®. 2.5 L about 25 m ² per can. At installation + once per year minimum - brush application	1 pc	Moso®

GRAD® FOR CERAMIC TILES

STRAIGHT LINES.
OPTIMAL
STABILITY.



PERFECT TILE
ALIGNMENT.

SUPPORT TILES WITH A
SOUND-DAMPENING CUSHION.

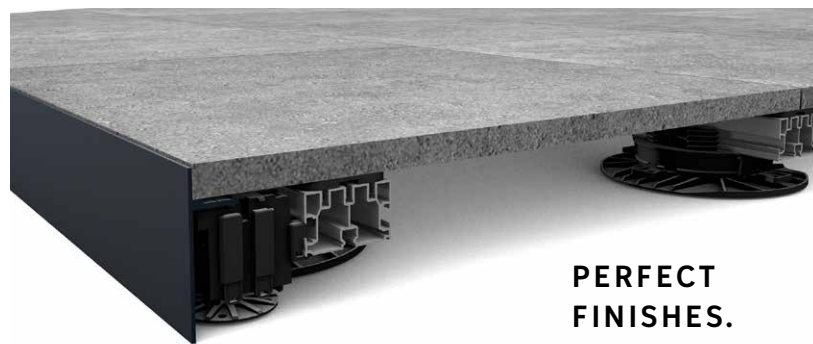

PERFECT
FINISHES.

HARD GROUND



STABILISED GROUND

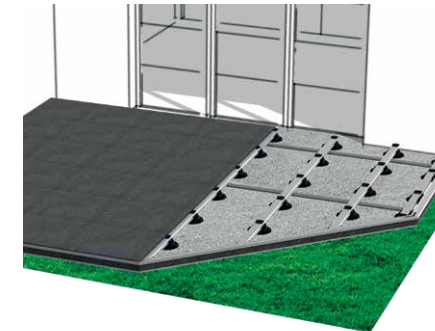

ROOFTOP

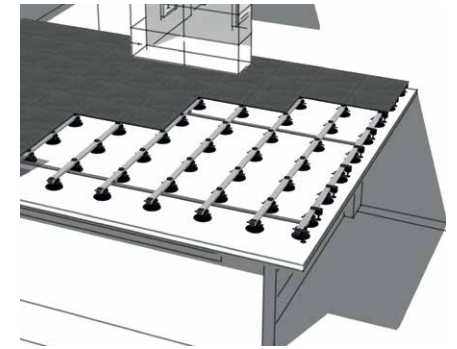

ON RUBBER STRIPS

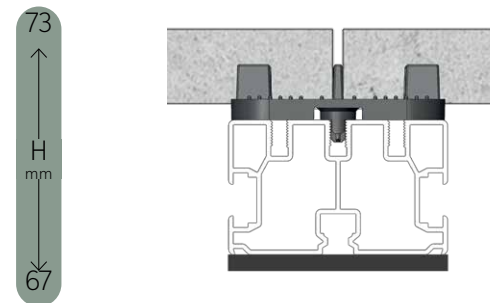

ON TOP LIFT®

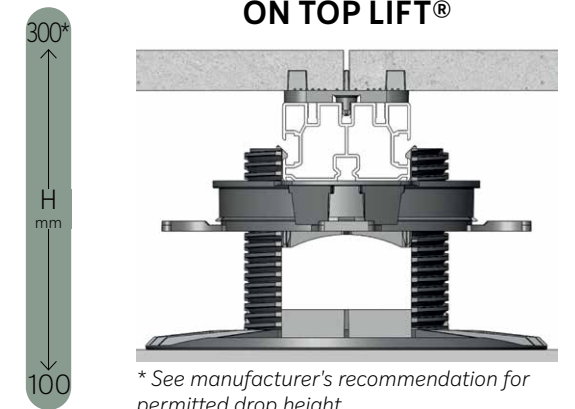

* See manufacturer's recommendation for permitted drop height

Mixed wood and ceramic decking

Combining the warmth of wood with the resistance of ceramic stoneware makes it possible to dedicate areas of the terrace to the most appropriate uses (i.e. dining or relaxation area). Thanks to the Grad® system, it is possible to easily combine



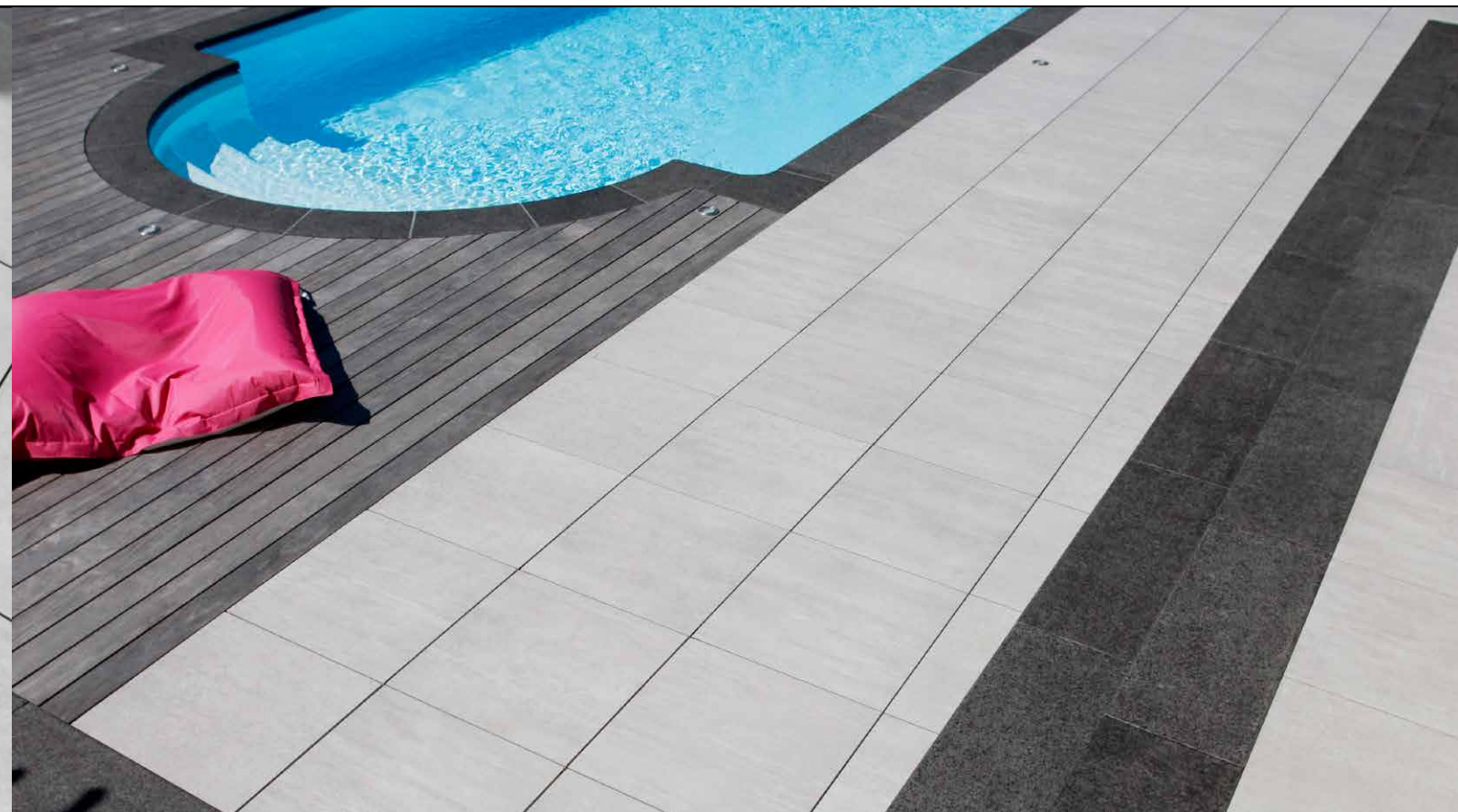
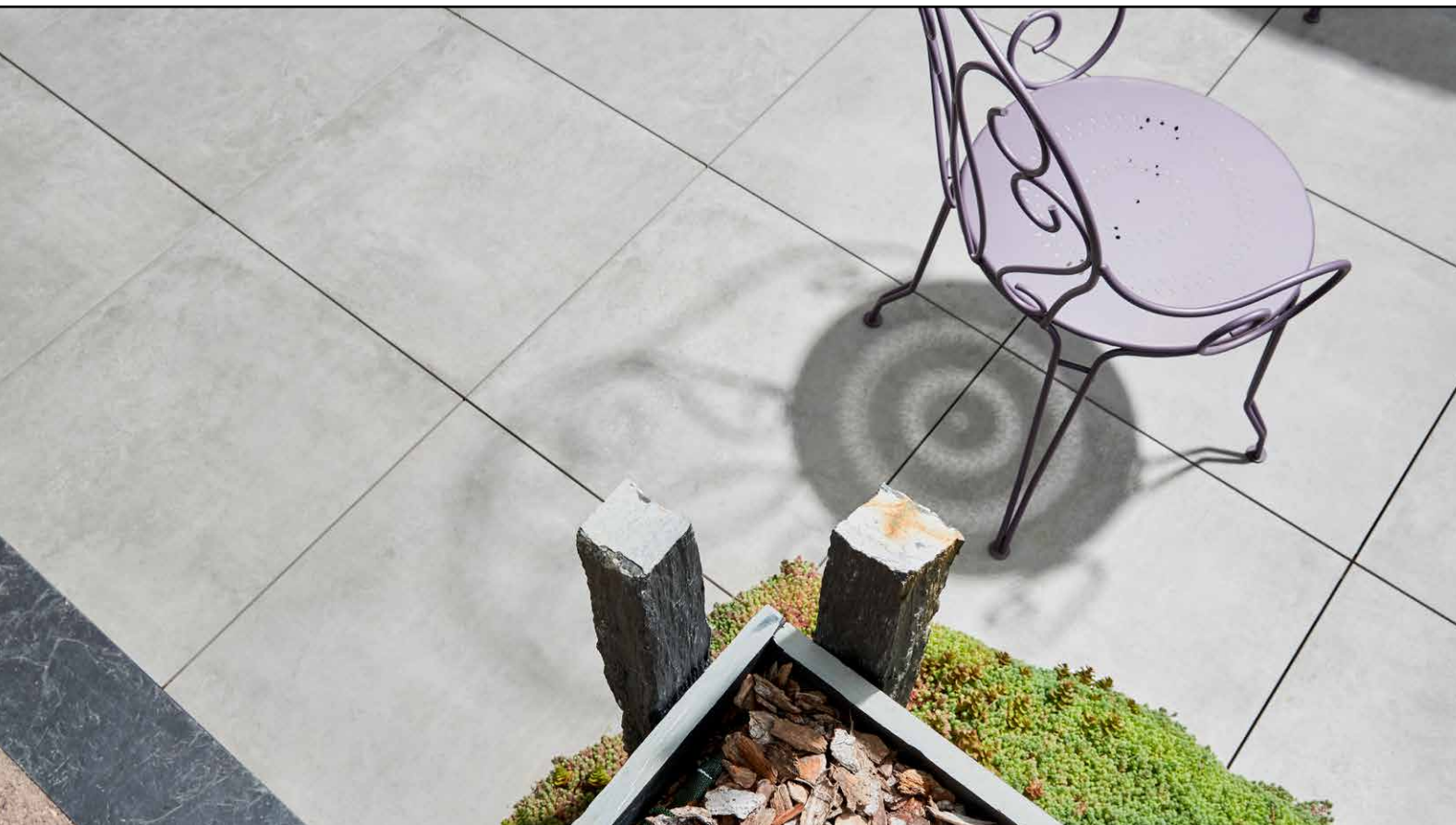

ceramic tiles and wood structures. Our range of accessories allows to efficiently connect the aluminium profiles in order to ensure a homogeneous structure. The ceramic stoneware and wood parts are then stable and solid.



STONE RAIL + ACCESSORIES

	REF	DESCRIPTION	QTY/PALLET
	1209	STONE RAIL 63 x 39 x 3600 mm.	72 pcs
	1494	Tile Supports Box of 100 pieces.	8 boxes
	1241	Countersunk Stainless Steel Screw A2 M5/12 mm. Torx Bag of 50 pieces.	1 bag
	1492	Cushioning Pad Foam, 3 mm thick. Bag of 100 pieces.	8 bags
	1524	Rail Spanner for Stone Rail With 6 clips. 26 x 50 x 3650 mm. Spacing 598 mm. Per piece.	72 pcs
	1483	Removable Grad® Clip. Polyoxymethylene, black. With lugs. Bag of 50 pcs.	20 bags
	1503	Fixing Bracket with Installation Kit for PR 39 or PR 56. 47 x 30 x 16 mm. Stainless steel A2.. Bag of 4 kits.	32 bags
	1220	Rubber Strip 2 mm thickness. 55 x 11 000 x 2 mm. Sold by the roll.	10 pcs
	1221	Rubber Strip 4 mm thickness. 55 x 16 000 x 4 mm. Sold by the roll.	10 pcs

TOP LIFT® + ACCESSORIES

	REF	DESCRIPTION	QTY/PALLET	GROUND COMPATIBILITY
	1661	TOP LIFT® - Adjustable Pedestal Adjustable between 35 and 55 mm. Without boosters. Possibility to increase up to 190 mm with the assembled boosters. Box of 40 pieces.	24 boxes	
	1495	UP+ - Boosters for TOP LIFT® Adds 45 mm per pair of assembled boosters. Box of 40 pairs.	96 boxes	Hard Stabilized Rooftop
	1499	TOP+ - stabilizers for TOP LIFT® To stabilize the pedestal when used with over 3 pairs of boosters. Box of 80 pieces.	24 boxes	
	1496	Slope Corrector To compensate up to 4% slope Box of 250 pieces	n/a	





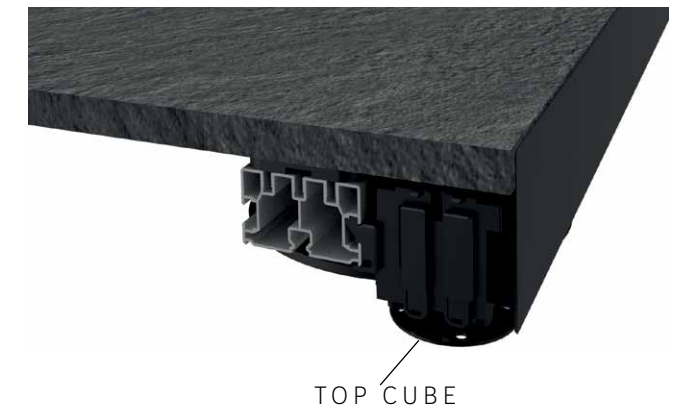

CERAMIC TILE SKIRTING

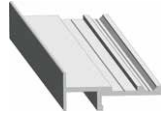
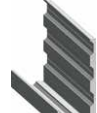

ALUMINIUM SKIRTING



TOP CUBE® + SKIRTING

	REF	DESCRIPTION	QTY/PALLET
	1498	TOP CUBE® For Skirting Assembly. Only with PR 39 or PR 56. With pedestals and screws. Bag of 4 pcs.	20 bags
	1208	Upper Rail for Ceramic Tile Skirting. Only for installation on hard ground. Anodized aluminium. 67,3 x 26 x 3620 mm. Per piece.	20 pcs
	1207	Lower Rail for Ceramic Tile Skirting. Only for installation on hard ground. Anodized aluminium. 67,3 x 26 x 3620 mm. Per piece.	20 pcs
	1481	90 Degree Flat Bracket. With fixing screw. Bag of 2 pieces.	20 bags
	1482	135 Degree Flat Bracket. With fixing screw. Bag of 2 pieces.	20 bags
	1206	Aluminium Skirting. RAL 7016, height: 10 cm , length: 3,75 m. Bag of 2 pcs.	20 bags
	1205	Aluminium Skirting. RAL 7016, height: 15 cm , length: 3,75 m. Bag of 2 pcs.	20 bags
	1518	Self-Tapping Countersunk Screw - Stainless Steel A2. Ø 4,8 x 38 mm. Torx. Bag of 50 pieces.	20 bags
	1241	Countersunk Screw M5 / 12 mm. Stainless steel, A2. Torx.	1 box of 50 pcs



→ 03

DECKING BOARDS

Decking boards in stock

Our partners
Special orders





KEBONY®

*Radiata Pine.
Furfurylation treatment.*

Injection of products from plant components that reinforce the wood body to increase its density, durability and stability.

**Wood from FSC certified plantations.
Little expansion or shrinkage of the wood.
Very high resistance to weathering.
Wood species with very few knots.**

Class 4 equivalent.

Comfort profile: planed wood with a slightly curved effect on the top to allow water drainage.



© Rieger Garten



© Kebony



© Extérieur Sud



© The Outdoor Deck Company

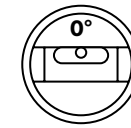
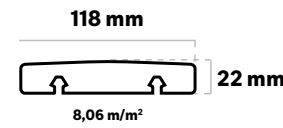

KEBONY®		QTY/UNIT
LENGTH 1,50 M	1993	per unit
LENGTH 2,10 M	2489	108 pcs
LENGTH 2,40 M	1310	108 pcs
LENGTH 3,00 M	1311	108 pcs
LENGTH 3,60 M	1312	108 pcs
LENGTH 4,20 M	1313	108 pcs
LENGTH 4,80 M	1314	108 pcs

COMPATIBILITY

REF	DESCRIPTION
1185	Flat Rail - 124
2222	Flat Rail - 124
1189	Top Rail - 124
1191	PR24 - 124
1194	PR39 - 124
1197	PR56 - 124

WEATHERING

AT INSTALLATION

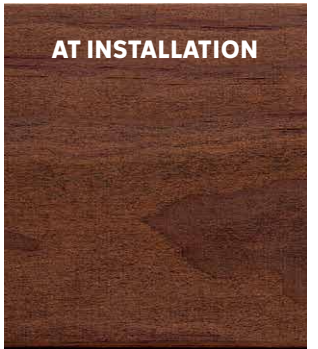

6 MONTHS

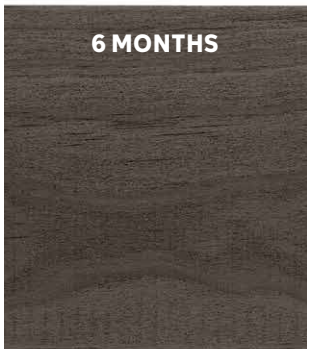

1 YEAR



- Maximum spacing for private use 50 cm
- Subject to availability
- Photos are non-contractual
- Public sector: please contact us

Up to **30 year warranty**, according to manufacturer's conditions. More features and quality criteria available on our website www.gradconcept.com



MOSO®

High density compressed bamboo strips.

Available in two finishes: Bamboo X-Treme and Bamboo N-Durance

High durability and fire resistance.

Puncture & abrasion resistance

The ecological alternative to the use of tropical wood.

Ideal for public sites.

Factory applied stain.

No knots.

Bamboo X-Treme is heat treated at 200°C

Equivalent class 4 - Durability class 0 (no fungal attacks)

Comfort profile: planed wood with a slightly curved effect on the top to allow water evacuation.



© Grad



© Vert'ige Elagage



© Moso



© Grad

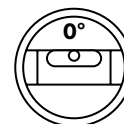
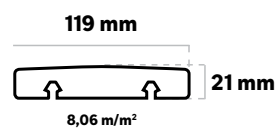

MOSO® X-TREME	QTY/UNIT
LENGTH 1,85 M	2022 234 pcs
MOSO® N-DURANCE	QTY/UNIT
LENGTH 1,85 M	2104 234 pcs

COMPATIBILITY

REF	DESCRIPTION
1185	Flat Rail - 124
2222	Flat Rail - 124
1189	Top Rail - 124
1191	PR24 - 124
1194	PR39 - 124
1197	PR56 - 124

WEATHERING

AT INSTALLATION



6 MONTHS



2 YEARS



→ **Maximum spacing for private use 46.2 cm**

→ Subject to availability

→ Photos are non-contractual

→ Public sector: please contact us

Up to **25 year warranty**, according to manufacturer's conditions. More features and quality criteria available on our website www.gradconcept.com



THERMO-PINE

Thermally modified pine, heated to 215°C

This treatment makes the wood more stable and rot-proof. Treatment without addition of chemicals.

A very nice and homogeneous silver patina appears over time and with UV exposure.

European wood.
Minimal expansion or shrinkage of the wood.
Low density: high insulating power.
From 2 to 5 knots per linear meter.

Class 3 equivalent.

Comfort profile: planed wood with a slightly curved effect on the top to allow water drainage.

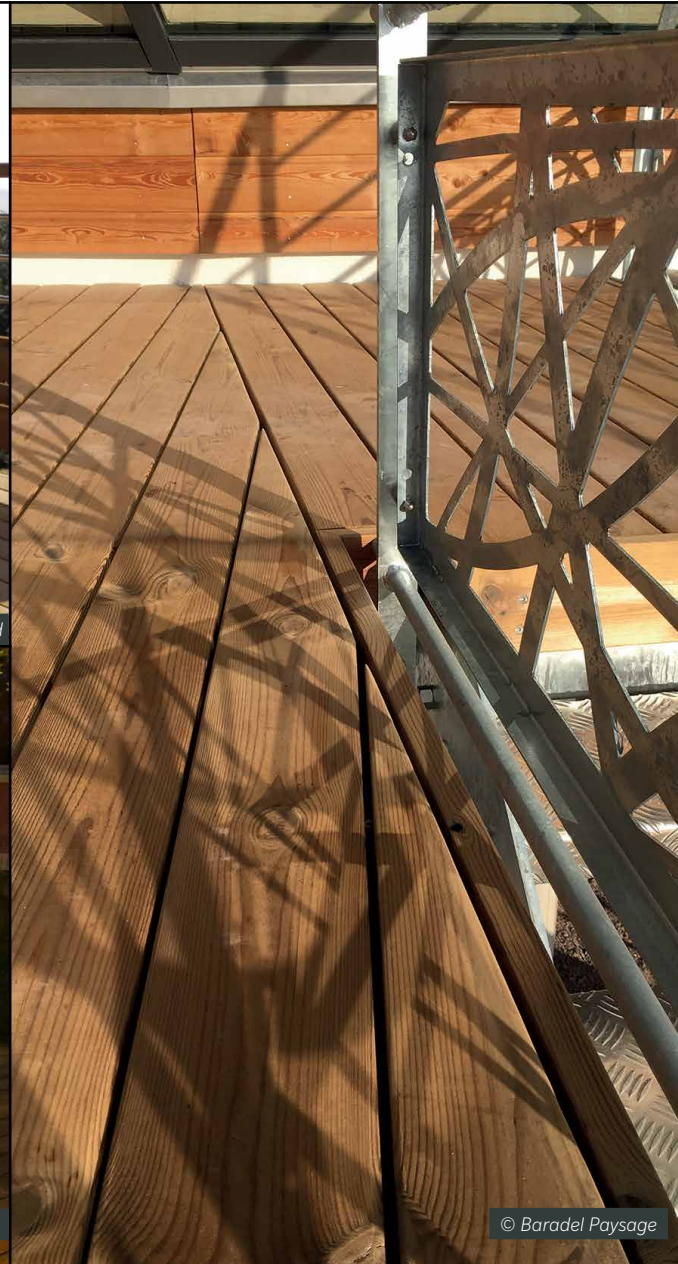

WEATHERING

AT INSTALLATION



6 MONTHS



1 YEAR

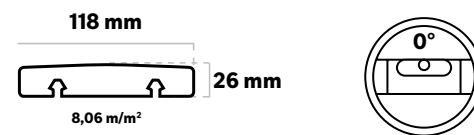

COMPATIBILITY

REF	DESCRIPTION
1185	Flat Rail - 124
2222	Flat Rail - 124
1189	Top Rail - 124
1191	PR24 - 124
1194	PR39 - 124
1197	PR56 - 124

THERMO-PINE		QTY/UNIT
LENGTH 3,00 M	1302	351 pcs
LENGTH 3,60 M	1303	351 pcs
LENGTH 4,20 M	2104	351 pcs
LENGTH 4,80 M	1306	351 pcs

- Maximum spacing for private use 50 cm
- Subject to availability
- Photos are non-contractual
- Public sector: please contact us

Up to **15 year warranty**, according to manufacturer's conditions. More features and quality criteria available on our website www.gradconcept.com

THERMO-ASH

Thermally modified ash, heated to 215°C

This treatment makes the wood more stable and rot-proof. Treatment without addition of chemicals.

A very nice and homogeneous silver patina appears over time and with UV exposure.

European wood.
Minimal expansion or shrinkage of the wood.
Low density: high insulating power.
Naturally very few knots.

Class 4 equivalent.

Comfort profile: planed wood with a slightly curved effect on the top to allow water drainage.

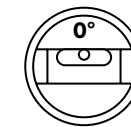
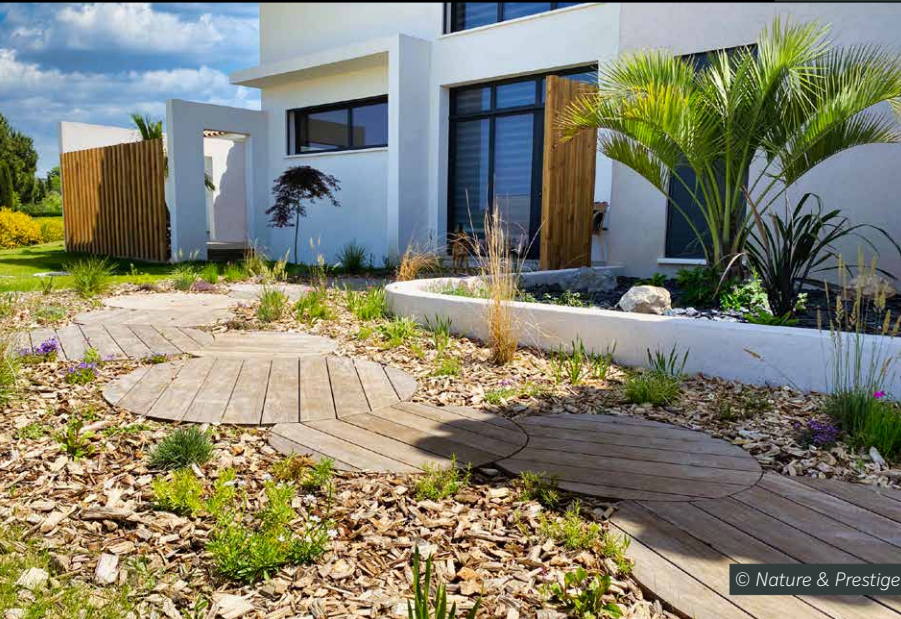
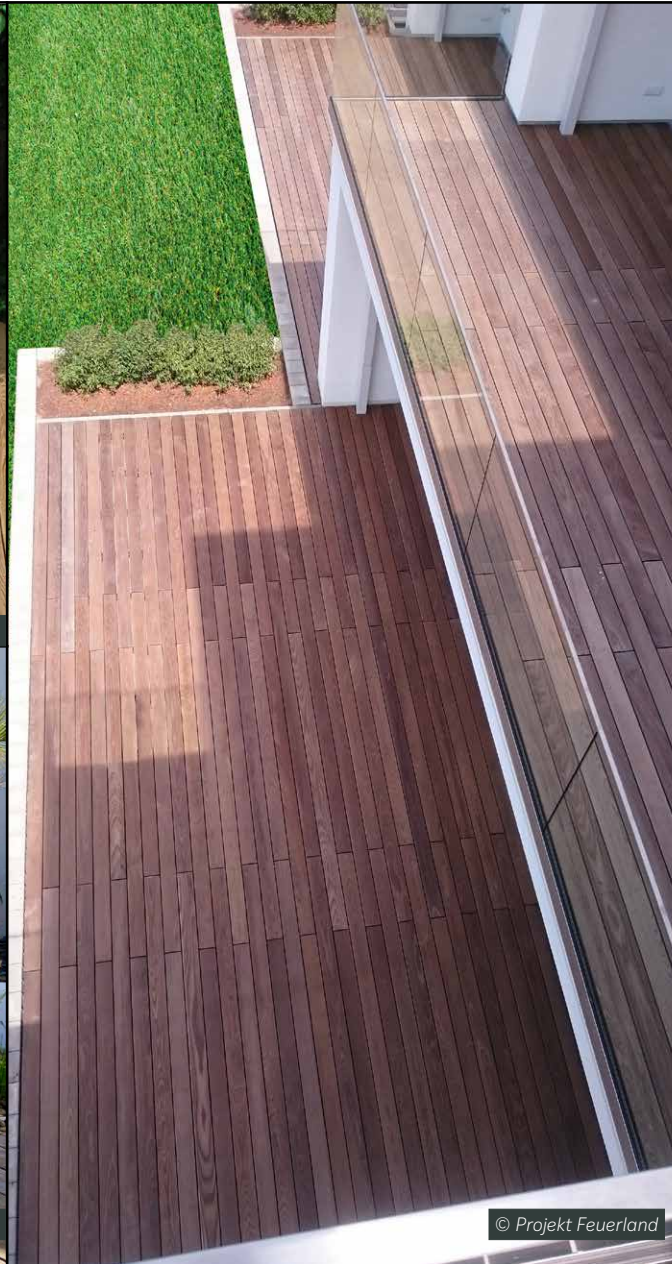

THERMO-ASH

		QTY/UNIT
LENGTH 1,50 M	1650	360 pcs
LENGTH 2,10 M	1796	216 pcs
LENGTH 2,40 M	1297	216 pcs
LENGTH 2,70 M	1298	216 pcs
LENGTH 3,00 M	1299	216 pcs

COMPATIBILITY

REF	DESCRIPTION
1185	Flat Rail - 124
2222	Flat Rail - 124
1189	Top Rail - 124
1191	PR24 - 124
1194	PR39 - 124
1197	PR56 - 124

- Maximum spacing for private use 50 cm
- Subject to availability
- Photos are non-contractual
- Public sector: please contact us

Up to **20 year warranty**, according to manufacturer's conditions. More features and quality criteria available on our website www.gradconcept.com

WEATHERING

AT INSTALLATION



6 MONTHS



1 YEAR



© Air & Soleil

© Nature & Prestige

© Projekt Feuerland

© Nature & Prestige



ACCOYA®

*Radiata Pine. Treatment by acetylation.
Available in two finishes: natural and grey*

Without addition of chemicals; transformation of OH molecules into acetyl molecules which have the distinct property of not binding to water molecules.

Wood from FSC certified plantations. Class 4.
Since 2017, Accoya® has been certified **Cradle-to-Cradle**, "platinum" level, which evaluates the eco-design of a product, taking into account its ability to be recycled.

Extremely stable wood: average tangential stability coefficient of 1.5%.
Very rare knots

Comfort profile: planed wood with a slightly curved effect on the top to allow water drainage.



© Woodstone



© Grad



© Pauchard Paysage



© Pauchard Paysage

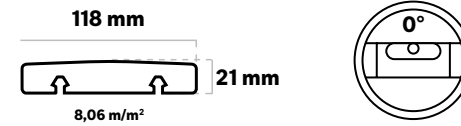

ACCOYA® NATURAL		QTY/UNIT
LENGTH 1,50 M	1990	per unit
LENGTH 2,10 M	2591	108 pcs
LENGTH 2,40 M	1328	108 pcs
LENGTH 3,00 M	1318	108 pcs
LENGTH 3,60 M	1319	108 pcs
LENGTH 4,20 M	1320	108 pcs
LENGTH 4,80 M	1321	108 pcs

ACCOYA® GREY		QTY/UNIT
LENGTH 1,50 M	2620	per unit
LENGTH 2,10 M	2586	108 pcs
LENGTH 2,40 M	2585	108 pcs
LENGTH 3,00 M	1324	108 pcs
LENGTH 3,60 M	1325	108 pcs
LENGTH 4,20 M	1326	108 pcs
LENGTH 4,80 M	1330	108 pcs

COMPATIBILITY	
REF	DESCRIPTION
1185	Flat Rail - 124
2222	Flat Rail - 124
1189	Top Rail - 124
1191	PR24 - 124
1194	PR39 - 124
1197	PR56 - 124

WEATHERING



- Maximum spacing for private use 50 cm
- Subject to availability
- Photos are non-contractual
- Public sector: please contact us

Up to **50 year limited warranty**, according to manufacturer's conditions. More features and quality criteria available on our website www.gradconcept.com



NEKKO

Co-extruded composite.
Available in two finishes: brown and grey

2 different materials: 1 for the heart of the product, 1 for the outer shell.
Top of the line in the composite wood market.
Beautiful shades and grain for an optimal wood imitation.

Complies with the EN 15334 norm.
Excellent slip resistance.

Very good resistance to stains, even foodstuffs.
E-modulus (elasticity) = 3,8 GPa.



NEKKO BROWN	QTY/UNIT
LENGTH 3,60 M	1294 70 pcs

NEKKO GREY	QTY/UNIT
LENGTH 3,60 M	1295 70 pcs

COMPATIBILITY

REF	DESCRIPTION
1186	Flat Rail - 150
1190	Top Rail - 150
1192	PR24 - 150
1193	PR39 - 150
1196	PR56 - 150

WEATHERING



- **Maximum spacing for private use 45 cm**
- Subject to availability
- Photos are non-contractual
- Public sector: please contact us

Up to **15 year warranty**, according to manufacturer's conditions. More features and quality criteria available on our website www.gradconcept.com



UPM

Wood plastic composite.
Available in three finishes: *Streaked Ebony*, *Californian Oak*, and *Silver Teak*

Easy to maintain and keep clean: no need to sand, oil or paint.
Safe surface: no splinters, good slip resistance, even when wet.
Durable solution: made from recycled materials, non-toxic and PVC-free.

Very good resistance to scratches and stains, even foodstuffs.



UPM STREAKED EBONY

LENGTH 4 M	2064	QTY/UNIT
		49 pcs

UPM CALIFORNIAN OAK

LENGTH 4 M	2065	QTY/UNIT
		49 pcs

UPM SILVER TEAK

LENGTH 4 M	2066	QTY/UNIT
		49 pcs

COMPATIBILITY

REF	DESCRIPTION
2031	Flat Rail - 145
2032	Top Rail - 145
2033	PR24 - 145
2034	PR39 - 145
2035	PR56 - 145

- Maximum spacing for private use 40 cm
- Subject to availability
- Photos are non-contractual
- Public sector: please contact us

Up to **25 year warranty**, according to manufacturer's conditions. More features and quality criteria available on our website www.gradconcept.com

STREAKED EBONY

CALIFORNIAN OAK

SILVER TEAK

© UPM

© UPM

© UPM

© UPM



DEX

Ceramic stoneware tile glued to an extruded PVC backing with a metal frame.

Thermoplastic profile.

Thermally cured adhesive.

Available in two finishes: Wal and Hazel
Metal reinforcement and support with grooves to fit the Grad® rail system and clips.

Wooden aesthetic with all the advantages of ceramic stoneware.
Other colors available upon request.



© Artesimia



© DEX



© Ledoux Jardin



© DEX



DEX WAL		QTY/UNIT
LENGTH 1,20 M	1871	165 pcs

DEX HAZEL		QTY/UNIT
LENGTH 1,20 M	1872	165 pcs

COMPATIBILITY	
REF	DESCRIPTION
1860	Flat Rail - 155,5
1971	Top Rail - 155,5
1970	PR24 - 155,5
1861	PR39 - 155,5
1972	PR56 - 155,5

- Maximum spacing for private use 40 cm
- Subject to availability
- Photos are non-contractual
- Public sector: please contact us

Up to **2 year warranty**, according to manufacturer's conditions. More features and quality criteria available on our website www.gradconcept.com

DEX WAL

DEX HAZEL



→ 04

CLADDING SYSTEM

Grad® System for Cladding
 Rails & Accessories
 Cladding Boards

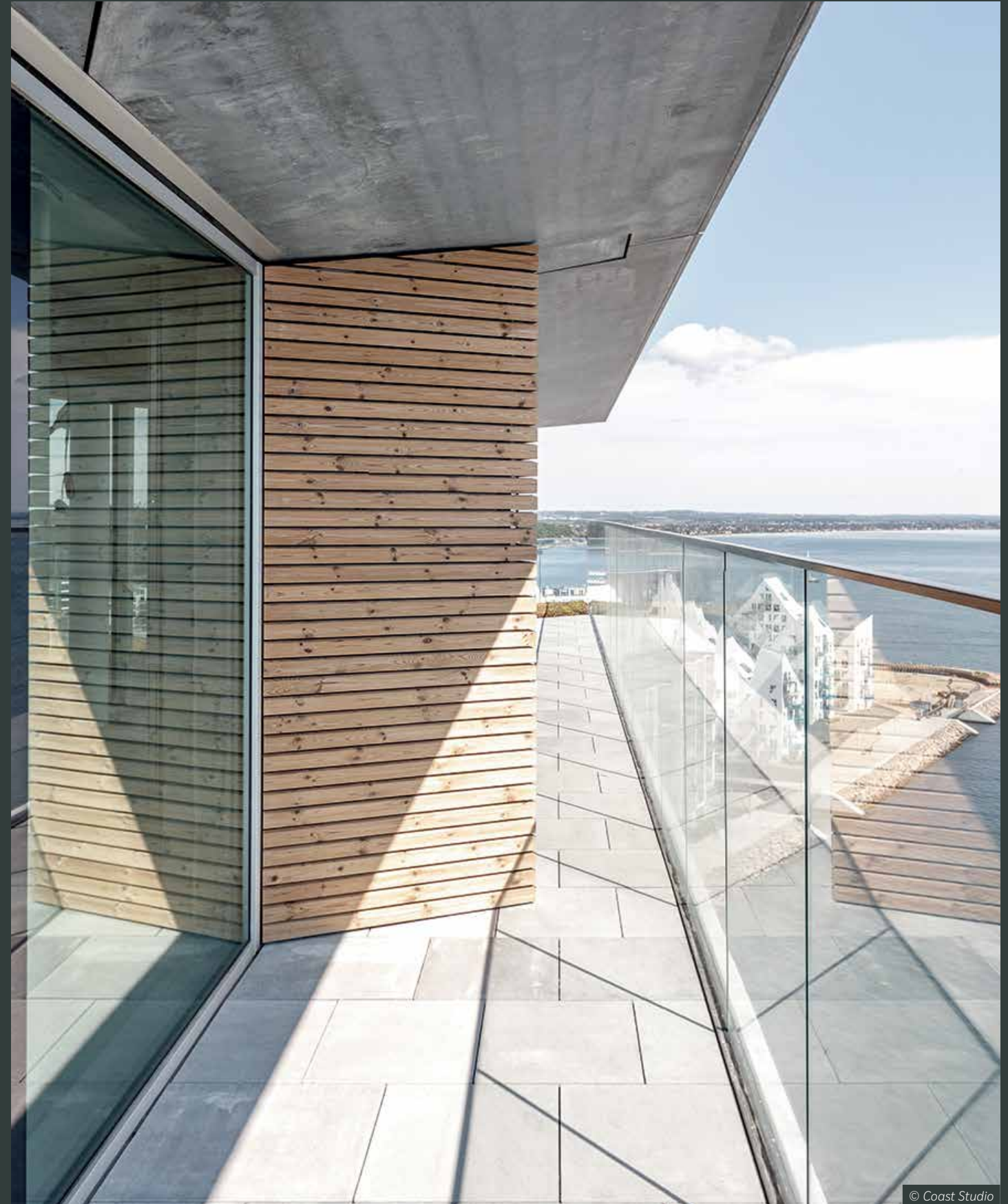

CLADDING CONFIGURATIONS

CLADDING FOR ANY TASTE

The aluminium rail, pre-fitted in our factory with polyoxymethylene (POM) clips, provides an optimal invisible fastening system for facade cladding installations. The system, which has been tested worldwide, has been recognized by

the FCBA as meeting the regulatory requirements for tear-off and durability. Thanks to the different types of rails, all configurations are possible, both in terms of cladding and finishes.

HORIZONTAL - SILVA

VERTICAL - ANTA

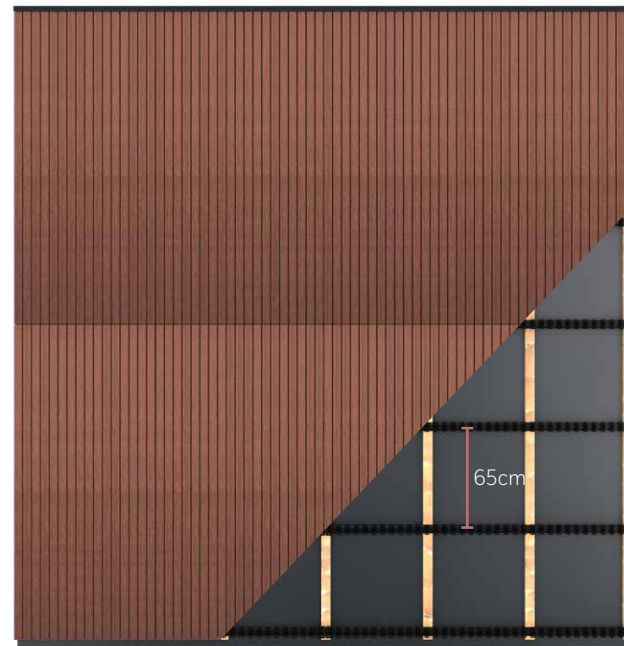
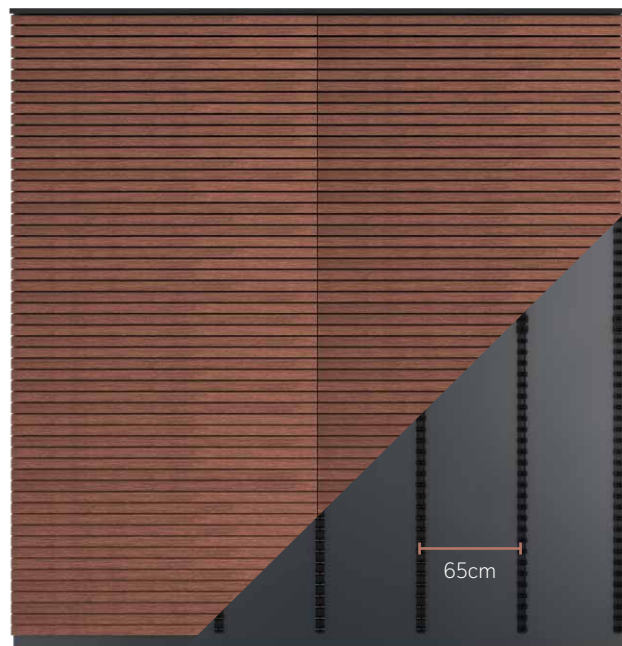

The Silva S line designates narrow boards that we recommend be installed horizontally. These profiles are manufactured at an angle to facilitate the flow of water. Several species and widths are available.

The Anta S line designates narrow boards with a recommended vertical installation. These profiles are planed with straight edges. Several species and widths are available.

Custom Projects

Thanks to the prepositioning of the clips in our factory, the Grad® system allows you to propose various spacings between the wood profiles.

You can obtain hundreds of possible combinations to personalize your facade.

In addition to the customization offered by the variability of the board spacing, many other profiles and wood finishes are compatible with the Grad® system. This document presents only the current offer.

To consult the other profiles available, please contact our sales department.



Finishes

The greying of wood is a natural phenomenon. This grey patina depends on the exposure of the wood to weather and UV radiation. It is therefore possible to see a slight difference between two parts of your cladding. However, over time, your cladding will have a uniform appearance.

The Vivid Silvered Light Grey finish has been developed to anticipate this greying of the wood and to offer, from the moment of installation, a homogeneous appearance to your cladding. Over time and without color maintenance, the natural grey of the wood will gradually take the place of the finish without any tone discontinuity.



Variable Geometry

The Varibo range includes the three Moso X-Treme profiles, which are recommended to be installed vertically, as these profiles are planed with straight edges.

Thanks to the dedicated rail that enables you to combine different widths according to the Varibo rhythm, it is possible to easily offer a unique design to the facade.

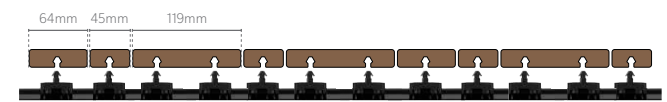

3D Cladding

Thanks to the Anta S Thermo-Pine line, it is also possible to vary the thickness of the boards. Combining the two board styles adds dimension and character to the facade by creating a 3D relief.

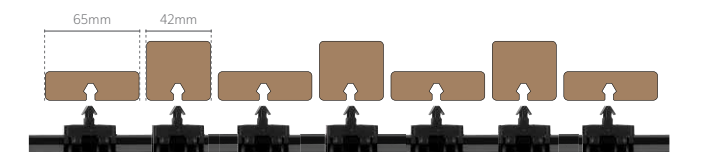

EXAMPLES OF POSSIBLE CONFIGURATIONS

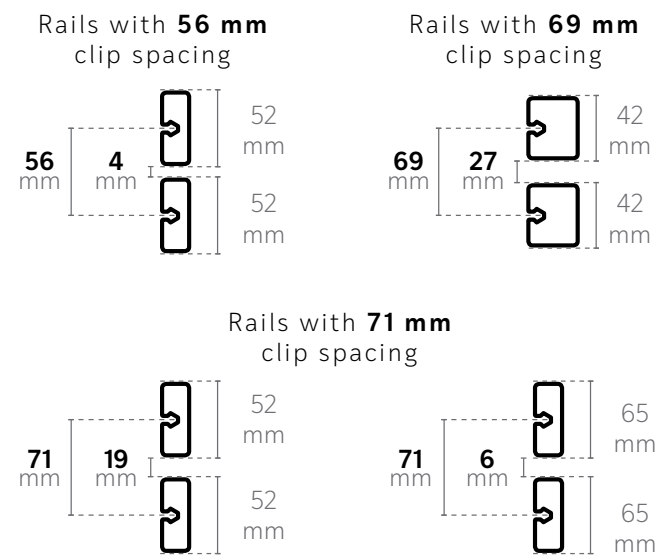
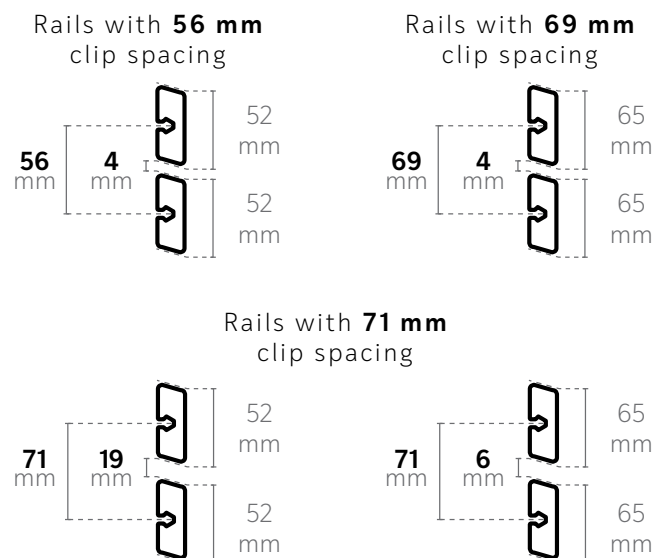

RAILS + ACCESSORIES

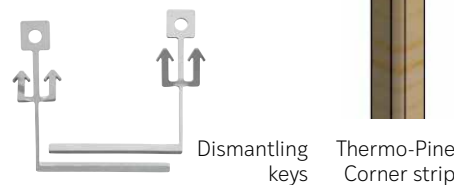
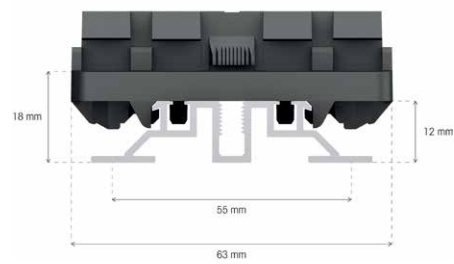
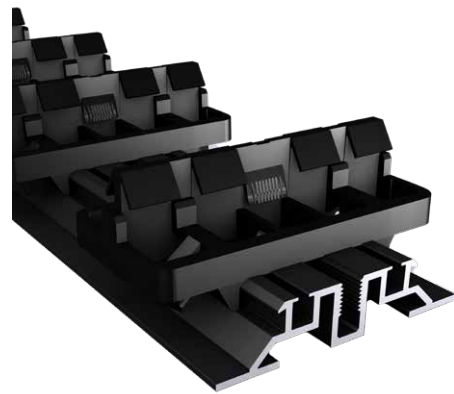

FLAT RAIL

REF	DESCRIPTION	QTY/PALLET	AVERAGE QUANTITY PER M ²
1185	FLAT RAIL - 124 mm clip spacing 32 clips for 16 boards of 120 mm 12 x 55 x 1984 mm.	216 pcs	0,85 pc
1187	FLAT RAIL - 71 mm clip spacing 28 clips for 28 boards 12 x 55 x 1988 mm.	216 pcs	0,85 pc
1188	FLAT RAIL - 56 mm clip spacing 35 clips for 35 boards 12 x 55 x 1960 mm.	216 pcs	0,85 pc
1792	FLAT RAIL - 70 mm clip spacing 28 clips for 28 boards 12 x 55 x 1960 mm.	216 pcs	0,85 pc
1799	FLAT RAIL - 51 mm clip spacing 39 clips for 39 boards 12 x 55 x 1989 mm.	216 pcs	0,85 pc
1822	FLAT RAIL - 69 mm clip spacing 29 clips for 29 boards 12 x 55 x 2001 mm.	216 pcs	0,85 pc
2480	FLAT RAIL - VARIBO 32 clips for 25 boards 12 x 55 x 1968 mm.	216 pcs	0,85 pc
2191	FLAT RAIL - 46 mm clip spacing 43 clips for 43 boards 12 x 55 x 1978 mm.	216 pcs	0,85 pc
2632	FLAT RAIL - 58,5 mm clip spacing 34 clips for 34 boards 12 x 55 x 1989 mm.	216 pcs	0,85 pc

ACCESSORIES

REF	DESCRIPTION	SALES UNIT	QTY/UNIT
2179	Glue - 310 ml cartridge For clips and wooden boards for vertical installation	1 cartridge	n/a
1488	TOP LINK S Joining piece	Bag of 20 pcs	10 bags
1489	TOP LINK L Joining piece	Bag of 20 pcs	10 bags
1486	Grad® Cushion Clip With screws	Bag of 20 pcs	25 bags
1483	Removable Grad® Clip	Bag of 50 pcs	20 bags
1485	Grad® Half Clip	Bag of 50 pcs	20 bags
968	Dismantling Keys - 120 To remove 120 mm boards or smaller	1 pair	6 pairs
1784	Dismantling Keys - 155 To remove 150 mm boards	1 pair	10 pairs
2589	Thermo-Pine Corner Strip 3.8 x 3.8 x 450 cm	1 pc	200 pcs
2611	Touch-Up Paint - Vivid Light Grey for Thermo-Pine Silvered boards - 1L	1 pc	n/a

WOODEN CLADDING

OUR PROFILES

	FINISH	REF	DESCRIPTION	POSSIBLE CLIP SPACING (MM)	BOARD SPACING (MM)		
THERMO-PINE	THERMORY LEAVE A LASTING IMPACT	2466	THP 2.0 x 6.5 x 300 cm ANTA S	69/70/71	4/5/6		
		2467	THP 2.0 x 6.5 x 360 cm ANTA S				
		2468	THP 2.0 x 6.5 x 390 cm ANTA S				
		2469	THP 2.0 x 6.5 x 420 cm ANTA S				
		2462	THP 2.0 x 6.5 x 300 cm SILVA S				
		2463	THP 2.0 x 6.5 x 360 cm SILVA S				
		2464	THP 2.0 x 6.5 x 390 cm SILVA S				
		2465	THP 2.0 x 6.5 x 420 cm SILVA S				
		2627	THP 4.2 x 4.2 x 300 cm ANTA S			46/51/56/69	4/5/9/14
		2628	THP 4.2 x 4.2 x 360 cm ANTA S				
2629	THP 4.2 x 4.2 x 390 cm ANTA S						
2630	THP 4.2 x 4.2 x 420 cm ANTA S						
SILVERED THERMO-PINE	THERMORY LEAVE A LASTING IMPACT	2577	THP 2.0 x 6.5 x 300 cm ANTA S GREY	69/70/71	4/5/6		
		2578	THP 2.0 x 6.5 x 360 cm ANTA S GREY				
		2579	THP 2.0 x 6.5 x 390 cm ANTA S GREY				
		2580	THP 2.0 x 6.5 x 420 cm ANTA S GREY				
		2581	THP 2.0 x 6.5 x 300 cm SILVA S GREY				
		2582	THP 2.0 x 6.5 x 360 cm SILVA S GREY				
		2583	THP 2.0 x 6.5 x 390 cm SILVA S GREY				
		2584	THP 2.0 x 6.5 x 420 cm SILVA S GREY				
THERMO-ASH	THERMORY LEAVE A LASTING IMPACT	1387	THF 2.0 x 5.2 x 180 cm ANTA S	56/69/70/71	4/17/18/19		
		1383	THF 2.0 x 5.2 x 210 cm ANTA S				
		1384	THF 2.0 x 5.2 x 240 cm ANTA S				
		1385	THF 2.0 x 5.2 x 270 cm ANTA S				
		1388	THF 2.0 x 5.2 x 300 cm ANTA S				
		1435	THF 2.0 x 5.2 x 150 cm SILVA S				
		1436	THF 2.0 x 5.2 x 180 cm SILVA S				
		1432	THF 2.0 x 5.2 x 210 cm SILVA S				
		1433	THF 2.0 x 5.2 x 240 cm SILVA S				
		1434	THF 2.0 x 5.2 x 270 cm SILVA S				
1437	THF 2.0 x 5.2 x 300 cm SILVA S						
MOSO	mo	2405	Moso X-Treme® 2.0 x 4.5 x 185 cm VARIBO	51/56/69/70/71	6/11/24/25/26		
		2406	Moso X-Treme® 2.0 x 6.4 x 185 cm VARIBO	69/70/71	5/6/7		
		2407	Moso X-Treme® 2.0 x 11.9 x 185 cm VARIBO	124	4		

CUSTOM ORDER

	FINISH	DESCRIPTION	POSSIBLE CLIP SPACING (MM)	BOARD SPACING (MM)
KEBONY	300	Kebony 2.0 x 5.2 x 150-420 cm ANTA S	56/69/70/71	4/17/18/19
		Kebony 2.0 x 5.2 x 150-420 cm SILVA S		
ACCOYA	accoya	Accoya 2.0 x 5.2 x 150-420 cm ANTA S NATURAL	56/69/70/71	4/17/18/19
		Accoya 2.0 x 5.2 x 150-420 cm SILVA S NATURAL		
		Accoya 2.0 x 5.2 x 150-420 cm ANTA S GREY		
		Accoya 2.0 x 5.2 x 150-420 cm SILVA S GREY		



→ 05

FEATURED PROJECTS

Grad® Creations
Get inspired!



MAIDLA NATURE RESORT

Estonia

Project: Cladding

Cladding boards: Thermory® Thermo-Ash

Architect: Mari Hunt, b210 architects

Photographer: Elvo Jackobson

→ Located in the middle of the Estonian wilderness, the goal of the Maidla resort is to offer a complex of unique and luxurious accommodations; an experience of total immersion in the heart of the forest.

↓ Built in 2020 and designed by architect Mari Hunt, the construction of this building is quite unique. On the border between forest and peat bog, the structure had to be constructed on stilts due to the instability of the soil and the risk of spring flooding from the nearby river. With several terraces at different levels, the angular building seems to rise progressively into the heart of the forest.



↑ The clients wanted to find all the amenities of a traditional hotel in a small, modern design that blended in perfectly with the environment, without cutting down any trees. The combination of the GRAD® system and Thermo-Ash fully met their requirements. The invisible fastening system made it possible to realize a project that almost disappears into the depths of nature.



→ To complete this project, the landscaper opted for our invisible fastening system to create this rooftop deck in Kebony®.

PRIVATE ROOFTOP TERRACE + GARDEN

Frankfurt, Germany

Project: Rooftop terrace
Decking boards: Kebony®
Architect: Rieger Garten
Local distributor: Rieger Garten
Photographer: Patrick Schmetzer



→ Built in the south of Frankfurt in 2019-2020, this 250 m² private garden is located on the rooftop of a residential building. Designed to create a unique and modern new living space, this project is a true oasis in the heart of the city, a showcase of the alliance of nature and urbanism. The aesthetic aspect of this garden is made possible by the union of curved lines and the combination of the different materials chosen: steel and wood.

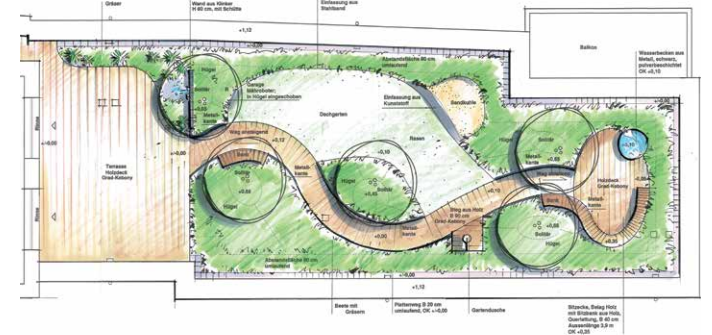

AARHUS HARBOR APARTMENTS

Aarhus, Denmark

Project: Cladding

Cladding boards: Thermory® Thermo-Pine

Architect: BIG (Bjarke Ingels Group)

Local distributor: Dolle Nordics

Photographer: R. Hjortshoj, Coast Studio

↓ The AARHUS project echoes the second largest city in Denmark Aarhus. At the crossroads of the city's bay and harbor, this building, built in 2019, culminates at different heights and offers a breathtaking view of both the city and nature. The architecture of the building is both dynamic and modern and has been designed in such a way as to preserve the existing urban atmosphere of the city of Aarhus. Shaped like two As, the 20-story residential building houses 250 apartments, all with direct ocean views.

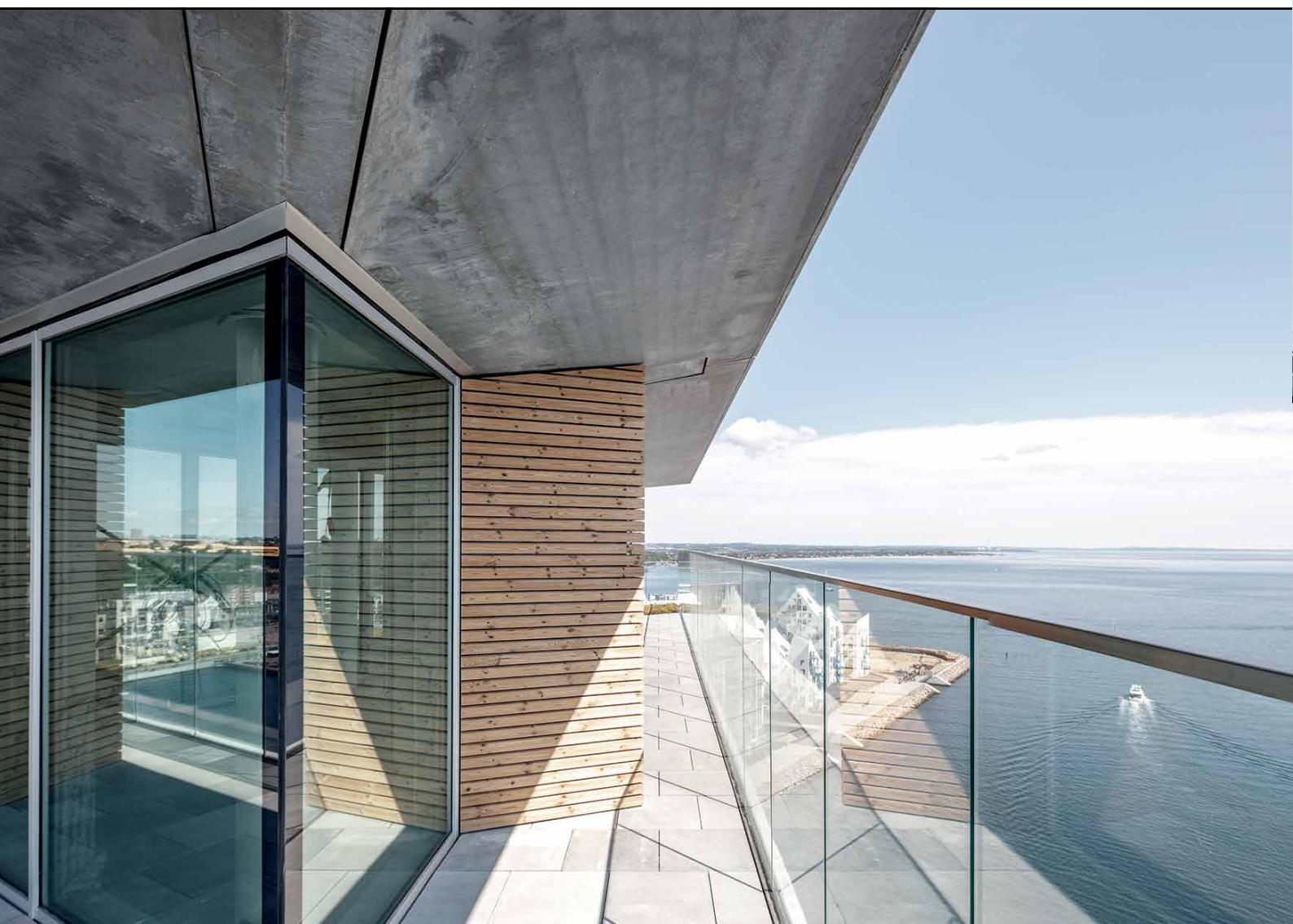

↑ To enhance this ambitious project, the Grad® system was adopted for the totality of the building's wood cladding. A solution that fully met the expectations of this project, thanks to our invisible fastening structure guaranteeing perfect drip lines. Thermo-Pine was chosen to give warmth to the angular building.



NILE STREET PRIVATE TERRACE

United Kingdom

Project: Decking

Decking boards: Thermory® Thermo-Ash

Local distributor: The Outdoor Deck Company

Photographer: The Outdoor Deck Company

↓ The very first Grad® installation in the UK, this deck was made of Thermo-Ash installed by Alfresco Floors, now The Outdoor Deck Company, in 2017. Commissioned to renovate a private rooftop terrace, the UK company approached us to address various issues of precision, speed, strength, flexibility and durability.

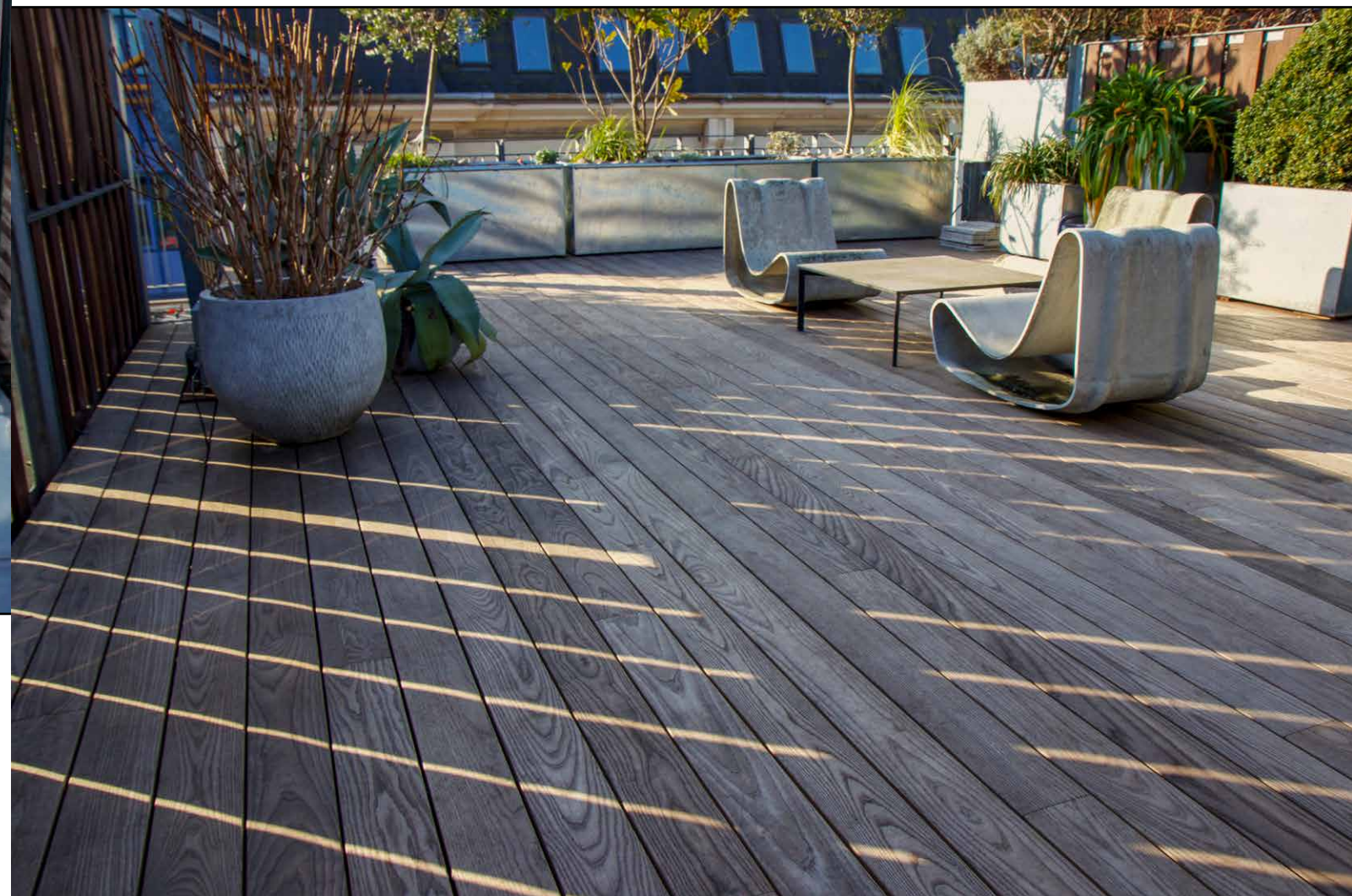

↑ Our invisible fastening system was able to meet their requirements perfectly, while ensuring optimal results and perfect board alignment.

SOLARIUM BEACH BOARDWALK

Monaco

Project: Decking

Decking boards: Moso® Bamboo X-Treme

Architect: Agence Guillermin

Partners: Aménagement et Techniques Urbaines

→ Finalized in 2022, this redevelopment project located in the heart of the Principality of Monaco is nestled on the Rainier III seawall. The objective of all the teams working on this project was to be as non-invasive as possible. To do so, the approach was to optimize the existing spaces as much as possible with a very minimal structure and by bringing in new, more modern and natural elements.

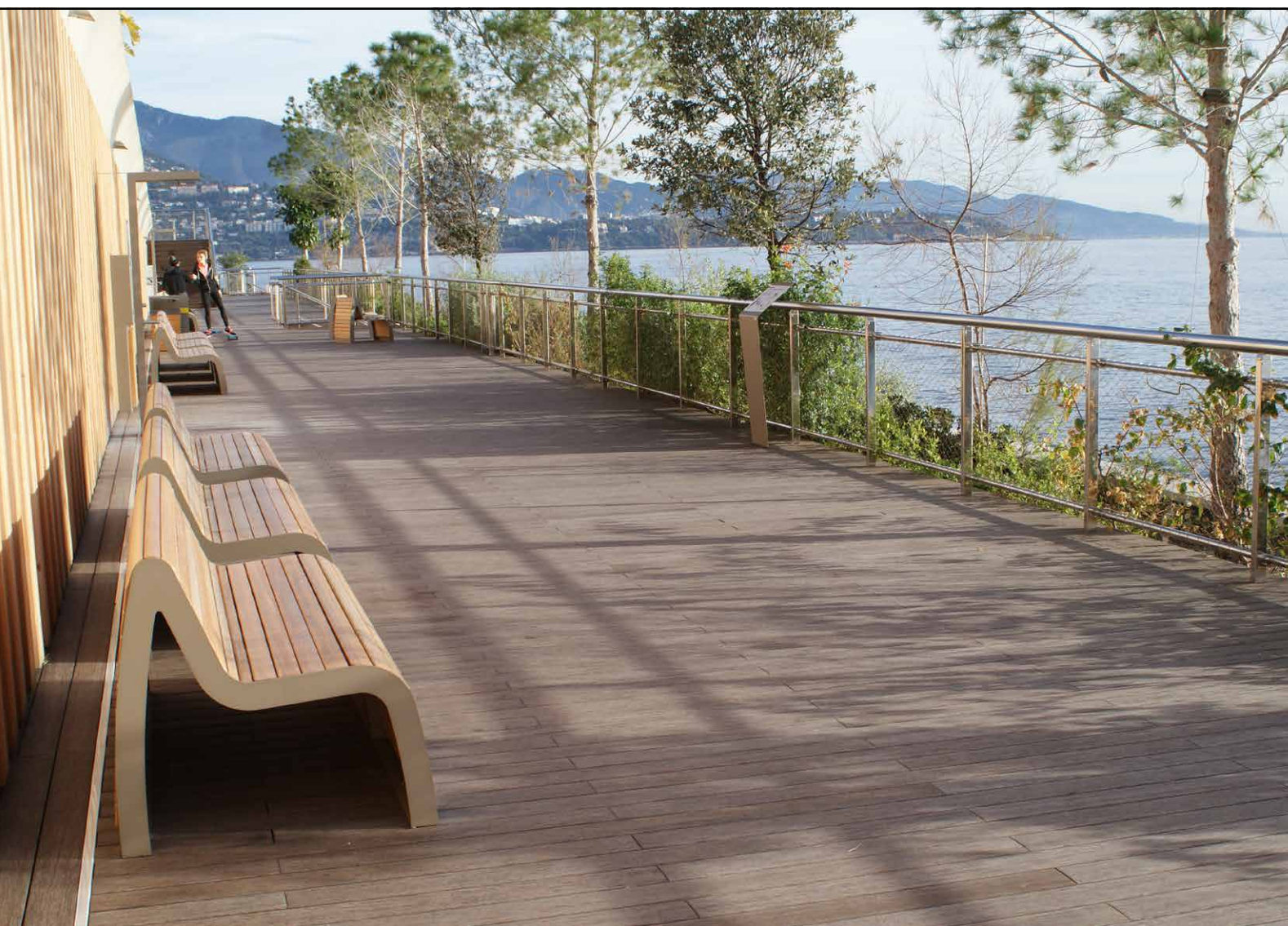
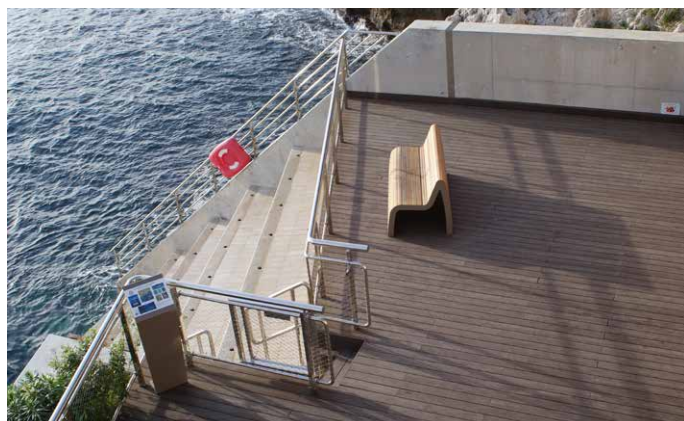

← The design project included the integration of various comfort areas such as shade, misting, wind protection, showers, and the installation of green spaces. In addition, in order to minimize glare, the choice of materials was carefully considered. This is why the teams opted for a relatively dark Moso bamboo decking to counter this phenomenon.

↑ It is therefore with this in mind that we were able to meet the various challenges of this project thanks to our invisible fastening system that disappears perfectly into the desired landscaping spaces. This guarantees a modern, natural and durable result adapted to the pre-existing surfaces.



GRAD® - BURGER & CIE

Z.I. Bois l'Abbesse
68660 LIÈPVRE - FRANCE
+33(0)3 89 58 45 45

WWW.GRADCONCEPT.COM



Artwork Grad® France - 01/2023
Photos, illustrations and documentation
are not contractual
Please don't litter
Photo credit: 1°: TIM Exclusive Gardens
Photo credit: 4°: Raad Architecten