

CATEGORÍA

LUMINARIO LED

FAMILIA

ARBOTANTE

MARCA

PHILCO/ SLP

DESCRIPCIÓN DEL PRODUCTO

- Luminario LED integrado
- Tecnología LED COB

-Cuerpo de aluminio de alta resistencia
- Terminado en color negro

-Luz directa/Indirecta

INSTALACIÓN

Sobreponer a muro

USO

Exterior

CARACTERÍSTICAS TÉCNICAS

-Potencia: 12 W
-Tensión Nominal: 90 – 265 V
-Corriente Nominal: 0,2 A
-Flujo luminoso: 720 lm
-Temperatura de color: 3 000 K
-Angulo apertura: 90°
-IP54
-Vida útil: 25 000 h
-Certificado: NOM-003-SCFI-VIGENTE

PRODUCTO



MEDIDAS

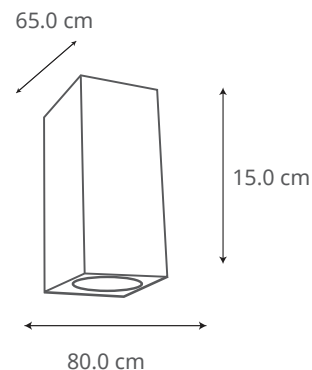

CURVA FOTOMÉTRICA

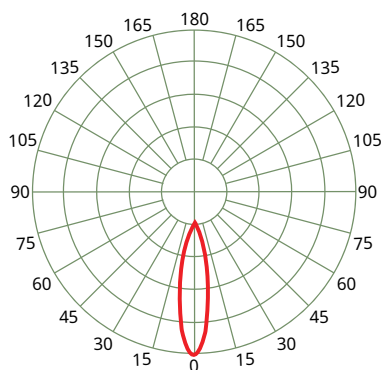

CONO DE DISTRIBUCIÓN

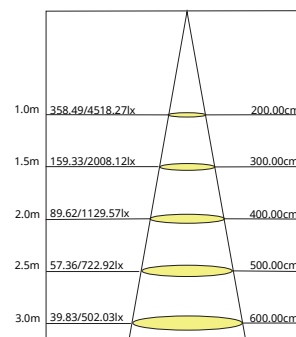

GARANTÍA

-1 años de garantía por defecto de fabricación en condiciones normales de operación

NOTAS

- Con un uso de 24 h al día la vida útil del producto reduce a 8 000 h.

APLICACIONES



Residenciales



Oficinas



Centro Comerciales



Restaurantes



Hoteles



Escuelas



Almacenes



Fábricas



Vialidad



Estacionamientos



Jardines



Joyerías



Perímetros



Campamentos



Canchas



Agropecuaria