

DRAFT COPY

DO NOT SCALE. IF IN DOUBT ASK!

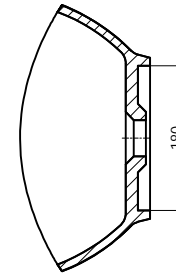

SECTION B-B

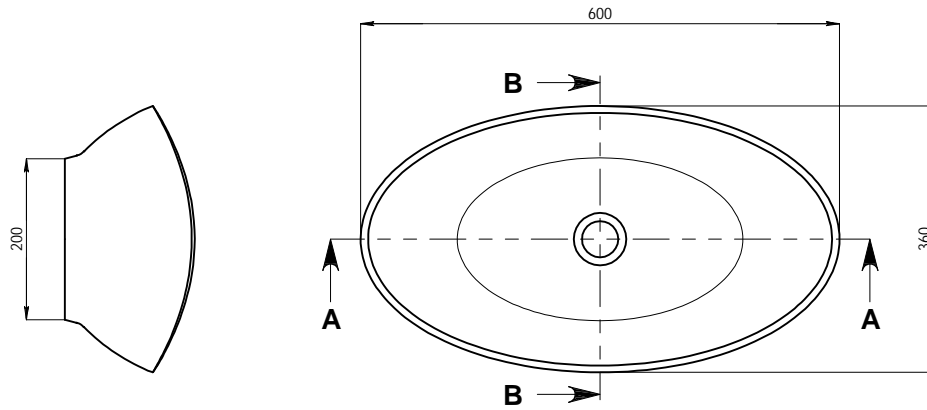
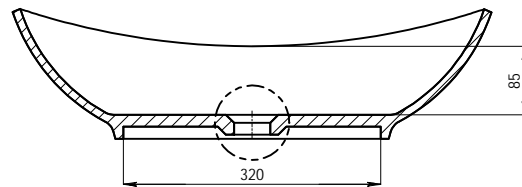
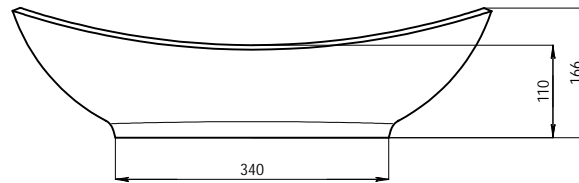
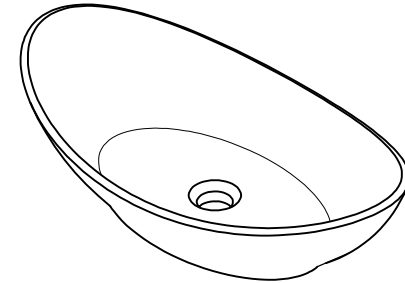

SECTION A-A

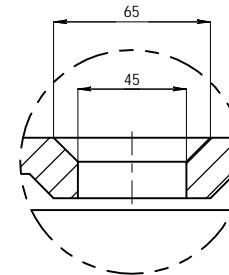

DETAIL D
SCALE 1:3

COLOUR
QTY
APPROVED BY:
NAME & SIGNATURE
DATE APPROVED:

COPYRIGHT © APPLIES. DUPLICATION OF THIS DRAWING OR ANY SPECIFIC DESIGN FEATURES IS NOT PERMITTED WITHOUT WRITTEN AUTHORITY. "COMMERCIAL CONFIDENTIALITY" IS ASSUMED AND REQUIRED.

- NOTES
1. ALL INTERNAL CORNERS TO BE R5 UNLESS OTHERWISE STATED.
 2. BASINS IN AUSTRALIA COME WITH GLOSS FINISH ONLY ON SPECIAL ORDER - 8 WEEKS DELAY (SURCHARGE APPLIES). ALL BASINS DO NOT COME WITH A WASTE FITTING.

UNLESS OTHERWISE STATED ALL DIMENSIONS IN MILLIMETERS		MATERIAL: KASKADE STONE	DRAWING NUMBER Napoli-RSA18	
DRAWING LEGEND		FINISH: REFER TO ORDER	SCALE 1:1	A4
		N.W 9 kg	Product Size 600X360X166	SHEET 1 OF 1
		G.W 11.5 kg	Package size 650X420X250	REV. 1
		LINEAR / ANGULAR TOLERANCES	DRAWN KASKADE	DATE 02/03/15
		No Decimal 1 Decimal 2 Decimals	CHK'D	DATE
		±5 ±3*		

REV	DESCRIPTION	DWG	DATE	CHK'D	DATE
1	RELEASE DATE.	KASKADE	02/03/15		



KASKADE
STONE

www.kaskadebaths.de