

The Saeco logo features a stylized 'S' inside a circle, followed by the brand name 'Saeco' in a bold, sans-serif font. Below the logo is a horizontal bar with the colors of the Italian flag: green, white, and red.

Saeco

INCANTO
HD8911

PHILIPS

Saeco, a Philips brand



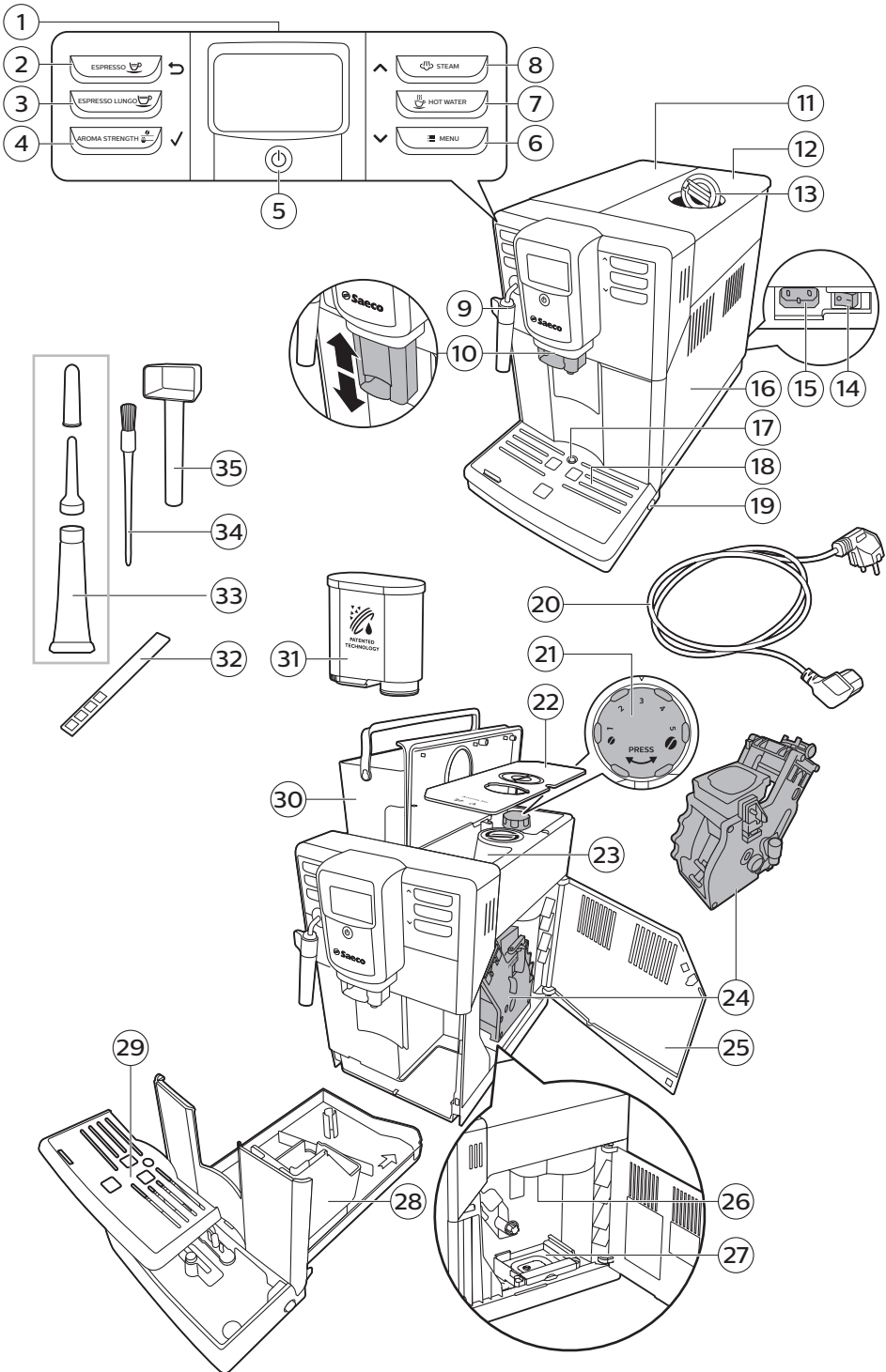

1

2

3

4

5

8

7

6

11

12

13



9

10

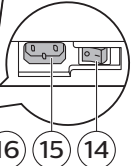

15

14

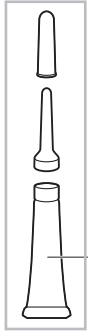

35

34

33

32

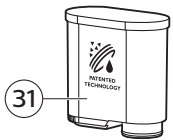

31

20

21

22

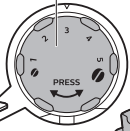

30

23

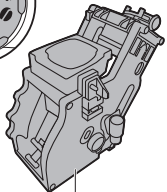

24

25

29

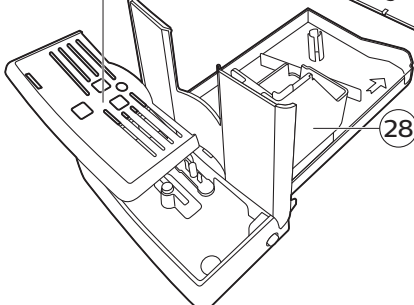

28

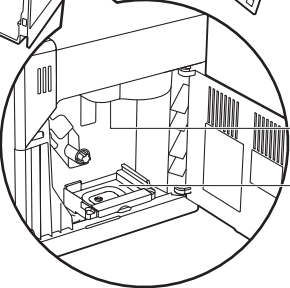

26

27

Contents

Machine overview	5
Introduction	6
First installation	7
AquaClean filter	7
Activating the AquaClean filter	7
Replacing the AquaClean filter	8
Replacing the AquaClean filter after 8 filters were used	9
Measuring the water hardness	9
Control panel and display	10
One-touch beverage buttons	10
Navigation buttons	10
MENU button	10
AROMA STRENGTH button	10
Brewing coffee	11
Brewing coffee with beans	11
Brewing coffee with pre-ground coffee	11
Frothing milk	11
Hot water	12
Beverage types and lengths	12
Beverage types	12
Beverage lengths	13
Adjusting volume and taste	13
Adjusting coffee volume	13
Adjusting coffee strength	13
Adjusting grinder settings	14
Cleaning and maintenance	14
Cleaning table	15
Cleaning the brew group	15
Cleaning the brew group under the tap	15
Cleaning the brew group with coffee oil remover tablets	16
Reinserting the brew group	16
Lubrication	17
Cleaning the classic milk frother	18
Daily cleaning of classic milk frother	18
Weekly cleaning of classic milk frother and steam wand	18
Descaling procedure	18
What to do if the descaling procedure is interrupted	20
Warning icons and error codes	20
Meaning of the warning icons	20
Meaning of the error codes	21
Troubleshooting	22

Machine overview

6 English

2	ESPRESSO button	20	Cord
3	ESPRESSO LUNGO button	21	Grind setting knob
4	AROMA STRENGTH button	22	Cover of bean hopper
5	Standby button	23	Bean hopper
6	MENU button	24	Brew group
7	HOT WATER button	25	Inside of service door with cleaning instructions
8	STEAM button	26	Coffee exit duct
9	Classic milk frother	27	Coffee residues drawer
10	Adjustable coffee dispensing spout	28	Coffee grounds container
11	Lid of water tank	29	Drip tray cover
12	Lid of bean hopper	30	Water tank
13	Lid of pre-ground coffee compartment	31	AquaClean filter
14	Main switch	32	Water hardness tester
15	Socket for cord	33	Grease tube with application tip and cap
16	Service door	34	Cleaning brush
17	'Drip tray full' indicator	35	Measuring scoop
18	Drip tray		

Introduction

Congratulations on your purchase of a Saeco full-automatic coffee machine! To fully benefit from the support that Saeco offers, please register your product at www.saeco.com/care.

To help you get the best out of your coffee machine, Saeco offers full support in 4 different ways:

- The separate quick start guide for first installation and first use.
- This user manual for more detailed information on how to use the machine, how to keep it clean, how to descale it and how to solve problems.



- This is the QR code. Scan this code to access instruction videos on how to brew the best coffees, how to clean the machine and for a list of frequently asked questions. (www.saeco.com/care)
- The separate booklet with important safety information.

First installation

For first installation, follow the instructions on the separate quick start guide.

Note: This machine has been tested with coffee. Although it has been carefully cleaned, there may be some coffee residues left. We guarantee, however, that the machine is absolutely new.

Note: You can install the AquaClean filter during the first installation procedure (see separate quick start guide). If you skip installation of the AquaClean filter at first use, you can install it later by entering the menu (see 'Activating the AquaClean filter').

AquaClean filter

The AquaClean filter is designed to reduce limescale deposits in your coffee machine and provide filtered water to preserve the aroma and flavor of each cup of coffee. If you use a series of 8 AquaClean filters as indicated in this user manual, you don't have to descale your machine for up to 5000 cups.

Note: Your machine has to be completely limescale-free before you start to use the AquaClean filter. If you did not activate the filter during first installation, you need to descale the machine before you activate the filter.

Activating the AquaClean filter

Note: Always confirm activation of the AquaClean filter in the machine menu as described below. You also need to do this after replacing the AquaClean filter. By activating the AquaClean filter in the machine menu, the machine monitors the number of filters used. When the filter has been replaced 8 times, the machine reminds you to descale it.

- 1 For instructions on how to place the AquaClean filter in the water tank, see the separate quick start guide.

Note: Shake the AquaClean filter for about 5 seconds, immerse it upside down in a jug with cold water and wait until no more air bubbles come out.



- 2 Press the MENU button, select MENU and press the OK button to confirm. Scroll to AQUACLEAN FILTER. Press the OK button to confirm.
 - The display shows the number of AquaClean filters that have been installed previously from 0 to 8 filters.

- 3 Select ON on the display, press the OK button to confirm.

- 4 The display automatically updates the number of filters used.

- Then the 'machine ready' screen appears with the AquaClean 100% icon to indicate that the filter has been installed.

- 5 Dispense 2 cups of hot water (0.5 l) to complete the activation. Discard this water.

Replacing the AquaClean filter

Note: Replace the AquaClean filter as soon as the capacity has dropped to 0% and the filter icon flashes quickly. Replace the AquaClean filter at least every 3 months, even if the machine has not yet indicated that replacement is required.

Tip: We advise you to buy a new filter when the capacity has dropped to 10% and the filter icon starts flashing slowly. This ensures that you can replace the filter when the capacity has dropped to 0%.

- 1 Take out the AquaClean filter and replace it by a new AquaClean filter (also see the separate quick start guide).
- 2 Press the MENU button, scroll to AQUACLEAN FILTER and press the OK button to confirm.



- The display asks if you want to activate a new filter.

- 3 Press the OK button to confirm.



- The display automatically updates the number of filters used.
- 4 Dispense 2 cups of hot water (0.5 l) to complete the activation. Discard this water.

Replacing the AquaClean filter after 8 filters were used

DESCALE BEFORE
ACTIVATING FILTER

- 1 When the filter icon starts flashing on the display, press the MENU button, scroll to AQUACLEAN FILTER and press the OK button to confirm.
 - The display tells you that you need to descale the machine before activating the new filter.
- 2 Press the OK button to start the descaling procedure.
 - Press the escape button several times to leave the filter menu if you do not want to descale right away.
- 3 At the end of the descaling procedure, the display asks you if you want to install the AquaClean filter.
 - Follow the steps in 'Replacing the AquaClean filter'.

Measuring the water hardness

Note: If you have installed the AquaClean filter, you do not need to set the water hardness.

To be able to adjust the machine settings to the water in your region, please measure the water hardness with the water hardness test strip supplied. The default water hardness of the machine is set to the highest level (4). If the measured water hardness is different, adjust the setting in the machine menu.

- 1 Immerse the water hardness test strip (supplied with the machine) in tap water for 1 second.
- 2 Remove the water hardness test strip and wait for 1 minute.
- 3 Check how many squares have turned red and check the water hardness in the table below.

number of red squares	value to be set	water hardness
■□□□	1	very soft water
■ ■ □ □	2	soft water
■ ■ ■ □	3	hard water
■ ■ ■ ■	4	very hard water

- 4 Press the MENU button, select menu and scroll to select water hardness. Select the preferred water hardness setting and press the OK button to confirm.

Control panel and display

This espresso machine has a self-explaining display for easy use. Read the sections below for a quick explanation of the buttons.

One-touch beverage buttons

Use the one-touch beverage buttons (ESPRESSO, ESPRESSO LUNGO, HOT WATER and STEAM) to quickly prepare one of the preset beverages.

- If you want to stop the brewing process before the machine has finished dispensing the preset coffee volume, press the OK button.
- Use the STEAM button to froth milk.
- You can adjust the volume of espresso or espresso lungo (see 'Adjusting coffee volume').

Navigation buttons

Some of the one-touch beverage buttons have a double function; use these buttons to navigate through the menu:



ESPRESSO button = **Escape button**: press this button to return to the main menu.



STEAM button = **Up button**: press this button to scroll up through the display menu.



AROMA STRENGTH button = **OK button**: press this button to select, confirm or stop a function.



MENU button = **Down button**: press this button to scroll down through the display menu.

MENU button

Use the MENU button to change the following settings:

- Display contrast
- Coffee temperature
- Stand-by time: this is the time after which the machine goes into standby mode.
- Water hardness: to be able to adjust the machine settings to the water in your region, please measure the water hardness.
- To activate the AquaClean filter
- To start descaling

AROMA STRENGTH button

Use the AROMA STRENGTH button to adjust the coffee strength (see 'Adjusting coffee strength') or to brew pre-ground coffee (see 'Brewing coffee with pre-ground coffee').

Brewing coffee

Brewing coffee with beans

Caution: Only use espresso beans. Never put ground coffee, unroasted coffee beans or caramelized coffee beans in the bean hopper, as this may cause damage to the machine.

To brew coffee, follow the instructions on the separate quick start guide.

To brew two cups of espresso or espresso lungo, press the button of the desired beverage twice. The machine automatically carries out two grinding cycles in sequence.

Note: Using the cover of the bean hopper helps to keep the beans fresh.

Brewing coffee with pre-ground coffee

When you brew coffee with pre-ground coffee, use the measuring scoop supplied to put the correct dose in the pre-ground coffee compartment. Do not add too much pre-ground coffee to avoid the coffee grounds drawer from getting clogged.

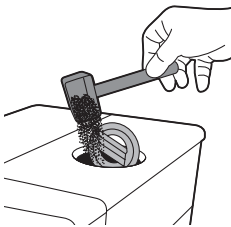

- 1 Open the lid of the pre-ground coffee compartment.
- 2 Pour **one** measuring scoop of pre-ground coffee into the pre-ground coffee compartment and close the lid.

Caution: Do not put any other substance than pre-ground coffee in the pre-ground coffee compartment, as this may damage the machine.

- 3 Place a cup under the coffee dispensing spout.
- 4 Press the AROMA STRENGTH button and select the pre-ground coffee brewing function.
- 5 Press the ESPRESSO button.

The machine automatically starts brewing the selected beverage.

Note: With pre-ground coffee you can only brew one coffee at a time.

Frothing milk

Warning: Danger of scalding! Dispensing may be preceded by small jets of hot water. Use the appropriate protective handle only.

Note: Use cold milk (at a temperature of approximately 5°C/41°F) with a protein content of at least 3% to ensure an optimal frothing result. You can use whole milk or semi-skimmed milk. It is also possible to use skimmed milk, soy milk and lactose-free milk.

Note: We advise you to rinse the water circuit before use. Press the STEAM button to dispense steam for a few seconds.

- 1 Fill 1/3 of a jug with cold milk.
- 2 Insert the classic milk frother into the milk. Press the STEAM button.



- 3 Froth the milk by gently swirling the jug and moving it up and down.
- 4 Press the OK button to stop frothing.

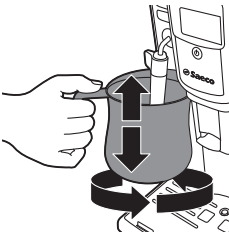

Hot water

Warning: Danger of scalding! Dispensing may be preceded by small jets of hot water. Use the appropriate protective handle only.

- 1 Place a jug under the classic milk frother.
- 2 Press the HOT WATER button. The machine starts dispensing hot water.
- 3 To stop dispensing hot water, press the OK button.

Beverage types and lengths

Beverage types

Beverage name	Description	How to select
Espresso	Coffee with thick crema served in a small cup	One-touch beverage button on control panel
Espresso lungo	A longer espresso with thick crema served in a medium-sized cup	One-touch beverage button on control panel
Milk froth	Hot milk with foam	One-touch beverage button on control panel
Hot water		One-touch beverage button on control panel

Beverage lengths

Beverage name	Standard length	Length range
Espresso	40 ml	20 - 230 ml
Espresso lungo	80 ml	20 - 230 ml
Steam	xx ml	xx - xxx ml
Hot water	300 ml	50 - 450 ml

Adjusting volume and taste

Adjusting coffee volume

You can adjust the volume of the beverage brewed according to your taste and to the size of the cups.

- 1** To adjust the espresso volume, press and hold the ESPRESSO button until the display shows the MEMO icon.
 - The machine enters the programming phase and starts to brew the selected beverage.
- 2** Press the OK button when the cup contains the desired amount of espresso.
 - The tick on the display shows that the button is programmed: every time it is pressed, the machine brews the set espresso volume.

Note: To set the volume of espresso lungo, follow the same procedure: press and hold the button of the beverage until the MEMO icons appears on the display and press the OK button when the cup contains the desired amount.

Adjusting coffee strength

To change the coffee strength, press the AROMA STRENGTH button. Each time you press the AROMA STRENGTH button, the aroma strength changes by one degree. The display shows the chosen strength, which is only saved if you brew a coffee.

14 English

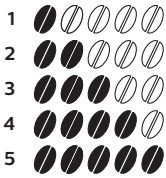

- 1 Very mild
- 2 Mild
- 3 Regular
- 4 Strong
- 5 Very strong

Note: The machine automatically dispenses the correct coffee volume for each coffee strength.

Note: You can also use the AROMA STRENGTH button to brew coffee with pre-ground coffee.

Note: After adjusting the coffee strength, the display shows the main menu again and saves the chosen aroma strength when you brew a coffee.

Adjusting grinder settings

You can adjust the grinder settings by using the grind setting knob inside the bean container.

Note: You can only adjust the grind settings when the machine is grinding coffee beans.

Caution: Do not turn the grind setting knob more than one notch at a time to prevent damage to the grinder.

- 1 Place a cup under the coffee dispensing spout.
 - 2 Open the lid of the bean hopper.
 - 3 Press the ESPRESSO button.
 - 4 When the grinder starts grinding, press down the grind setting knob and turn it to the left or right.
- There are 5 different grind settings you can choose from. The lower the setting, the stronger the coffee.

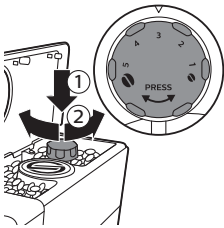

Cleaning and maintenance

Note: Consult the table below for when and how to clean all detachable parts of the machine. For more detailed information on how to clean the brew group and how to descale the machine, read the corresponding chapters below or go to the dedicated website www.saeco.com/care.

Cleaning table

Part description	When to clean	How to clean
Brew group	Weekly	Remove the brew group and clean it under the tap (see 'Cleaning the brew group under the tap').
	Depending on the type of usage	Lubricate the brew group (see 'Lubrication').
	Monthly	Clean the brew group with the coffee oil remover tablets.
Classic milk frother	After every use	Rinse with fresh water (see 'Daily cleaning of classic milk frother').
	Weekly	Disassemble the classic milk frother and clean all parts under the tap (see 'Weekly cleaning of classic milk frother and steam wand').
Drip tray	As soon as the red 'drip tray full' indicator pops up through the drip tray.	Empty the drip tray and clean it under the tap.
Coffee grounds container	When it suits you	Empty the coffee grounds container and clean it under the tap. Make sure the machine is switched on while you empty and clean the coffee grounds container.
Water tank	When it suits you	Clean it under the tap.
Pre-ground coffee compartment/coffee exit duct	Weekly	Clean the top part with a spoon handle as shown below.

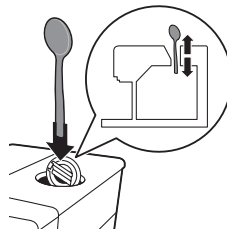

Cleaning the brew group

Note: Scan the QR code or go to www.saeco.com/care for detailed instructions on how to disassemble and clean the brew group.

Caution: Do not clean the brew group in the dishwasher and do not use washing-up liquid or a cleaning agent to clean it. This may cause the brew group to malfunction and may have a negative effect on the coffee taste.

Cleaning the brew group under the tap

- 1 Switch off the machine and unplug it.

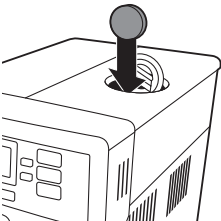
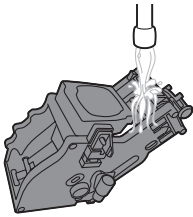
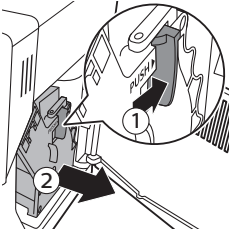

- 2 Remove the drip tray with the coffee grounds container.
- 3 Open the service door.
- 4 Press the PUSH button (1) and pull at the grip of the brew group to remove it from the machine (2).

- 5 Rinse the brew group thoroughly with lukewarm water. Clean the upper filter carefully.
- 6 Let the brew group air-dry.

Note: Do not dry the brew group with a cloth to prevent fibers from collecting inside the brew group.

Cleaning the brew group with coffee oil remover tablets

Caution: Only use coffee oil remover tablets for cleaning. They do not have a descaling function.

- 1 Place a container under the coffee dispensing spout.
- 2 Press the AROMA STRENGTH button and select pre-ground coffee.
- 3 Put a coffee oil remover tablet in the pre-ground coffee compartment.
- 4 Press the ESPRESSO LUNGO button. The machine dispenses water from the coffee dispensing spout.
- 5 When the progress bar has reached the middle, set the main switch on the back of the machine to OFF.
- 6 Let the coffee oil remover solution act for approximately 15 minutes.
- 7 Set the main switch to ON. Press the standby button.
- 8 Wait until the machine performs an automatic rinsing cycle.
- 9 Perform the 'Weekly cleaning of the brew group' procedure.
- 10 Remove the drip tray with the coffee grounds container. Empty the drip tray and the coffee grounds container and place them back in the machine.
- 11 Press the AROMA STRENGTH button and select pre-ground coffee.
- 12 Press the ESPRESSO LUNGO button. The machine dispenses water from the coffee dispensing spout.
- 13 Repeat steps 12 and 13 twice. Discard the dispensed water.

Reinserting the brew group

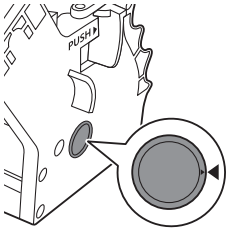

- 1 Before you slide the brew group back into the machine, make sure the two yellow reference signs on the side match. If they do not match, perform the following step:

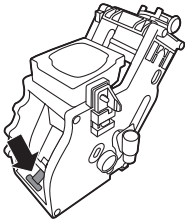

- Make sure the lever is in contact with the base of the brew group.
- 2 Make sure that the yellow locking hook of the brew group is in the correct position.

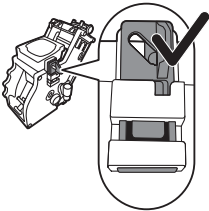

- To position the hook correctly, push it upwards until it is in uppermost position.

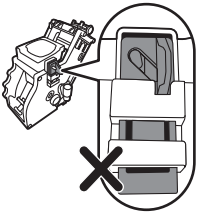

- The hook is not positioned correctly if it is still in bottommost position.
- 3 Slide the brew group back into the machine along the guiding rails on the sides until it locks into position with a click.

Caution: Do not press the PUSH button.

- 4 Close the service door.

Lubrication

For optimal performance of the machine, you have to lubricate the brew group. See table below for the lubrication frequency. For support visit our website: www.saeco.com/care.

Usage frequency	Nr of beverages brewed daily	Lubrication frequency
Low	1-5	Every 4 months
Normal	6-10	Every 2 months
Heavy	>10	Every month

- 1 Switch off the appliance and unplug it.
- 2 Remove the brew group and rinse it under a lukewarm tap (see 'Cleaning the brew group under the tap').

18 English

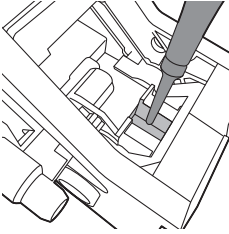

- 3 Apply a thin layer of grease around the shaft in the bottom of the brew group.

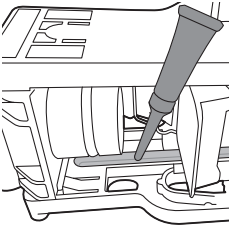

- 4 Apply a thin layer of grease to the rails on both sides (see figure).
- 5 Reinsert the brew group (see 'Reinserting the brew group').

You can use the grease tube multiple times.

Cleaning the classic milk frother

Daily cleaning of classic milk frother

Remove the external part of the classic milk frother and rinse it with fresh water.

Weekly cleaning of classic milk frother and steam wand

- 1 Remove the external part of the classic milk frother and rinse it with fresh water.

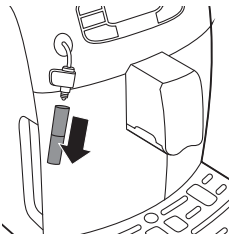

- 2 Remove the upper part of the classic milk frother from the steam wand and rinse it with fresh water.

- 3 Clean the steam wand with a wet cloth.

- 4 Reassemble all the classic milk frother parts.

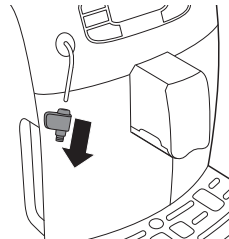

Descaling procedure

When the display shows START CALC CLEAN, you need to descale the machine. If you do not descale the machine when this message appears on

the display, the machine will eventually stop working properly. In that case, repairs are not covered by the warranty.

Only use Saeco descaling solution to descale the machine. Saeco descaling solution is designed to ensure optimal performance of the machine. The use of other products may damage the machine and leave residues in the water. You can buy Saeco descaling solution in the online shop at www.saeco.com/care.

The descaling procedure lasts 30 minutes and consists of a descaling cycle and a rinsing cycle. You can pause the descaling or rinsing cycle by pressing the escape button. To continue the descaling or rinsing cycle, press the OK button.

Note: Do not remove the brew group during the descaling procedure.

Warning: Do not drink the descaling solution or the water dispensed during the descaling procedure.

- 1 Remove the drip tray and the coffee grounds container, empty and clean them and put them back into place.
- 2 Remove the external part of the classic milk frother.
- 3 Place a large container (1.5 l) under the coffee dispensing spout and the classic milk frother.
- 4 When the display shows START CALC CLEAN, press the OK button to start the descaling procedure. Remove the hot water dispensing spout if present.



- The display reminds you that you have to remove the AquaClean filter.



Note: You can press the escape button to skip descaling. If you want to start the descaling procedure later, press the MENU button, select MENU and scroll to select DESCALING. Press OK to confirm.

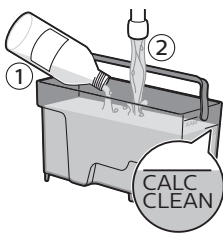

- 5 Pour the descaling solution into the water tank. Fill the water tank with fresh water up to the CALC CLEAN level indication. Place the water tank back into the machine. Press the OK button to confirm.
 - The first phase of the descaling procedure starts. The machine starts dispensing the descaling solution at intervals.
 - The display shows the descaling icon, the phase indication and the duration. This first phase takes 20 minutes.
- 6 Let the machine dispense the descaling solution until the water tank is empty.
- 7 Remove the water tank and rinse it.

- 8 Fill the water tank with fresh water up to the CALC CLEAN level indication. Place the water tank back in the machine and press OK.
- 9 Remove and empty the container and place it back under the coffee dispensing spout. Press OK to confirm.
- 10 The second phase of the descaling procedure starts, which is the rinsing cycle. This phase takes 3 minutes. The display shows the rinsing icon and the duration of the phase.

Note: If the water tank is not filled up to the CALC CLEAN level, the machine may require another rinsing cycle.

- 11 Wait until the machine stops dispensing water. The descaling procedure is finished when the tick appears on the display.
- 12 Press the OK button to exit the descaling procedure. The machine starts heating up and performs the automatic rinsing cycle.
- 13 Remove and empty the container.
- 14 Clean the classic milk frother after descaling (see 'Weekly cleaning of classic milk frother and steam wand').
- 15 Clean the brew group (see 'Cleaning the brew group').
- 16 Install a new AquaClean filter in the water tank.

Tip: Using the AquaClean filter reduces the need for descaling!

What to do if the descaling procedure is interrupted

Once the descaling procedure has started, you must let the machine perform the entire procedure until the very end without switching off the machine. If the machine gets stuck during descaling, you can exit the descaling procedure by pressing the standby button. If this occurs, or in case of a power failure or accidental disconnection of the cord, do the following:

- 1 Empty and rinse the water tank thoroughly.
- 2 Fill the water tank up to the CALC CLEAN level indication and switch the machine back on. The machine will heat up and perform an automatic rinsing cycle.
- 3 Before brewing any beverages, perform a manual rinsing cycle.

Note: If the descaling procedure was not completed, the machine will require another descaling procedure as soon as possible.

Warning icons and error codes

Meaning of the warning icons

Warning icons are displayed in red. Below you find a list of the warning icons that may appear on the display and their meaning.



Fill the water tank with fresh water to the MAX level indication.



Close the service door.



The bean hopper is empty. Put new coffee beans in the bean hopper.



Remove the coffee grounds container and empty it.



The brew group is not in the machine or it is not inserted properly. Insert the brew group.



If the display shows an error code, check section 'Meaning of the error codes' to see what the code on the display means and what you can do. The machine cannot be used when this icon is on the display.



Insert the drip tray.

Meaning of the error codes

Below you find a list of the error codes that may appear on the display, their meaning and how to solve the problem. If these solutions do not help to remove the error code from the display and bring the machine back to normal working order, contact the Saeco hotline. Contact details can be found in the warranty booklet or on www.saeco.com/care.

Error code	Problem	Cause	Possible solution
01	The coffee grinder is blocked	The coffee exit duct is clogged.	Clean the coffee exit duct thoroughly with the handle of the measuring spoon or a spoon handle. Switch the appliance off and on again.
03 - 04	There is a problem with the brew group.	The brew group is dirty. The brew group is not positioned correctly.	Remove the brew group and clean it thoroughly (see 'Cleaning the brew group'). Remove the brew group and reinsert it. Make sure the two reference signs on the side match before you slide the brew group back into the machine.
05	There is a water circuit problem.	There is air in the water circuit.	Remove and place back the water tank a couple of times. Make sure you insert it into the machine properly. Check if the water tank compartment is clean. If you use an AquaClean filter: remove the AquaClean filter from the water tank and shake it to remove all air from the filter. Then place the AquaClean filter back into the water tank.

Error code	Problem	Cause	Possible solution
14	The machine is overheated.	This can have several causes.	Switch the machine off and switch it back on again after 30 minutes. Try this 2 or 3 times.

Troubleshooting

This chapter summarizes the most common problems you could encounter with the machine. If you are unable to solve the problem with the information below, visit www.saeco.com/care for a list of frequently asked questions or contact the Consumer Care Center in your country.

Problem	Cause	Solution
The machine does not switch on.	The machine is disconnected or the main switch is in the 'off' position (O).	Check if the mains cord is inserted correctly. Make sure the main switch is set to 'on' position (I).
The machine is in DEMO mode.	You pressed the standby button for more than 8 seconds.	Switch the machine off and then on again with the main switch on the back of the machine.
The drip tray fills up quickly.	This is normal. The machine uses water to rinse the internal circuit and brew group. Some water flows through the internal system directly into the drip tray.	Empty the drip tray when the 'drip tray full' indicator pops up through the drip tray cover. Place a cup under the dispensing spout to collect rinsing water.
The 'coffee grounds container full' icon remains displayed.	You emptied the coffee grounds container while the machine was switched off.	Always empty the coffee grounds container while the machine is switched on. If you empty the coffee grounds container when the machine is switched off, the coffee cycle counter is not reset. In that case, the 'empty coffee grounds container' message stays on the display even though the container is not full.
	You placed back the coffee grounds container too fast.	Do not place back the coffee grounds container until the display message prompts you to put it back.
I cannot remove the brew group.	The brew group is not in the correct position.	Close the service door. Switch the machine off and back on again. Wait for the 'machine ready' screen to appear and then remove the brew group.
	You have not removed the coffee grounds container.	Remove the coffee grounds container before you remove the brew group.

Problem	Cause	Solution
I cannot insert the brew group.	The brew group is not in the correct position.	You did not put the brew group in the correct position before placing it back. Make sure that the lever is in contact with the base of the brew group and that the hook of the brew group is in the correct position.
		Reset the machine in the following way: place the drip tray and the coffee grounds container back. Leave the brew group out. Close the service door and switch the machine on and off. Then try to reinsert the brew group.
	The machine is still in the descaling procedure.	You cannot remove the brew group when the descaling procedure is active. First complete the descaling process and then remove the brew group.
The coffee has too little crema or is watery.	The grinder is set to a too coarse setting.	Adjust the grinder to a finer setting.
	The coffee blend is not the correct one.	Change the coffee blend.
	The machine is performing its self-adjustment procedure.	Brew a few cups of coffee.
	The brew group is dirty.	Clean the brew group.
Coffee is leaking from the coffee dispensing spout.	The coffee dispensing spout is clogged.	Clean the coffee dispensing spout and its holes with a pipe cleaner.
	The coffee exit duct is clogged.	Clean the coffee exit duct.
The coffee is not hot enough.	The cups you use are cold.	Preheat the cups by rinsing them with hot water.
	The temperature is set too low. Check the menu settings.	Set the temperature to 'high' in the menu.
	You added milk.	Whether the milk you add is warm or cold, it always decreases the temperature of the coffee to some extent.
The machine grinds the coffee beans, but coffee does not come out.	The coffee exit duct is blocked.	Clean the coffee exit duct with the handle of the measuring spoon or a spoon handle. Switch the appliance off and on again.
	The grinder is set to a too fine setting.	Adjust the grinder to a coarser setting.
	The brew group is dirty.	Clean the brew group.

Problem	Cause	Solution
	The coffee dispensing spout is dirty.	Clean the coffee dispensing spout and its holes with a pipe cleaner.
The coffee comes out slowly.	The grinder is set to a too fine setting.	Use a different coffee blend or adjust the grinder.
	The brew group is dirty.	Clean the brew group.
	The coffee exit duct is blocked.	Clean the coffee exit duct with the handle of the measuring spoon or a spoon handle.
	The machine circuit is blocked by limescale.	Descale the machine.
The frothed milk is too cold.	The cups are cold.	Preheat the cups with hot water.
The milk does not froth.	The classic milk frother is dirty or not assembled correctly.	Clean the classic milk frother and make sure it is correctly assembled.
	The type of milk used is not suitable for frothing.	Different types of milk result in different amounts of froth and different froth qualities. We have tested the following milk types which proved to deliver a good milk froth result: semi-skimmed or full-fat cow's milk, soy milk and lactose-free milk. Other types of milk have not been tested and may result in a small amount of milk froth.
I cannot activate the AquaClean filter and the machine asks for descaling.	You have already replaced the AquaClean filter 8 times. After you have replaced the AquaClean filter 8 times, you need to descale the machine.	Descale your machine first and install the AquaClean filter. Always activate the AquaClean filter in the menu (see 'Activating the AquaClean filter'). Also do this when you replace the filter.
	The filter has not been replaced in time after the AquaClean filter icon flashed and the capacity dropped to 0%.	Descale your machine first and then install the AquaClean filter.
	You did not install the AquaClean filter during first installation, but after having brewed approx. 50 coffees (based on 100ml cups). The machine has to be completely limescale-free before you install the AquaClean filter.	First descale the machine and then install a new AquaClean filter. After descaling, the filter counter is reset to 0/8. Always confirm filter activation in the machine menu. Also do this after filter replacement.

Problem	Cause	Solution
	You did not activate the new or replaced AquaClean filter in the machine menu. Also after replacing the filter, you need to confirm activation in the machine menu.	Descalcify your machine first. Then activate the AquaClean filter in the menu (see 'Activating the AquaClean filter'). Also do this when you replace the filter.
The AquaClean filter icon does not appear on the display after I replaced the filter.	You did not confirm activation in the machine menu.	Confirm the activation of the filter in the machine menu. (see 'Activating the AquaClean filter') If the display shows 'START CALC CLEAN', you first need to descale the machine. Remove the AquaClean filter before descaling and reinsert it afterwards.
The AquaClean filter is installed, but the descaling message appears.	You have not activated the AquaClean filter in the machine menu.	First descale the machine and then install a new AquaClean filter. This will reset the filter counter to 0/8. Always confirm filter activation in the machine menu (see 'Activating the AquaClean filter'), also after filter replacement.
The AquaClean filter does not fit.	You need to remove air from the filter.	Let air bubbles come out of the filter.
	There is still water in the water tank.	Empty the water tank before you install the filter.
	You are trying to install another filter than the AquaClean filter.	Only the AquaClean filter fits into the machine.
	The rubber o-ring is not attached to the AquaClean filter.	Check the packaging for the o-ring and attach it to the AquaClean filter.
There is water under the machine.	The drip tray is too full and has overflowed.	Empty the drip tray when the 'drip tray full' indicator pops up through the drip tray. Always empty the drip tray before you start descaling the machine.
	The machine is not placed on a horizontal surface.	Place the machine on a horizontal surface so that the 'drip tray full' indicator works properly.

