

# FRESKO



## V8 Pro Automatic Vacuum Sealer

---

Customer Service: [support@freskoshop.com](mailto:support@freskoshop.com)



# Important Safeguards & Tips

---



## Important Safeguards

- Important Safeguards For your own safety, always follow these basic precautions when using a Food vacuum machine appliance.
- Read the User Manual carefully for operating instructions. Read all instructions in this manual before use.
- Do not use appliance on wet surfaces.
- The liquid entering the machine may cause the machine to fail and damage.
- To prevent electric shock, do not immerse any part of an appliance, power cord or plug in liquid. Unplug the power socket when not in use and before cleaning.
- To disconnect, unplug power cord from electrical outlet. Do not disconnect by pulling on cord.
- If the device fails or is damaged in any way, please contact consumer Services by email. [support@fresko-shop.com](mailto:support@fresko-shop.com)
- Use appliance only for its intended use.
- Closely supervise children when using any electrical appliance. Do not allow appliance to be used as a toy.
- Caution: A short power cord is provided to reduce risks from entanglement or tripping over a longer cord. An extension cord may be used when marked electrical rating is no less than electrical rating of this appliance. All cords should not drape over counter or tabletop where cords can be tripped over or pulled on unintentionally, especially by children.
- Do not place on or near hot gas, electric or heated ovens. Extreme caution must be used when moving products containing hot liquids.

This appliance has a polarized plug (one blade is wider than the other). As a safety feature, this plug will fit in a polarized outlet only one way. If the plug does not fit fully in the outlet, reverse the plug. If it still does not fit, contact a qualified electrician. Do not attempt to defeat this plug safety feature.



## Important Tips

- Vacuum sealing is NOT a substitute for the heat process of canning. Perishables still need to be refrigerated or frozen.
- For best results, use only with Fresko Bag, Rolls, Containers and Accessories.
- During the vacuum sealing process, small amounts of liquids, crumbs or food particles can be inadvertently pulled into the Vacuum Channel. Empty the Drip Tray after each use.
- There should be at least 2 inches (51mm) between the food and the mouth of the vacuum bag. It keeps the bag tightly attached to the food and prevents the bag from pulling out of the vacuum passage. Add at least 2 inches (51mm) to the vacuum bag if reusing it.
- To prevent the vacuum bag from leaking. When inserting the vacuum bag into the machine, pull the vacuum bag opening flat. Insert the vacuum bag into the machine, wait for the vacuum pump to start and press the bag opening before releasing the hand.
- When sealing food with sharp edges, wrap the item in soft cushioning material (such as tissue paper) to prevent puncturing the vacuum bag.
- Use vacuum jars to seal, leaving an inch of space at the top of the jar.
- Cured meats, soups, fruits and vegetables. For best results, pre-chill cured meats, soups, fruits and blanched vegetables before vacuum sealing (see " Part 4: How to use each type of food")

## Package contents:

- 1 x Vacuum Sealer
- 10 x vacuum bag 20 x 30cm
- 1 x Accessory

Check whether the package is complete and whether there are obvious signs of damage.

If the goods are incomplete or damaged due to defects in packaging or transportation, please contact us.

## Introduction to product structure

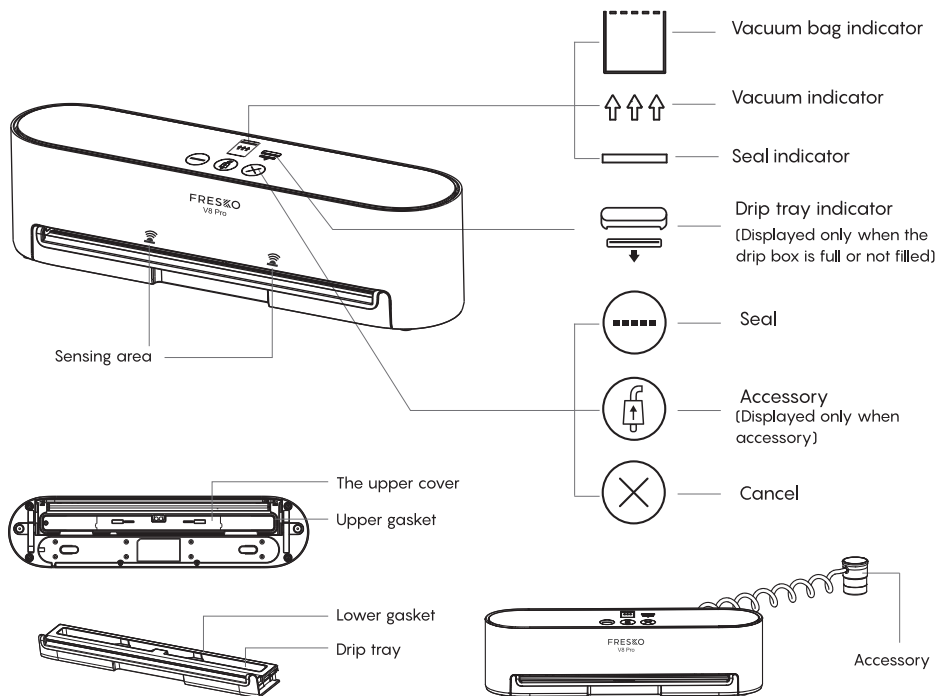

## Product parameters

Model	V8 Pro
Power	120V 60Hz 120W
Product size	16.57 x 4.45 x 4.41 inches
Net weight	4.10lbs

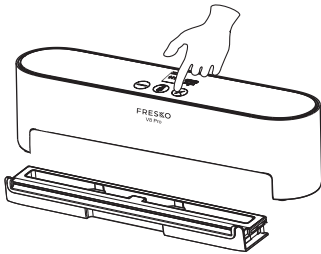

# First time use, activation mode



Remove the drip box and press and hold the "⊗" button icon for 5 seconds, then enter the learning mode. (the vacuum bag indicator flashes and the "⊗" button lights up). At this point the drip box into the machine to activate the automatic sensor full of water function

## How to use each type of food

### Cautions:



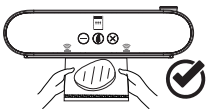

- Automatic standby: If nothing is done for 10 minutes, the machine will automatically go into sleep mode. Trigger the cancel button (⊗) and the machine is woken up.
- drip tray indicator : The machine automatically emits an alarm sound to prompt the cleaning of the residual water and liquid inside.
- The vacuum bag needs to cover two induction points at the same time "  " (if only one induction point is covered, the machine cannot work).

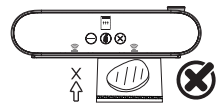
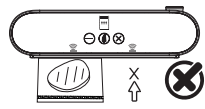
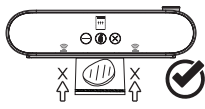

Covering the two induction points



No induction vacuum bag

- If you put in the vacuum bag, the machine does not sense it. You need to take out the vacuum bag (make sure the vacuum bag roll mouth is facing down) and put it into the machine again.
- Touch the switch (⊗): it can stop the running machine.
- The vacuum bag should not contain too much food [leave 2inch(51mm) distance between the food and the bag opening].
- If you need to cut the vacuum bag or roll bag open, please note that the opening needs to be cut straight and neat.
- The automatic working process of the machine: the upper cover is started and the bag mouth of the vacuum bag is pressed → the air of the vacuum bag is extracted (the white indicator light flashes   ) → the seal (the red indicator light flashes ) → the machine stops working (the red indicator light goes out ) ; The upper cover is reset and the standby state is restored).
- Food definition:
  - a) Dry food: food without liquid outflow after extrusion.
  - b) Wet food: food with water on the surface, pickled meat, etc., with liquid flowing out after squeezing, or food with liquid present.

# How to Make a Bag from a FRESKO Vacuum Seal Roll:

After using up the sheet bag we gave you as a gift, you can buy the roll bag for use if necessary.

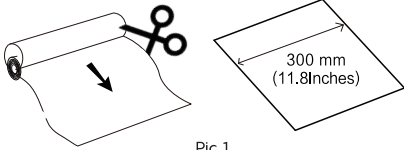

Pic 1

(1) Select a vacuum bag with a width of no more than 300mm(11.8inches), pull the roll bag and cut the roll bag with scissors (Pic 1)

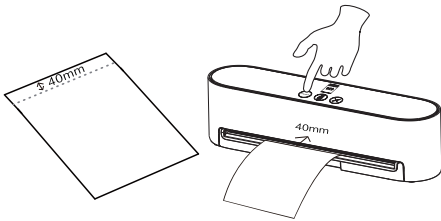

Pic 2&3

(2) Touch "\*\*\*\*\*" (Pic 2)

(3) Roll bag side down, put away the machine (Pic 3)

**\*Note: vacuum bag bent face down**

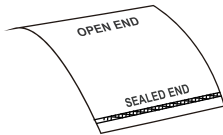

Pic 4

(4) Complete the seal and remove the vacuum bag. (Pic 4)

Washed vegetables (broccoli, peas, carrots, onions, etc.); scalded vegetables; fruits (apples, pears, peaches, avocados), etc., with liquid residue; fresh meat (pork, beef, lamb, chicken, venison, fish, seafood); luncheon meats; cured meats (with marinade attached to the surface). Vacuum bag vacuum seal operation steps.



## Suggestions for use :

Vegetables, fruits, pre-dry with kitchen paper, or use the spinner to shake vegetables, fruits water dry.

## Operating steps for use:

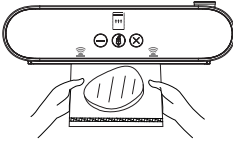

Pic 2

(1) Before placing food into the vacuum bag, use kitchen paper, or a spinner to dry the food, and shake the water (except cured meats), wipe the liquid inside the vacuum bag mouth;

(2) The vacuum bag is inserted into the entrance of the vacuum machine, covering both induction points  at the same time.

(3) Machine starts automatically → after "drip" sound → vacuum sealing is completed (No need to press any touch switches)

**Note:** If the liquid in the drip box is too much, the machine will show the water full prompt light  and automatic alarm sound, you need to promptly clean up the drip box.

(4) Complete the seal and remove the vacuum bag.

**Note:** Before moving, or saving the machine, the drip box must be removed and the liquid emptied.

Pre-cut juicy fruits (watermelon, orange, pear, etc.), fruit salad and other fruits with juice; Powdery food materials such as coffee powder, flour and cereal; Soup, sauce, or leftover steak, beef, pasta and vegetables;



## Vacuum bag vacuum seal operation steps:

---

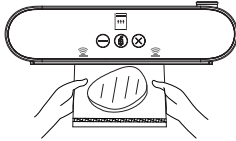

Pic 3

(1) Pre freezing the soup and sauce into a solid;

(2) Put it into the vacuum bag and wipe the liquid at the mouth of the vacuum bag with kitchen paper;

(3) The vacuum bag is inserted into the entrance of the vacuum machine (both induction points  at the same time);

(4) Machine starts automatically → after "drip" sound → vacuum sealing is completed (No need to press any touch switches)

(5) Complete the seal and remove the vacuum bag.

**Note:** Before moving, or saving the machine, the drip box must be removed and the liquid emptied.

## Red wine preservation, nut vacuum jar seal operation steps.

### Red wine

---

Note: used red wine bottle stopper accessories, containers and other items: "only for operation demonstration, not for random standard configuration"



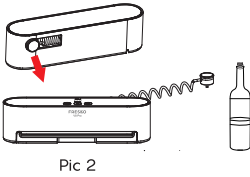

(1) Put the red wine into the red wine stopper.

(2) Remove the external pumping assembly from the back of the machine, unplug the external vacuum plug and remove the transparent part in front of the connector. (Pic 2)

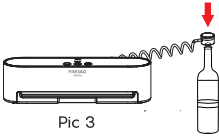

(3) Insert the tip of the external vacuum plug into the wine stopper. (Pic 3)

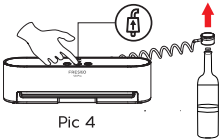

(4) Touch the accessory switch  (the machine will run for about 12 seconds). (Pic 4)

(5) Stop working, remove the accessory and install it back to the original position of the machine.

## Nuts

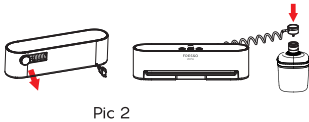

(1) Load the food into the vacuum jar and close the lid.

(2) Remove the accessory from the back of the machine and align one end of the external pumping component with the vacuum tank pumping position. (Pic 2)

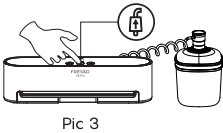

(3) Touch the accessory switch  (the machine will run for about 12 seconds). (Pic 3)

(4) Stop working, remove the accessory and install it back to the original position of the machine.

### Cautions:

- 1, remove the external pumping component, the display shows the external pumping mode, the machine can only use the external pumping function
- 2, the vacuum canister food can not be filled too full [food and canister mouth between the distance left 0.4inch (10mm)]
- 3, the external pumping connector will be aligned with the red wine bottle cork pumping position, and pressed.

Manual, button-pressing operation: hamburger, muffin, bread, sandwich, cake and other soft food.





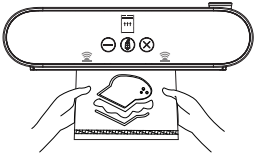

## Vacuum bag vacuum seal operation steps:

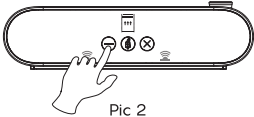

Pic 1



Pic 2

- (1) Put the food into the vacuum bag and flatten the opening with both hands;
- (2) Insert the vacuum bag into the entrance of the vacuum machine while covering the two induction points ; (Pic 1)
- (3) The machine starts automatically (without pressing any touch switch).
- (4) Hands close to the seal switch  (do not touch ) , observe the vacuum level in the vacuum bag, when the air pumped from the vacuum bag has reached the desired effect, touch the seal switch  immediately and the machine will turn to the seal function. (Pic 2)
- (5) Finish the seal, remove the vacuum bag.

### Cautions:

If the machine does not start automatically, please check whether the accessory is installed.

**Dry meat (ham, sausage), bacon, nuts, coffee beans, cat and dog pet food, hollow powder, cereal, hard cheese, solid butter and other dry food and articles.**



## Vacuum bag vacuum seal operation steps:

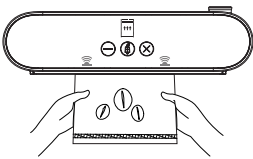

Pic 1

- (1) Put the food in the vacuum bag and pull the opening flat with both hands.
- (2) The vacuum bag is inserted into the entrance of the vacuum machine (covering both induction points ). (Pic 1)
- (3) Machine starts automatically → after "drip" sound → vacuum sealing is completed (No need to press any touch switches)
- (4) Remove the vacuum bag.

### Cautions:

If the machine does not start automatically, please check whether the accessory is installed.

**Separate seal operation steps for fragile food such as potato chips, biscuits, chocolate and popcorn.**



## Vacuum machine separate seal operation steps:

---

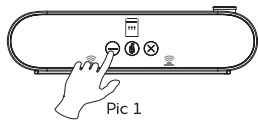

(1) Touch the seal switch (red light  is always on). (Pic 1)

(2) Put the item in the vacuum bag and pull the opening flat.

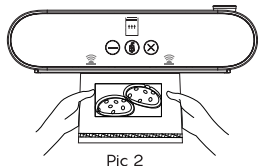

(3) inserting the vacuum bag into the inlet of the vacuum machine while covering the two induction points . (Pic 2)

(4) Machine starts automatically → after "drip" sound → vacuum sealing is completed (No need to press any touch switches)

(5) Complete the seal and remove the vacuum bag.

### Cautions:

If the machine does not start automatically, please check whether the accessory is installed.

## Cleaning

- Unplug the unit before cleaning it.
- Make sure that no moisture can penetrate into the device.
- Do not use aggressive or abrasive cleaning agents, as these can damage the surface of the housing.
- Do not use hard or sharp objects to remove adhesive from the welding wire. Otherwise the welding wire or the insulation could be damaged.
- Clean the surface of the device with a slightly moistened cloth and a mild detergent.
- Wipe off the upper and lower seal rings as well as the press seal with a damp cloth. Make sure the device is dry before using it again.
- **Note: Before moving, or saving the machine, the drip box must be removed and the liquid emptied.**

## Warranty claim procedure

In order to ensure a quick processing of your case, please observe the following notes:

The article number can be found as a sticker on the back or underside of the device. If functional or other defects occur, please contact the specified service center by e-mail.

## Warranty

The guarantee expires in case of improper handling, use of force and internal manipulations which are not carried out by our authorized service center. Your statutory rights are in no way limited by this warranty. The warranty period is not extended by repairs under the warranty. This also applies to replaced and repaired parts. The device has been manufactured with care and carefully checked before delivery.

Please keep your receipt as proof of purchase.

In case of warranty please contact our customer service.

# Guidelines for Vacuum Packaging

## Vacuum Packaging and Food Safety

The vacuum packaging process extends the life of foods by removing most of the air from the sealed container, thereby reducing oxidation, which affects nutritional value, flavor and overall quality. Removing air can also inhibit growth of microorganisms, which can cause problems under certain conditions.

**Mold**—Easily identified by its fuzzy characteristic. Mold cannot grow in a low oxygen environment, therefore vacuum packaging can slow the growth of mold.

**Yeast**—Results in fermentation, which can be identified by smell and taste. Yeast needs water, sugar and a moderate temperature to grow. It can also survive with or without air. Slowing the growth of yeast requires refrigeration, while freezing stops it completely.

**Bacteria**—Results in an unpleasant odor, discoloration and/or soft or slimy texture. Under the right conditions, anaerobic bacteria such as *Clostridium botulinum* (the organism that causes Botulism) can grow without air and sometimes cannot be detected by smell or taste. Although it is extremely rare, it can be very dangerous.

To preserve foods safely, it is critical that you maintain low temperatures. You can significantly reduce the growth of microorganisms at temperatures of 4°C or below. Freezing at -17°C does not kill microorganisms, but stops them from growing. For long-term storage, always freeze perishable foods that have been vacuum packaged, and keep refrigerated after thawing.

It is important to note that vacuum packaging is NOT a substitute for canning and it cannot reverse the deterioration of foods. It can only slow down the changes in quality. It is difficult to predict how long foods will retain their top-quality flavor, appearance or texture because it depends on age and condition of the food on the day it was vacuumed packaged.

### IMPORTANT:

Vacuum packaging is NOT a substitute for refrigeration or freezing. Any perishable foods that require refrigeration must still be refrigerated or frozen after vacuum packaging.

**Food Preparation and Reheating Tips** Thawing and Reheating Vacuum Packaged Foods Always thaw foods in either refrigerator or microwave — do not thaw perishable foods at room temperature.

To reheat foods in a microwave in a bag, always cut corner of the bag before placing it on a microwave-safe dish. However, to avoid hot spots, do not reheat bone-in meat or greasy foods in microwave within a bag. You can also reheat foods in bags by placing them in water at a low simmer below 75°C.

### Preparation Guidelines for Meat and Fish:

For best results, pre-freeze meat and fish for 1-2 hours before vacuum packaging in a bag. This helps retain the juice and shape, and guarantees a better seal.

If it's not possible to pre-freeze, place a folded paper towel between meat or fish and top of bag, but below seal area. Leave paper towel in bag to absorb excess moisture and juices during vacuum packaging process.

### Note:

Beef may appear darker after vacuum packaging due to the removal of oxygen. This is not an indication of spoilage.

### Preparation Guidelines for Hard Cheeses:

To keep cheese fresh, vacuum package it after each use. Make your bag extra long, allowing one inch of bag material for each time you plan to open and reseal in addition

to the 101.6mm room you normally leave between contents and seal. Simply cut sealed edge and remove cheese. When you're ready to repackage the cheese, just drop it in bag and reseal.

**IMPORTANT:**

Due to the risk of anaerobic bacteria, Soft cheeses should never be vacuum packaged.

**Preparation Guidelines for Vegetables:**

Vegetables need to be blanched before vacuum packaging. This process stops the enzyme action that could lead to loss of flavor, color and texture.

To blanch vegetables, place them in boiling water or in the microwave until they are cooked, but still crisp. Blanching times range from 1 to 2 minutes for leafy greens and peas; 3 to 4 minutes for snap peas, sliced zucchini or broccoli; 5 minutes for carrots; and 7 to 11 minutes for corn on the cob. After blanching, immerse vegetables in cold water to stop the cooking process. Finally, dry vegetables on a towel before vacuum packaging.

**Note:**

All vegetables (including broccoli, brussels sprouts, cabbage, cauliflower, kale, turnips) naturally emit gases during storage. Therefore, after blanching, they must be stored in freezer only. When freezing vegetables, it is best to pre-freeze them for 1-2 hours or until solidly frozen.

To freeze vegetables in individual servings, first place on a baking sheet and spread them out so they are not touching. This prevents them from freezing together in a block. Once they are frozen, remove from baking sheet and vacuum package vegetables in a bag. After they have been vacuum packaged, return them to the freezer.

**IMPORTANT:** Due to the risk of anaerobic bacteria, Fresh mushrooms, onions, & garlic should never be vacuum packaged.

**Preparation Guidelines for Leafy Vegetables:**

For best results, use a canister to store leafy vegetables. First wash the vegetables, and then dry with a towel or salad spinner. After they are dried, put them in a canister and vacuum package. Store in refrigerator.

**Preparation Guidelines for Fruits:**

When freezing soft fruits or berries, it is best to pre-freeze them for 1-2 hours or until solidly frozen. To freeze fruit in individual servings, first place on a baking sheet and spread them out so they are not touching. This prevents them from freezing together in a block. Once they are frozen, remove from baking sheet and vacuum package fruit in a bag. After they have been vacuum packaged, return them to the freezer.

You can vacuum package portions for baking, or in your favorite combinations for easy fruit salad all year round. If storing in the refrigerator, we recommend using a canister.

**Preparation Guidelines for Baked Goods:**

To vacuum package soft or airy baked goods, we recommend using a canister so they will hold their shape. If using a bag, pre-freeze for 1-2 hours or until solidly frozen. To save time, make cookie dough, pie shells, whole pies, or mix dry ingredients in advance and vacuum package for later use.

**Preparation Guidelines for Coffee and Powdery Foods:**

To prevent food particles from being drawn into vacuum pump, place a coffee filter or paper towel at top of bag or canister before vacuum packaging. You can also place the food in its original bag inside a bag, or use a universal Lid with the original container to vacuum package.

#### Preparation Guidelines for Liquids:

Before you vacuum package liquids such as soup stock, pre-freeze in a casserole dish, loaf pan or ice cube tray until solid. Remove frozen liquid from pan and vacuum package in a bag. You can stack these "frozen bricks" in your freezer. When you're ready to use, just cut corner of bag and place in a dish in microwave or drop into water at a low simmer, below 75°C. To vacuum package non-carbonated bottled liquids, you can use a bottle Stopper with the original container. Remember to leave at least one inch of room between contents and bottom of Bottle Stopper. You can re-seal bottles after each use.

#### Preparation Guidelines for Make-ahead Meals, Leftovers and Sandwiches:

Efficiently store your make-ahead meals, leftovers and sandwiches in the stackable, lightweight containers. They are microwaveable and top rack dishwasher safe. The lightweight containers will be ready to head off to the office or school when you are!

#### Preparation Guidelines for Snack Foods:

Your snack foods will maintain their freshness longer when you vacuum package them. For best results, use a canister for crushable items like crackers.

#### Vacuum Packaging Non-Food Items

The vacuum packaging system also protects non-food items from oxidation, corrosion and moisture. Simply follow the directions to vacuum package items using bags, Canisters (not included) and Accessories.

To vacuum package silver, wrap fork tines in softcushioning material, such as a paper towel, to avoid puncturing bag. Your bags are ideal for outdoor excursions. For camping and hiking, keep your matches, maps and food dry and compact. To have fresh water for drinking, simply fill a bag with ice, seal it and when needed, let the ice pack melt. If you're going sailing or boating, vacuum package your food, film and a dry change of clothes. Just remember to bring scissors or a knife to open the bag.

To keep emergency kits safe and dry, vacuum package flares, batteries, flashlights, matches, candles and other necessities. Your emergency items will stay dry and organized in your home, car or boat.

# Freshness Comparison Table

Freezer cabinet (41±37.4°F)	Non-vacuum storage	Vacuum storage
meat	2-3 days	12-13 days
seafood and fish	1-3 days	6-8 days
cooked meat	3-5 days	10-18 days
vegetables	3-5 days	7-10 days
fruit	4-6 days	14-20 days
egg	10-15 days	30-50 days

Freezer cabinet (3.2~ -4°F)	Non-vacuum storage	Vacuum storage
meat	2-3 months	1 year
seafood and fish	1-3 months	1 year

Room temperature (77±35.6°F)	Non-vacuum storage	Vacuum storage
meat	1-2 days	6-8 days
rice/flour	2-4 days	over 1 year
peanut/dried beans/tea	2-3 days	over 1 year

**Note:** The fruit itself will release gas for ripening effect, and it is easy to deteriorate in a closed environment. It is recommended to keep it fresh for a short time, not for long.

# Troubleshooting

No	Problem	Reason	Solution
1	The indicator does not light up, the key does not respond	The machine is not plugged into the power	Plug in the power
		User's fingers or machine touch keys with liquid such as sweat, oil stains, or dust. Electrostatic interference in winter.	Dry the machine touch screen and fingers with a soft dry cloth. Retouch
2	Put in the vacuum bag, the machine does not respond	Not plugged in, or no power to the electrical outlet	Plug in the power; replace the socket
		Vacuum bag roll mouth up, into the machine, did not trigger the induction function	Remove the vacuum bag, roll the mouth down and put it back into the machine.
		The vacuum bag did not cover the two induction points	Vacuum bag to cover two induction points
3	Vacuum, sealed after the vacuum bag, save a period of time, air leakage	Seal position with foreign matter, vacuum bag seal position with air bubbles	Keep the machine seal position clean
		Vacuum bag mouth is not flush, bag mouth roll mouth, there are creases, not completely into the machine	Keep the opening of the vacuum bag flush and put it into the machine to the drip box stopper position (about 50 mm). If the vacuum bag opening is rolled, place it into the machine with the rolled opening facing downward.
		Vacuum bags are punctured by food (sealed bones, or food with sharp edges)	Check the bag to make sure no sharp food has punctured the vacuum bag. Seal bones, or food with sharp edges, use paper towels to separate the sharp edges from the vacuum bag to avoid the vacuum bag being punctured
4	Seal effect is not good, there is an obvious gap of air leakage	Too much liquid from food	Freeze food as solid, then vacuum seal or pour off part of the liquid, then vacuum sea
5	Vacuum bag seal is melted	The use of bags "non-vacuum packaging machine special vacuum bags (not high temperature resistant)	Use of vacuum bags suitable for vacuum packaging machines
		The high temperature tape on the surface of the machine heating component is broken	Keep seal area clean/ tape intact (torn need to be replaced)
		Continuous work, heating wire overheating	Let the machine stand and cool naturally for about 15 minutes



No	Problem	Reason	Solution
6	Vacuum bag seal with white spots, air bubbles, air leakage	Heating wire bulge	Using a round metal bar, roll to flatten the bumps
7	" ---- " seal indicator flashes continuously	The machine enters the overheat protection state and the use of the function use is restricted	Leave the machine, unplug the power cord, natural cooling for about 15 minutes, plug in the power cord, wait for the button panel to light up, you can resume use
8	Accessory function failed	Gasket leakage, not installed properly	Reinstall the gasket
9	Vacuum bag air can not be extracted, about 45 seconds before sealing; vacuum bag can only be extracted part of the air, the machine pumping, about 45 seconds before sealing	The vacuum bag is broken, the bag opening is not cut flat, creased, overlapping	Apply intact vacuum bag, keep the bag opening cut smoothly, no damage to the bag
		The vacuum bag is not properly placed in the machine	Vacuum bag roll mouth down, put the bag mouth correctly into the vacuum cavity
		Too much food in the vacuum bag (no blank space of at least 50mm reserved)	Reduce the food in the vacuum bag, re-vacuum and seal
		Vacuum bag opening width greater than 300mm	Use vacuum bags suitable for vacuum machines (size: 200mm*300mm bags)
		The use of vacuum bags that are not striped and bumpy	Use striped, bumpy vacuum bags
		Machine sealing work area is not flat, there are foreign objects	Keep the machine sealing work area clean and free of foreign objects
		Loose gasket, leakage	Installing the gasket correctly into the machine
		The outer tap does not fit into the outer tap hole, or is not fully plugged	Install the outer tap correctly into the machine and press it firmly
10	The drip box prompt light flashes	Food liquid is sucked into the drip box to an early warning level	Remove the drip box, pour out the water, and use paper towels to dry the liquid from the drip box slot, and the surface of the gasket.
11	The water is full, the drip box tip light is not flashing	No full water mode activated	Remove the drip box long press the "cancel" key icon for 5 seconds, enter the learning mode (green vacuum bag icon flashing, "cancel" key icon long light), then the drip box into the machine can be activated automatically sensor full of water function.

# ENVIRONMENT FRIENDLY DISPOSAL

## Disposal:



Guideline 2012/19/EC concerning the handling, collection, recycling and disposal of electrical and electronic equipment and their components 'waste electrical and electronic equipment', known as WEEE"

The crossed symbol on a rubbish container indicates that the machine or device is not allowed to be disposed of, but must be handed over to an appropriately equipped collection point for proper recycling or disposal.

## Direttive:



The packaging materials have been selected for their environmental friendliness and ease of disposal and are therefore recyclable. Dispose of packaging materials that are no longer needed in accordance with applicable local regulations.



# FRESKO

Fresko reserves the right to modify this manual, please refer to the actual product received.

## **Manufacture: Bosen Electronics Limited**

 : No.11-12, Lun Pin Chong Industrial Zone San Tun Community, Hou Jie Town 523941 Dongguan City, Guangdong PEOPLE'S REPUBLIC OF CHINA

 : [support@freskoshop.com](mailto:support@freskoshop.com)

**Made in China**