

Professional riveting technology

**X**Series  
WS

**X**Press 800  
WS

**X**Press WORKSTATION  
WS

**X**Pac  
WS

InduPac 1000

**X**Tend  
WS





The WS Wieländer+Schill GmbH & Co. KG is one of the world's leading manufacturers of professional car body repair tools. Founded over 45 years ago, WS Wieländer+Schill has developed into an internationally successful company through close cooperation with leading car manufacturers.

Car body technology is in a constant state of change and constantly presents the repair market with new challenges. We have therefore made it our mission to develop innovative products with high quality standards that make everyday life noticeably easier for our customers.

**Our goal is for 100 % customer satisfaction.**

TESTED AND APPROVED BY:

JAGUAR LANDROVER  
 GENERAL MOTORS  
 MERCEDES-BENZ  
 HONDA  
 TESLA  
 FORD  
 NIO

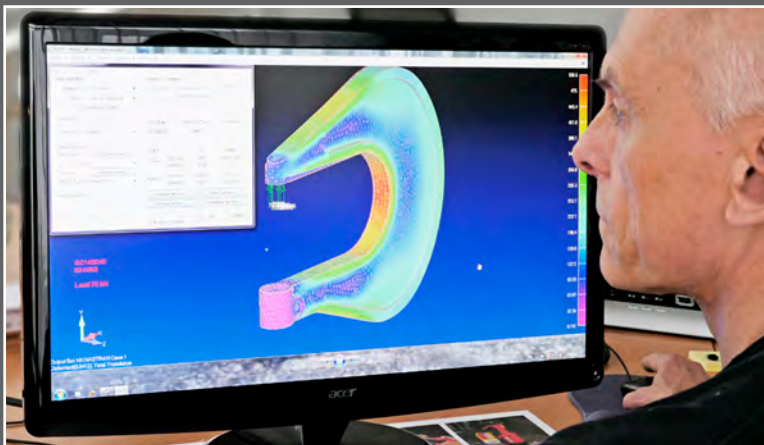
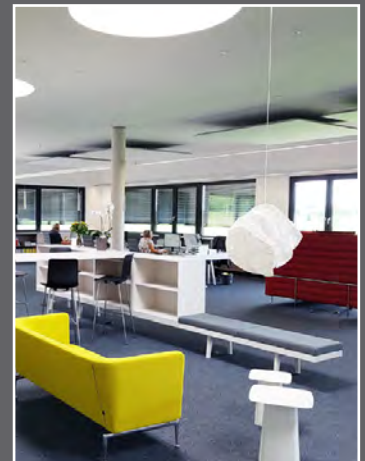

**WS** Wieländer+Schill®

- ↑ Anmeldung Büro
- ← Kundenparkplatz
- ← Warenannahme
- ← Versand

Neue Wiesen 8  
 78609 Tuningen

**Riveting tools of the XSeries**

XPac	Page 5
XPress 800	Page 6
XPress Workstation	Page 8
InduPac 1000	Page 10
XTend	Page 11
XPull	Page 13

**Sets of riveting tools**

XPress 800 Basic Set	Page 12
XPress 800 Standard Set	Page 12
XPress 800 Full Set	Page 12
PushPull Upgrade-Kit	Page 13
XPress 800 PushPull Basic Set	Page 14
XPress 800 PushPull Standard Set	Page 14
XPress 800 PushPull Full Set	Page 14
PushPull supplementary kit for self-piercing rivets	Page 15

**Riveting tool modules**

PowerPack XPress 800	Page 16
----------------------	---------

**Short stroke cylinders**

Short stroke cylinder SSC 35/25	Page 16
Short stroke cylinder SSC 40/25	Page 16
Short stroke cylinder PP90	Page 16
C-arms	Page 17

**Pull cylinders**

Blind rivet adapter BR20	Page 18
Blind rivet adapter BR50	Page 18
Blind rivet adapter BR80	Page 18
Blind rivet nut adapter BRN50	Page 19

**Accessories**

XPress 800 trolley	Page 13
Service kit XPress	Page 15
Face protection	Page 15

**Accessories for pull cylinders**

Mouthpieces BR20/BR50	Page 20
Blind rivet nuts BRN50	Page 21
Blind rivets	Page 21

**Accessories for short stroke cylinders**

Self-piercing rivets	Page 22
Flow-form rivets FFN	Page 22
Countersunk flow-form rivets SFFN	Page 22
Punching crowns SKR	Page 21

**RivBox assortment box**

RivBox N°1 - Standard	Page 23
RivBox N°2 - Mercedes-Benz	Page 23
RivBox N°3 - General Motors	Page 23

**Riveting and punching tools**

Tool Boxes	Page 24
Matrices   Setting dies   Extraction mandrels	Page 26
Extensions   Adapters   Center Punch	Page 27



# XSeries

## THE PRODUCT FAMILY OF WS WIELÄNDER+SCHILL RIVETING TOOL TECHNOLOGY

### MODULAR TECHNOLOGY

Enables the processing of different rivets with only one tool by using different adapters

### HIGH PRESSING FORCE

Depending on the application and cylinder, high pressing forces can be achieved, such as those required for punching ultra-high strength steel

### OPTIONALLY COMBINABLE

The adapters and dies are interchangeable within the **XSeries** product family

### INDIVIDUAL TOOL SETS

The riveting system is supplemented by a large number of special tools for **customer-specific applications** for automotive production

### HIGHEST QUALITY

Customer satisfaction is our top priority, therefore we pay attention to the best quality of our products

### RELIABLE SERVICE

We offer fast and professional support by qualified personnel

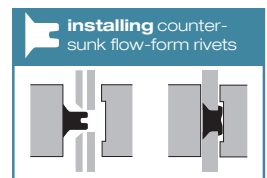
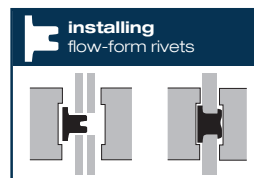
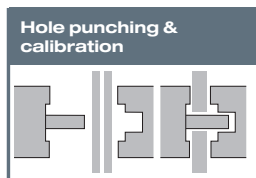
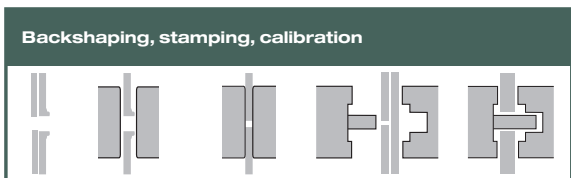
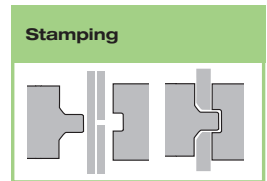
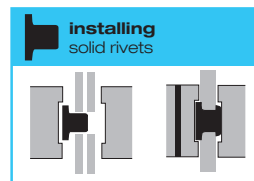
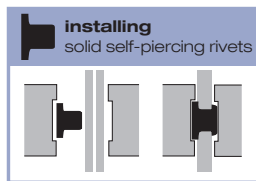
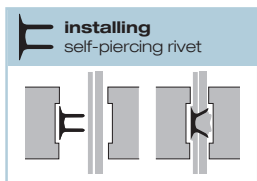
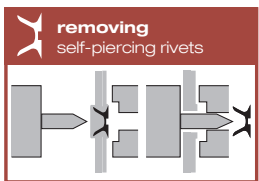

# THE INNOVATION IN RIVETING TECHNOLOGY

The new compact XPac is a mechanically driven Hydraulic actuator which generates pressure forces up to **80 kN**.

# XPac

## SIMPLE HANDLING

The wireless mode of operation enables a significantly simplified work process.

## DIRECT FORCE ADJUSTMENT

The automatic limit switch-off after reaching the set force guarantees a safe application.

## QUICK ASSEMBLY

The XPac and the torque arm can be mounted quickly and easily on almost all standard cordless screwdrivers\*.

## VERSATILE APPLICATION

**Self-piercing rivets**  
**Flow-form rivets**  
**Countersunk flow-form rivets**  
**Solid self-piercing rivets**  
**Solid rivets**  
**Pressing out**  
**Backshaping**  
**Calibration**  
**Hole punching**  
**Stamping**



Dimensions	240x62x130 mm
Height incl. torque bracket	290 mm
Weight kpl.	3.41 Kg
Oil volume	60 cm <sup>3</sup>

Press force	25 kN - 80 kN
Cylinder stroke	25 mm
Required speed ( <i>drive</i> )	1250 - 1500 rpm
Required torque	12.5 Nm

\*with minimum technical requirements of a torque of > 12.5 Nm and a speed of 1250 - 1500 rpm

## XPac Basic Set for self-piercing rivets

item N° 703510

The following applications are possible with the basic set:

- **installing self-piercing-rivets**
- **removing self-piercing-rivets**

Scope of delivery:  
1 x **XPac** incl. torque bracket  
1 x C-arm GC 80/40  
1 x Tool Box **RS-03**  
1 x red handle  
1 x assembly/operating instructions



Note: Cordless screwdriver/drill is not included in delivery

**modularly  
expandable**

# WS **XPress 800**

## MODULAR RIVETING SYSTEM



- Self-piercing rivets
- Flow-form rivets
- Countersunk flow-form rivets
- Solid rivets
- Solid self-piercing rivets
- Blind rivets
- Blind rivet nuts
- Blind rivet bolts
- Pressing out
- Backshaping
- Calibration
- Hole punching
- Stamping



**FOR PROCESS-SAFE  
VEHICLE REPAIR**



pressing out

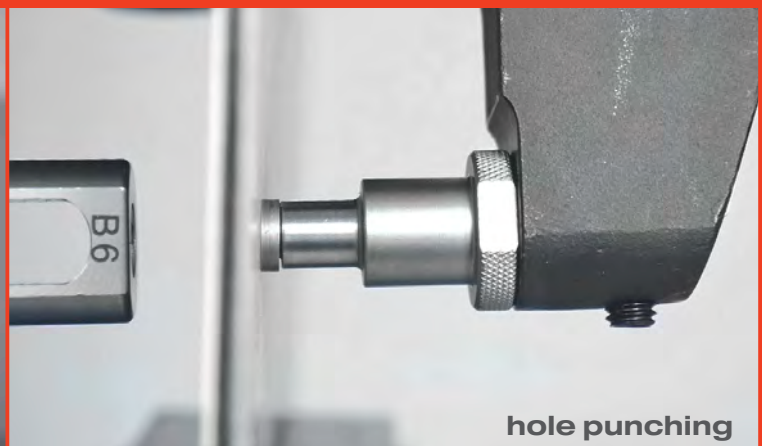

hole punching

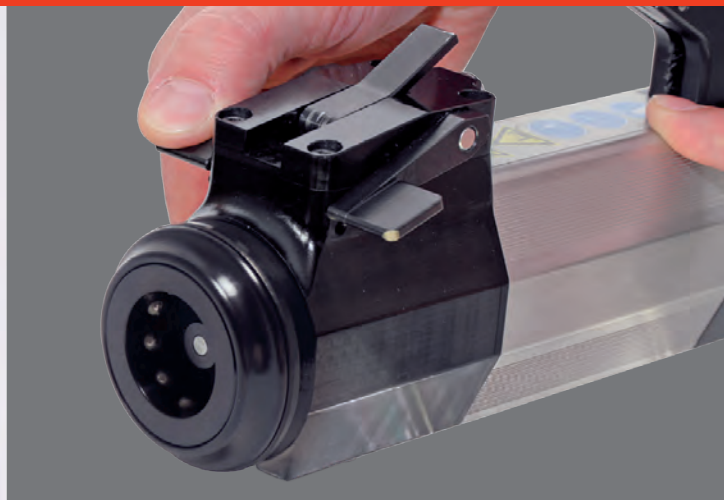

## QUICK-STOP

The STOP button allows the currently coupled tool to be stopped in any position without releasing the pressure.



## QUICK-LOCK



Quick and easy installation thanks to the quick-lock function. Replacement of the adapters by simply pressing the locking ring.



## WITH INNOVATIVE PRESSURE CONTROL



Countersunk flow-form rivets

### TECH. SPECIFICATIONS

Permissible hydraulic oil	Hydraulic oils according to DIN 51524   AFT oils according to DIN 51562-2   Type HLP 22 - HLP 36
Oil viscosity	approx. 22 - 36 mm <sup>2</sup> /s at 40°C
Oil filling quantity	90 cm <sup>3</sup>
Air pressure max.	6 bar / 87 psi
compressed air	Quality class 2 (ISO 8573-1)
Temperature (ambient)	5 - 50 °C / 41 - 122°F
Prescribed safety clothing	Protective gloves and face protection
Emission sound pressure level	75 dB (A) LPAI
Emission sound pressure level	< 2.5m/s <sup>2</sup> (ISO/FDIS B662-11)

TESTED &  
 RECOMMENDED **by**  
 JAGUAR LAND ROVER

Reg. N° JLRBSST006

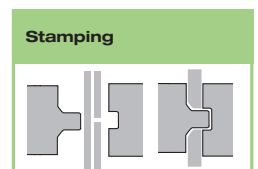
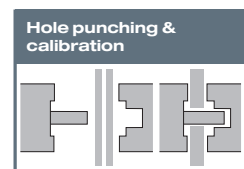
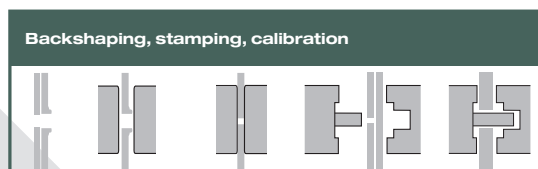
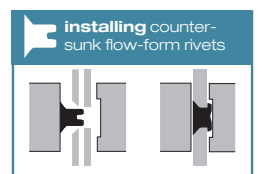
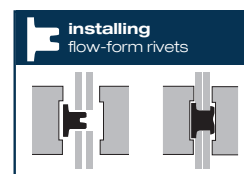
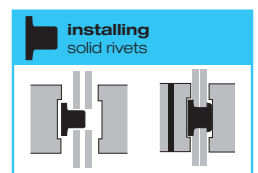
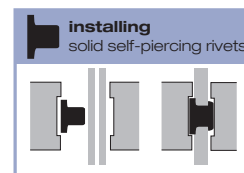
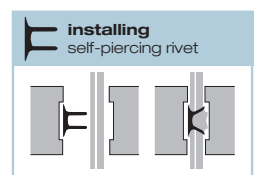
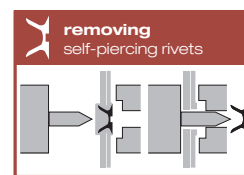





## PRESSURE MONITORING SYSTEM WITH PATENTED XLOGIC TECHNOLOGY

The innovative system and the air tank integrated in the tubular frame of the trolley guarantee the user full process reliability\* during riveting work on the vehicle. Even if the air supply is unexpectedly interrupted, the riveting process can be carried out safely\*.

\*Note: Process reliability during riveting is ensured by using the SSC 40 mm short-stroke cylinder. (included in delivery)

### PROCESS-RELIABLE

guarantees full process reliability due to the **XLogic** pressure monitoring and the integrated air tank in the tubular frame

### PNEUMOHYDRAULIC

### 100% COMPATIBLE

full compatibility with all modules of the XPress 800 system

### HIGH TRACTION FORCE

Tensile force up to 80 kN\*  
 Press force from 10 - 80 kN



#### Full Set

item N° F700058

- 1x Workstation incl. **XLogic**
- 1x Short stroke cylinder SSC 40 mm
- 1x XPress Power Pack
- 1x blind rivet adapter BR 20
- 1x blind rivet adapter BR 50
- 1x Tool Box RS-06 V4 (JLR)
- 1x blind rivet nut adapter BRN 50
- 1x Tool Box RS-04 (BRN 50)
- 1x C-arm GC 80/40
- 1x C-arm GC 80/120
- 1x C-arm GC 140/240
- 1x spiral compressed air hose 4 m



#### Standard Set

item N° S700058

- 1x Workstation incl. **XLogic**
- 1x Short stroke cylinder SSC 40 mm
- 1x XPress Power Pack
- 1x Tool Box RS-06 V4 (JLR)
- 1x C-arm GC 80/40
- 1x C-arm GC 80/120
- 1x C-arm GC 140/240
- 1x spiral compressed air hose 4 m

## WS XPress WORKSTATION



#### Upgrade Set

item N° 700058

- 1x Workstation incl. **XLogic**
- 1x Short stroke cylinder SSC 40 mm
- 1x spiral compressed air hose 4 m

# FOR INDUSTRY AND AUTOMOTIVE TRADE



**FOR MANUAL AND  
SEMI-AUTOMATIC PROCESSES**

**COMPACT  
MODULAR  
DURABLE  
FAST  
EFFICIENT  
LOW MAINTENANCE**

The reliable, economical solution for

# RIVETING PUNCHING STAMPING

and processing various joining elements

## InduPac 1000

A new type of hydraulic supply station for industrial applications (e.g. riveting technology) where high forces are required via hydraulically driven tools.

The device was developed for continuous operation in industry and trade and is unrivalled on the market with the matching tools from the XSeries as pressure generators.

Production processes can be made more reliable and cheaper and the maintenance and operating costs are

reduced to a minimum because the InduPac 1000 has only one moving part.

These factors can influence the production process drastically reduce manufacturing costs.

### TECH. DATA

length	width	height	weight	PB max
259 mm	56 mm	213 mm	2.65 kg	800 bar



CEILING SUSPENSION  
**ADAPTS TO ANY ENVIRONMENT**  
 TROLLEY  
 STATIONARY



### Indupac 1000 SC with XTend and trolley

item N° 700055

For manual use of all XSeries components in Connection with the Indupac 1000

The „SC“ function divides the working process into 2 stages

„Positioning & Working“

**InduPac 1000**



### XTend SC riveting tool

item N° 700035

Adaptive riveting tool for stationary hydraulic-pneumatic pumps such as Indupac 1000 etc.

- Self-piercing rivets**
- Flow-form rivets**
- Countersunk flow-form rivets**
- Solid rivets**
- Solid self-piercing rivets**
- Blind rivets**
- Blind rivet nuts**

- Blind rivet bolts**
- Pressing out**
- Backshaping**
- Calibration**
- Hole punching**
- Stamping**

**XTendSC**



Weight	Hose length
2.60 kg	4.0 m

**MATCHING MODULES & ACCESSORIES**

from Page 14

## XPress 800 Basic-Set

item N° 700000

- installing self-piercing-rivets
- removing self-piercing-rivets

Scope of delivery:

- 1 x Power Pack cpl.
- 1 x short stroke cylinder SSC35/25
- 1 x C-arm GC 80/40
- 1 x Tool Box RS-03
- 1 x transport case
- 1 x operating instructions

**XPress 800**



## XPress 800 Standard-Set

item N° 700001

- installing self-piercing-rivets
- removing self-piercing-rivets

Scope of delivery:

- 1 x Power Pack cpl.
- 1 x short stroke cylinder SSC35/25
- 1 x C-arm GC 80/40
- 1 x C-arm GC 80/120
- 1 x C-arm GC 140/240
- 1 x Tool Box RS-03
- 1 x transport case
- 1 x operating instructions

**XPress 800**



## XPress 800 - Full Set

item N° 700002

- installing self-piercing-rivets
- removing self-piercing-rivets
- installing blind rivets
- installing blind rivet nuts

Scope of delivery:

- 1 x Power Pack cpl.
- 1 x short stroke cylinder SSC35/25
- 1 x blind rivet adapter BR20
- 1 x blind rivet adapter BR50
- 1 x blind rivet nut adapter BRN50
- 1 x C-arm GC 80/40
- 1 x C-arm GC 80/120
- 1 x arm GC 140/240
- 1 x Tool Box RS-03
- 1 x Tool Box RS-04
- 1 x transport case
- 1 x operating instructions



**XPress 800**



**PushPull - Upgrade-Kit**

item N° 700004

An addition to existing XPress 800 Sets for:

- removing self-piercing-rivets
- installing flow-form rivets
- installing solid self-piercing rivets
- backshaping
- calibration
- hole punching

Scope of delivery:

- 1 x retraction cylinder PP90
- 1 x Tool Box RS-07
- 1 x operating instructions

**PushPull**



**Tool trolley for XPress 800 riveting tools**

item N° 700010

- beech worktop - thickness 25 mm
- Full extension with soft closing
- Partially integrated handle strips
- 2 fixed and 2 swivel castors
- dimensions 770 x 650 x 795 mm



**XPull - manual riveting tool**

item N° 700098

The XPull is a mechanical-hydraulic power amplifier which allows to generate a setting force of up to 20 kN with a mere hand force. The power transmission ratio is 1:8.

Furthermore, the XPull guarantees the use of all currently listed WS-tension adapters such as Tool Box RS-04.

Delivery including pulling adapter **M10** for blind rivet nuts with **left-hand thread**.



**XPress 800 incl. PushPull**

item N° 700003 Basic Set

Modular riveting system with a force-supporting retraction cylinder for the installation of rivets in hard and ultra-hard structural parts and for:

- removing self-piercing-rivets
- installing flow-form rivets
- installing solid self-piercing rivets
- backshaping
- calibration
- hole punching

Scope of delivery:

- 1 x Power Pack cpl.
- 1 x retraction cylinder PP 90
- 1 x C-arm GC 80/40
- 1 x Tool Box RS-07
- 1 x transport case
- 1 x operating instructions

**PushPull**



tested and approved

Mercedes-Benz

**XPress 800 incl. PushPull**

item N° 700006 Standard Set

Modular riveting system with a force-supporting retraction cylinder for the installation of rivets in hard and ultra-hard structural parts and for:

- removing self-piercing-rivets
- installing flow-form rivets
- installing solid self-piercing rivets
- backshaping
- calibration
- hole punching

Scope of delivery:

- 1 x Power Pack cpl.
- 1 x retraction cylinder PP 90
- 1 x C-arm GC 80/40
- 1 x C-arm bracket GC 80/120
- 1 x C-arm bracket GC 140/240
- 1 x Tool Box RS-07
- 1 x transport case
- 1 x operating instructions

**PushPull**



tested and approved

Mercedes-Benz

**XPress 800 incl. PushPull**

item N° 700005 Full Set

Modular riveting system with a force-supporting retraction cylinder for the installation of rivets in hard and ultra-hard structural parts and for:

- removing self-piercing-rivets
- installing flow-form rivets
- installing solid self-piercing rivets
- backshaping
- calibration
- hole punching
- installing blind rivets
- installing blind rivet nuts

Scope of delivery:

- 1 x Power Pack cpl.
- 1 x retraction cylinder PP 90
- 1 x blind rivet adapter BR 20
- 1 x blind rivet adapter BR 50
- 1 x blind rivet nut adapter BRN 50
- 1 x C-arm GC 80/40
- 1 x C-arm GC 80/120
- 1 x C-arm GC 140/240
- 1 x Tool Box RS-04
- 1 x Tool Box RS-07
- 1 x transport case
- 1 x operating instructions

**PushPull**



tested and approved

Mercedes-Benz

## PushPull - Extension kit for self-piercing rivets

item N° 700009

The extension kit enables the processing of self-piercing rivets and the use of all Tool Boxes with already existing **PushPull**-Sets.

Scope of delivery:

- 1 x short stroke cylinder SSC35/25
- 1 x C-arm GC 80/40
- 1 x extension F1



## Service Kit EB-XP 800

item N° 700334

Venting and filling device for Power Pack XPress 800

Scope of delivery:

- 1 x special pump oiler (volume 250 ml)
- 1 x plug-in coupling
- 1 x filling port
- 1 x clear tube 6x4 mm
- 1 x clear tube 8x5 mm
- 1 x hydraulic oil HLP22 / PU 250 ml



## Hydraulic oil HLP22

item N° 700102 | 250 ml

**XPress 800** - Special oil for the service and maintenance of the Power Pack, the blind rivet adapters and the **PushPull**.



## ProtectSHIELD face protection

item N° 881031

An uncompromising face protection that meets all requirements in terms of safety and ergonomics in a practical way 100%.

- patented visor attachment
- breathable headband
- wide field of view
- easy and fast head adjustment
- adjustment knobs are adjustable with gloves



## Power Pack pneumatic-hydraulic

item N° 700050

The Power Pack is a pneumatic-hydraulically driven pressure intensifier with a two-stage high-pressure pump. With a primary air pressure of 6 bar a hydraulic secondary pressure of 800 bar is generated.

length	width	height	weight	PB max	oil volume
259 mm	56 mm	213 mm	2.65 kg	800 bar	80 cm <sup>3</sup>



## Short stroke cylinder SSC 35/25

item N° 700060

stroke	weight	PB max.	F max.
25 mm	1.4 kg	800 bar	77 kN



## Short stroke cylinder SSC 40/25

item N° 700067

First use: **Jaguar Land Rover - Workstation**

stroke	weight	PB max.	F max.
25 mm	1.68 kg	800 bar	100 kN



## PushPull cylinder PP 90

item N° 700105

Pressure cylinder with 2-way function: push and pull

**PushPull**

stroke	weight	PB max.	F max.
16 mm	2.6 kg	800 bar	90 kN





C-arms			
item N°	700070	700071	700072
name	80/40	80/120	140/240
operating window	80 x 40 mm	80 x 120 mm	140 x 240 mm
weight	2 kg	4 kg	10 kg
	with safety interlock	with safety interlock	with safety interlock



## C-arm set

item N° 700080

Scope of delivery:  
 1 x C-arm GC 80/120  
 1 x C-arm GC 140/240  
 1 x extension 93 mm  
 1 x extension 60 mm  
 1 x transport case



## Verlängerung für C-Arm 140/240

name	for short stroke cylinder SSC 35/25 <b>replaces extension F1</b>	for short stroke cylinder SSC 35/25 and PushPull cylinder PP 90
item N°	700517	700153
length	93 mm	60 mm



**Blind rivet adapter BR20**

item N° 700100

Our **smallest pulling adapter** for the global market!  
**Traction force 20 kN**

- freely tiltable and rotatable
- for rivets with shaft: Ø 2.0-4.2 mm
- extremely good accessibility for challenging riveting tasks

dimensions	stroke	weight	F max.	swivel angle	interlock steps
100x56x74.5mm	22 mm	1.0 kg	20 kN	120°	30°



incl. mouthpieces

**Blind rivet adapter BR50**

item N° 700101

The power package designed for the future!  
**Traction force 50 kN**

- freely tiltable and rotatable
- for rivets with shaft: Ø 2.0-5.0 mm
- extremely good accessibility for challenging riveting tasks

dimensions	stroke	weight	F max.	swivel angle	interlock steps
252 x 56 mm	25 mm	1.5 kg	50 kN	120°	30°



incl. mouthpieces

**Blind rivet adapter BR80**

item N° 700112

The universal pull cylinder for multiple applications!  
**Traction force kN**

- ultra high strength blind rivets and nuts
- HUK Bom
- studs
- bolts
- Magna Grip



dimensions	stroke	weight	F max.	swivel angle	interlock steps
200 x 112 mm	25 mm	2.5 kg	80 kN	120°	30°



SELECT THE MATCHING ADAPTER  
 ACCORDING TO YOUR NEEDS

**Extensions & pulling adapters for BR50/BR 80**

item N°	extensions		pulling adapters			
	700150	700151	700138	700139	700136	700137
name	BR 50	BR 50	BR 50	BR 50	BR 80	BR 80
length	100 mm	150 mm	55 mm	55 mm	65 mm	65 mm
Ø	2.0 - 5.0 mm	2.0 - 5.0 mm	3.0 - 5.5 mm	5.5 - 7.0 mm	3.0 - 5.5 mm	5.5 - 7.0 mm

**NEW**



only for standard mouthpieces

# Pull cylinders

## Blind rivet nut adapter **BRN50**

item N° 700110

With stepless variable pulling length adjustment!  
Traction force 50 kN

- perfect installation control
- freely rotatable and tiltable
- for riveting nuts M4-M12, threaded bolts, pins, etc.



dimensions	stroke	weight	F max.	swivel angle	interlock steps
241 x 56 mm	16 mm	1.65 kg	50 kN	120°	30°

## Set - blind rivet nut adapter BRN50 incl. Tool Box RS-04

item N° 700111

Scope of delivery: Blind rivet nut adapter BRN 50 + Tool Box RS-04



### Pulling adapter for blind rivet nuts for BRN50

	item N°	thread	thread-length	
	700324	M4	25 mm	
	700325	M5	25 mm	
	700326	M6	30 mm	
	700327	M8	25 mm	
	700328	M10	25 mm	
	700305	M12	30 mm	
	700124	M10 left-hand thread	25 mm	
	700129	M12x1.5	30 mm	

### Tool Box RS-04

item N° 700201



Set of pulling adapters for blind rivet nuts consisting of: M4, M5, M6, M8, M10, M12

### Pulling adapter for blind rivet studs for BRN50

item N°	700127	700123	700122	700120	700121
thread	5 mm RivBolt	6 mm RivBolt	M8	M6	self lock



## Standard mouthpieces for BR20/BR50

for processing of blind rivets

item N°	700204	700215	700524	700525	700532
name	Tool Box (4 pcs.)	Tool Box (7 pcs.)	3.2 C	3.6 C	3-AL
Ø mm	3.2 - 4.5	3.2 - 5.1	3.2	3.6	
	3.2A 3.6A 4.0A 4.5A	3.2A 4.5B 3.6A 4.8B 4.0A 5.1B 4.5A	for blind rivets in the area of the roof rail	for blind rivets in the area of the roof rail	for blind rivets with extra long shaft
BR20	X		X	X	X
BR50	X	X	X	X	X



## Standard mouthpieces for BR20/BR50

item N°	flat head				concave head		
	700518	700519	700520	700521	700523	700522	700359
name	3.2A	3.6A	4.0A	4.5A	4.5B	4.8B	5.1B
Ø mm	3.2	3.6	4.0	4.5	4.5	4.8	5.1
					for RIBE blind rivets	for RIBE blind rivets	
BR20	X	X	X	X			
BR50	X	X	X	X	X	X	X



## Mouthpieces for BR50/BR80

for processing of blind rivets

extraction of self-piercing rivets with welding studs



item N°	for processing of blind rivets				extraction of self-piercing rivets with welding studs					
	703131	703132	703133	703134	for aluminum			for steel		
Ø mm	5.1 - 5.5	4.5 - 5.1	4.0 - 4.5	3.4 - 4.0	3.0 - 4.0	4.0 - 5.0	6.0 - 6.5	3.0 - 4.0	4.0 - 5.0	6.0 - 6.5
BR50 3-5.5 mm	X	X	X	X	X	X		X	X	
BR50 5.5-7 mm							X			X
BR 80 3-5.5 mm	X	X	X	X	X	X		X	X	
BR 80 5.5-7 mm							X			X



color may vary

## Blind rivet nuts for BRN50

item N°	777203	777204	777205	777206	777207	777208
name	M4	M5	M6	M8	M10	M12
dimensions	6.0 x 11.0 mm	7.0 x 11.5 mm	9.0 x 15.5 mm	11.0 x 17.0 mm	12.0 x 17.5 mm	15.9 x 23.0 mm
material	steel	steel	steel	steel	steel	steel
sales unit	25 pcs.	25 pcs.	25 pcs.	10 pcs.	10 pcs.	5 pcs.



## Rivet screws for BRN50

item N°	777247	777267	777246
name	M6	M8	SelfLock
Ø	6 mm	8 mm	6 mm
material	steel	steel	steel
sales unit	10 pcs.	10 pcs.	10 pcs.



## Blind rivets

item N°	777227	777228	777229	777231	777230	777215	777216	777217
name	blind rivet 4 x 6	blind rivet 5 x 6	blind rivet 6 x 8	blind rivet 6 x 10	blind rivet RIBE	blind rivet AUDI	blind rivet BMW	blind rivet BMW
Größe	4.0 x 6.0 mm	5.0 x 6.0 mm	6.0 x 8.0 mm	6.0 x 10.0 mm	6.5 x 12.5 mm	6.5 x 15.0 mm	6.5 x 14.0 mm	6.5 x 16.0 mm
Material	aluminium	aluminium	aluminium	aluminium	galvanized	steel	steel	steel
BR20	X	X	X	X				
BR50	X	X	X	X	X	X	X	X
BR50 3-5.5 mm					X	X	X	X
BR50 5.5-7 mm								
BR 80								
BR 80 3-5.5 mm					X	X	X	X
BR 80 5.5-7 mm								
sales unit	40 pcs.	40 pcs.	40 pcs.	40 pcs.	25 pcs.	10 pcs.	10 pcs.	10 pcs.



## Punching crowns SKR

Ø mm	6.0	6.7	8.0
item N°	700141	700142	700140
sales unit	50 pcs.	50 pcs.	50 pcs.



**Note:** When using Flow Form Rivets (FFN) and Countersunk Flow Form Rivets (SFFN), the description of the working process and the application areas of the corresponding repair instructions of the vehicle manufacturer (OEM) must be observed. In principle, a test rivet must always be installed whenever the material or the material thickness is changed. This is the only way to ensure a reliable riveting process. This applies to all rivets from the WS Wieländer+Schill range.



**Self-piercing rivets**

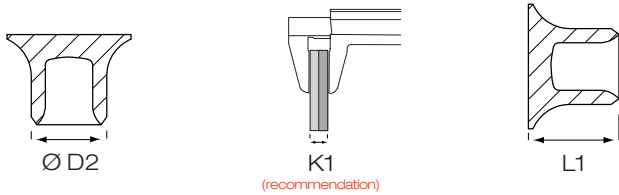

ØD2	3.3 mm				5.3 mm							
material	steel				steel							
L1 (mm)	3.5	4.5	5.0	6.0	4.0	5.0	6.0	6.5	7.0	7.5	8.0	9.0
K1 (mm)	1.5-2.5	2.5-3.5	3.0-4.0	4.0-5.0	2.0-3.0	3.0-4.0	4.0-5.0	4.5-5.5	5.0-6.0	5.5-6.5	6.0-7.0	7.0-8.0
item N°	777218	777200	777225	777222	777202	777219	777221	777224	777226	777223	777201	777199
sales unit	100 pcs.	100 pcs.	100 pcs.	100 pcs.	200 pcs.	100 pcs.	100 pcs.	100 pcs.	100 pcs.	100 pcs.	100 pcs.	100 pcs.

**Flow-form rivets (10pcs.)**

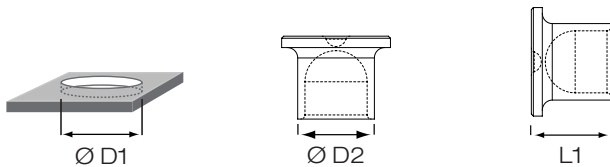

ØD1	6.0 mm									
ØD2	5.6 mm									
material	steel							aluminium		
L1 (mm)	6.9	8.1	9.3	10.6	12.6	13.8	15.0	8.1	9.3	10.6
name	S0	S1	S2	S3	S4	S5	S6	A1	A2	A3
item N°	777232	777212	777213	777214	777233	777234	777235	777209	777210	777211

ØD1	8.0 mm						
ØD2	7.4 mm						
material	steel						
L1 (mm)	8.0	9.2	10.4	11.4	12.6	13.8	15.0
name	S08	S18	S28	S38	S48	S58	S68
item N°	777260	777261	777262	777263	777264	777265	777266

**Countersunk flow-form rivets (10pcs.)**

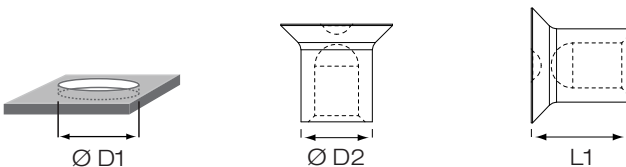

ØD1	6.0 mm						
ØD2	5.7 mm						
material	steel						
L1 (mm)	5.8	7.8	9.0	10.1	11.5	12.9	13.9
name	CS0	CS1	CS2	CS3	CS4	CS5	CS6
item N°	777304	777300	777301	777302	777303	777305	777306



## RivBox N° 1 - assortment box standard

item N° 777281

scope of delivery:

### self-piercing rivets:

100 x 3.3 x 3.5 mm  
 100 x 3.3 x 4.0 mm  
 200 x 5.3 x 4.0 mm  
 100 x 5.3 x 5.0 mm  
 100 x 5.3 x 6.0 mm

### flow-form rivets:

20 x ALU 5.6 x 8.1 mm	A1
10 x ALU 5.6 x 9.3 mm	A2
10 x ALU 5.6 x 10.6 mm	A3
10 x steel 5.6 x 8.1 mm	S1
10 x steel 5.6 x 9.3 mm	S2
10 x steel 5.6 x 10.6 mm	S3

### blind rivets:

40 x ALU 5.0 x 6.0 mm  
 40 x ALU 6.0 x 8.0 mm  
 20 x BMW 4.0 x 10.0 mm  
 20 x BMW 4.0 x 12.0 mm  
 20 x RIBE 6.5 x 12.5 mm

### blind rivet nuts:

25 x steel M6 x 9.0 x 15.5 mm  
 10 x steel M8 x 11.0 x 17.0 mm  
 5 x steel M12 x 15.9 x 23.0 mm

### 1 x Special Center Punch

with 2 functions for self-piercing rivets



## RivBox N° 2 - assortment box flow-form rivets

item N° 777282

scope of delivery:

### flow-form rivets:

10 x FFN / FFR ALU 5.6 x 8.1 mm	A1
10 x FFN / FFR ALU 5.6 x 9.3 mm	A2
10 x FFN / FFR ALU 5.6 x 10.6 mm	A3
10 x FFN / FFR steel 5.6 x 8.1 mm	S1
10 x FFN / FFR steel 5.6 x 9.3 mm	S2
10 x FFN / FFR steel 5.6 x 10.6 mm	S3
10 x FFN / FFR steel 5.6 x 12.6 mm	S4
10 x FFN / FFR steel 5.6 x 13.8 mm	S5
10 x FFN / FFR steel 5.6 x 15.0 mm	S6
10 x FFN / FFR steel 7.4 x 8.0 mm	S08
10 x FFN / FFR steel 7.4 x 9.2 mm	S18
10 x FFN / FFR steel 7.4 x 10.4 mm	S28
10 x FFN / FFR steel 7.4 x 11.4 mm	S38
10 x FFN / FFR steel 7.4 x 12.6 mm	S48
10 x FFN / FFR steel 7.4 x 13.8 mm	S58
10 x FFN / FFR steel 7.4 x 15.0 mm	S68



## RivBox N° 3 - assortment box

item N° 777283

scope of delivery:

### countersunk flow-form rivets:

50 x SFFN / CFFR CF0  
 50 x SFFN / CFFR CF1  
 50 x SFFN / CFFR CF2  
 50 x SFFN / CFFR CF3  
 50 x SFFN / CFFR CF4

### flow-form rivets:

50 x FFN / FFR S0  
 50 x FFN / FFR S1  
 50 x FFN / FFR S2  
 50 x FFN / FFR S3  
 50 x FFN / FFR S4

### 1 x Special Center Punch

with 2 functions for self-piercing rivets



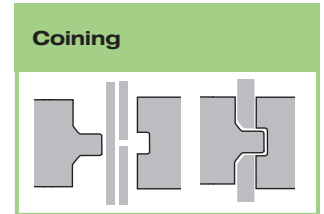
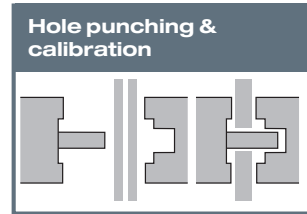
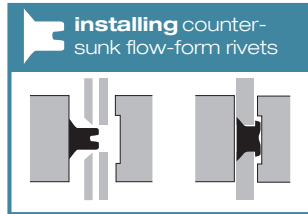
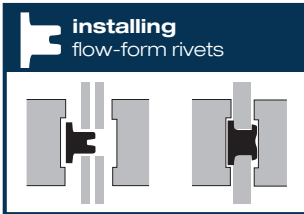
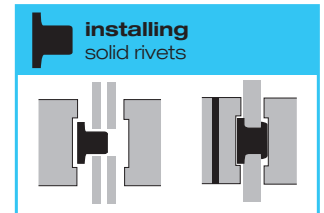
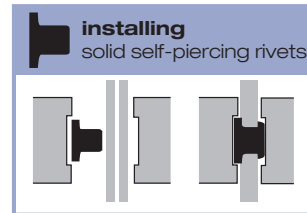
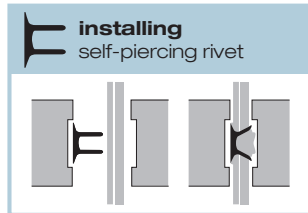
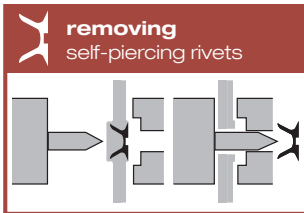

application videos



## Tool Box RS-03 for SSC 35/25 / SSC 40/25

item N° 700200

A1	A2	D1	D2	E1	E2
x1	x1	x1	x1	x1	x1
Ø 5.2 mm		Ø 3 mm		Ø 5 mm	

inclusive:

**F1**  
**Z4**



## Tool Box RS-05 for SSC 35/25 / SSC 40/25

item N° 700202

D3	D4	D13	D14	D18	D19	S1	S4	S5	D5
x1	x1	x1	x1	x1	x1	x1	x1	x1	x1
Ø 5 mm		Ø 5.3x7.5 mm			Ø 3.2 mm				5 mm

inclusive:

**F1**  
**Z4**

D12	D10	D11	D6	D7	D15	D16	D8	D9	D17
x1	x1	x1	x1	x1	x1	x1	x2	x1	x2
5 mm	Ø 4 mm		Ø 4.8 mm		Ø 6 mm		Ø 4 mm		6 mm

S2	S3	S6	S7	S8
x1	x1	x1	x1	x1
Ø 3.2 mm			Ø 5.3 mm	



## Tool Box RS-06 for SSC 35/25 | SSC 40/25

item N° 700193

A4	A6	BL6	C1	C2	C16	C17	C18	C21	E3
x1	x1	x1	x1	x1	x1	x1	x1	x1	x1
Ø 9 mm		6 mm	Ø 6 mm		6 mm		Ø 4.7 mm		

inclusive:

**F1**  
**Z4** SKR 6 mm

J1	K1	K2	K5
x2	x1	x1	x1
6 mm	Ø 6 mm		6 mm



## Tool Box RS-07 for PushPull PP 90

item N° 700205

V1	V2	B3	B4	B7	G1	B5	B6	B8	G2
x1	x1	x1	x1	x1	x1	x1	x2	x1	x1
Ø 4 mm			Ø 6 mm				Ø 8 mm		

inclusive:

**F3**  
**Z1**  
**Z4** SKR 6 mm  
SKR 8 mm

C1	C2	C3	C4	C5	K1	K2	K3	K4	A4
x1	x1	x1	x1	x1	x1	x1	x1	x1	x1
Ø 6 mm		Ø 8 mm		8 mm	Ø 6 mm		Ø 8 mm		





## Tool Box RS-08 for SSC 35/25 | SSC 40/25 | PushPull PP 90

item N° 700206

A4	B5	B6	B8	G2	C3	C4	C5	K3	K4
x1	x1	x1	x1	x1	x1	x1	x1	x1	x1
Ø 8 mm				Ø 8 mm			Ø 8 mm		

E1
x1
5.3mm

inclusive:

F1	
F3	
F5	
Z1 Z4	



## Tool Box RS-09 for SSC 35/25 | SSC 40/25

item N° 700195

A4	BL8	C10	C11	C12	C13	C14	C15	C19	C20
x1	x1	x1	x1	x1	x1	x1	x1	x1	x1
Ø 6 mm									

inclusive:

F1
Z4



## Tool Box RS-10 for PushPull PP 90

item N° 700208

A4	B6	C1	C2	C16	K5	B3	B4	B7	G1
x2	x1	x1	x1	x1	x1	x1	x2	x1	x1
Ø 8 mm		Ø 6 mm			6 mm	Ø 6 mm			

K1	K2
x2	x2
Ø 6 mm	

inclusive:

F3	
Z1	
Z4	



## Tool Box RS-11 for SSC 35/25 | SSC 40/25

item N° 700209

E1	T1	T2	T3	T4	T5	T6	T7	T8
x1	x1	x1	x1	x1	x1	x1	x1	x1
Ø 5 mm								

inclusive:

F1
Z4



## Tool Box RS-12 for PushPull PP 90

item N° 700210

A5	B6	B3	B4	B7	G1	C1	C2	C16	K5
x1	x1	x1	x1	x1	x1	x1	x1	x1	x1
Ø 8 mm		Ø 6 mm			Ø 6 mm		6 mm	6 mm	

E1	E2	K1	K2
x1	x1	x1	x1
Ø 5 mm		Ø 6 mm	

inclusive:

F3	
Z1	
Z4	
	
	



## Tool Box RS-13 Porsche for SSC 35/25 | SSC 40/25

item N° 700196

A4	BL6	BL8	C1	C16	K1	K2
x1	x1	x1	x1	x1	x1	x1
6 mm		8 mm	Ø 6 mm		Ø 6 mm	

inclusive:

F1	
Z4	



## Tool Box RS-14 PushPull

item N° 700212 self-piercing rivets add-on set

D1	D2	E1	E2
x1	x1	x1	x1
3 mm		5 mm	

inclusive:

F4
Z4



## Tool Box Punch Kit











item N° 700143 for PushPull PP 90











K1	B67
x1	x1
Ø 6.7 mm	











inclusive:

	SKR 6.7 mm
---	---------------

















						4.7 mm	4.7 mm		
									
<b>C10</b>	<b>C11</b>	<b>C12</b>	<b>C13</b>	<b>C14</b>	<b>C15</b>	<b>C17</b>	<b>C18</b>	<b>C19</b>	<b>C20</b>
700537	700538	700541	700542	700539	700540	700891	703051	703226	703224

4.7 mm	3 mm	3 mm	5 mm	5 mm	4.7 mm	3.2 mm	3.2 mm	5.3 mm	5.3x5.5 mm
									
<b>C21</b>	<b>D1</b>	<b>D2</b>	<b>E1</b>	<b>E2</b>	<b>E3</b>	<b>S2</b>	<b>S3</b>	<b>S6</b>	<b>S7</b>
703232	700332	700262	700260	700261	700336	700233	700822	700236	700824

5.3x6.5 mm	5 mm	5 mm	5 mm	5 mm	5 mm	5 mm	5 mm	5 mm	4 mm
									
<b>S8</b>	<b>T1</b>	<b>T2</b>	<b>T3</b>	<b>T4</b>	<b>T5</b>	<b>T6</b>	<b>T7</b>	<b>T8</b>	<b>D8</b>
700823	700360	700366	700361	700362	700363	700364	700365	700367	700813

4 mm	6 mm	6 mm	6 mm	6 mm	6 mm	8 mm	8 mm	8 mm	4 mm
									
<b>D9</b>	<b>D17</b>	<b>J1</b>	<b>C16</b>	<b>C1</b>	<b>C2</b>	<b>C3</b>	<b>C4</b>	<b>C5</b>	<b>V1</b>
700811	700810	700248	700448	700256	700257	700266	700267	700276	700333

4 mm	5.2 mm	5.2 mm			9 mm	6 mm	8 mm	3.2-5.0 mm	5 mm
									
<b>V2</b>	<b>A1</b>	<b>A2</b>	<b>A4</b>	<b>A5</b>	<b>A6</b>	<b>BL6</b>	<b>BL8</b>	<b>D3</b>	<b>D4</b>
700277	700250	700251	700341	700369	700895	703222	703221	700800	700799

5.3x7.5 mm	5.3x7.5 mm	3.2 mm	3.2 mm	3.2 mm	5.3x5.5 mm	5.3x6.5 mm	6 mm	8 mm	5 mm
									
<b>D13</b>	<b>D14</b>	<b>D18</b>	<b>D19</b>	<b>S1</b>	<b>S4</b>	<b>S5</b>	<b>B4</b>	<b>B6</b>	<b>D5</b>
700812	700808	700804	700806	700795	700796	700798	700264	700270	700816

6 mm	6 mm	8 mm	6 mm	8 mm	6.7 mm	8 mm	6 mm	8 mm	4 mm
									
<b>K5</b>	<b>B3</b>	<b>B5</b>	<b>B7</b>	<b>B8</b>	<b>B67</b>	<b>D12</b>	<b>G1</b>	<b>G2</b>	<b>D10</b>
700449	700343	700344	700345	700342	700386	700820	700273	700268	700814

4 mm	4.8 mm	4.8 mm	6 mm	6 mm	6 mm	6 mm	8 mm	8 mm
								
<b>D11</b>	<b>D6</b>	<b>D7</b>	<b>D15</b>	<b>D16</b>	<b>K1</b>	<b>K2</b>	<b>K3</b>	<b>K4</b>
700827	700815	700806	700826	700809	700319	700297	700318	700298

32 mm extension **F1**

item N° 700220

for all riveting processes in combination with the **short-stroke cylinder SSC 35/25** **short-stroke cylinder SSC 40/25**



26 mm extension **F3**

item N° 700337

for all riveting processes in combination with the **PushPull Zylinder PP90**



28 mm extension **F4**

item N° 700442

for all riveting processes in combination with the **Tool Box RS-14**



28 mm **adapter Böllhof F5**

item N° 700443

for all riveting processes in combination with the **Böllhof dies**



assembling tool **Z4**

item N° 700299



coupling **PushPull Z1**

item N° 700280

A coupling used to connect the punching dies **B3**, **B5**, **B7** and **B8** to the PushPull cylinder.



**Special Center Punch with 2 functions**

item N° 628006

Function no 1: to mark the rivets at the top side of the rivet  
Function no 2: to mark the rivets at the bottom side of the rivet  
**The special center punch is self-centering.**





[www.wielanderschill.com](http://www.wielanderschill.com)



<https://www.wielanderschill.com/agb>

Lieferung ab Werk. Alle Preise zzgl. MwSt. Es gelten unsere AGB.  
Druckfehler, Irrtümer und Änderungen vorbehalten.  
Misprints, mistakes and alterations are reserved.

WS Wieländer+Schill GmbH & Co. KG  
Professionelle Karosserie-Spezialwerkzeuge  
Neue Wiesen 8  
D-78609 Tuningen

Kontakt / Contact

Tel. +49 (0)7464 9898 0  
Fax +49 (0)7464 9898 289

[info@wielanderschill.com](mailto:info@wielanderschill.com)