

Rev.01



REF.: MCL007

ASSEMBLY INSTRUCTIONS:

- 1- PLEASE READ THESE INSTRUCTIONS COMPLETELY BEFORE STARTING ASSEMBLY;
- 2- THE ASSEMBLY MUST BE EXECUTED ON A FLAT AND CLEAN SURFACE;
- 3- FOR CLEANING PLEASE USE A WATER SEMI WET CLEAN CLOTH FOLLOWING BY A DRY CLEAN CLOTH;
- 4- DO NOT USE ABRASIVES SOLUTIONS;

ASSEMBLY INSTRUCTIONS
MEDIUM DRAWER FOR CLOSET

PART LIST		
PART NUMBER	QTY	DESCRIPTION:
1	2	DRAWER SIDE PANEL
2	1	DRAWER BACK PANEL
3	1	DRAWER INSIDE FRONT
4	1	DRAWER BOTTOM PANEL
5	1	DRAWER FRONT

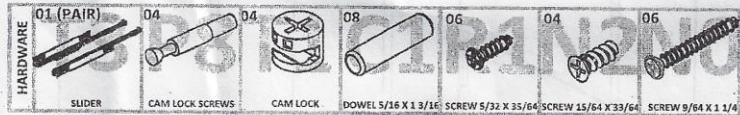
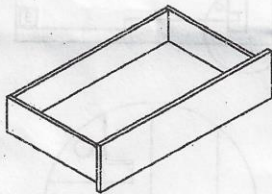
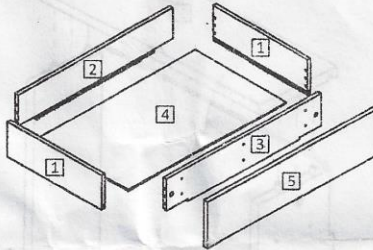

STEP 01
PREPARATION OF DRAWER SIDE PANELS

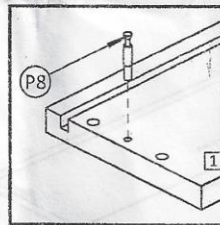
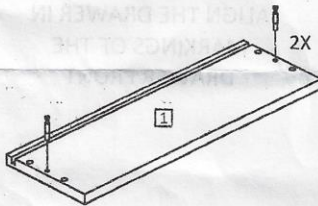

STEP 02
DRAWER ASSEMBLY

STEP 02
PREPARATION OF DRAWER BACK PANEL AND DRAWER INSIDE FRONT

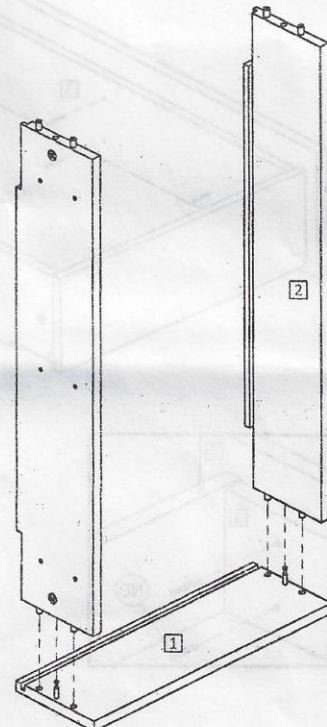
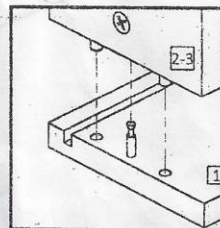
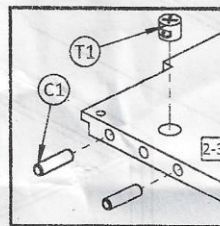
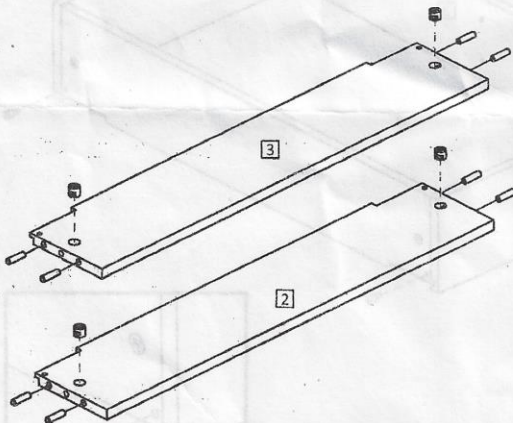

We recommend 1.25" - 1.5" between two drawer front panels.

STEP 04
BACK PANEL ASSEMBLY

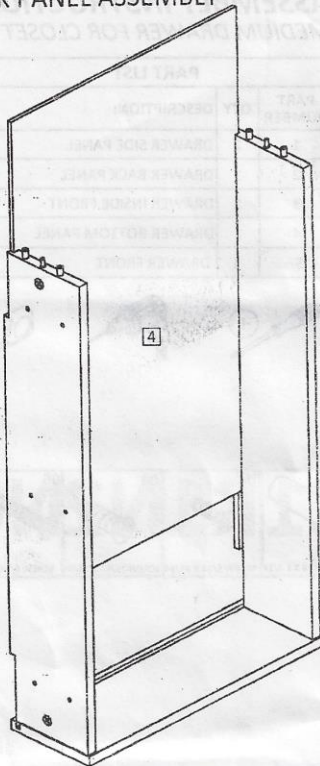

STEP 05
RIGHT SIDE PANEL ASSEMBLY

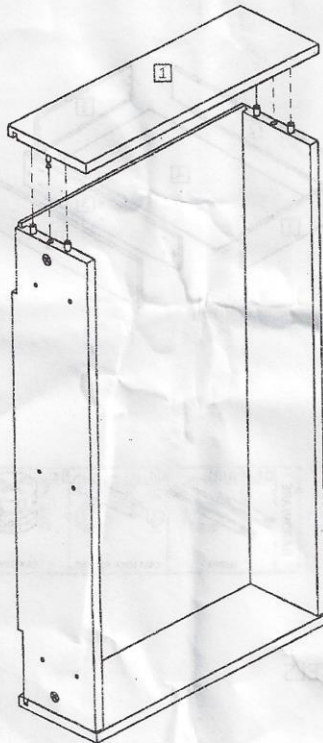

Rev.01



REF.: MCL007

ASSEMBLY INSTRUCTIONS
MEDIUM DRAWER FOR CLOSET

DRAWER BACK VIEW

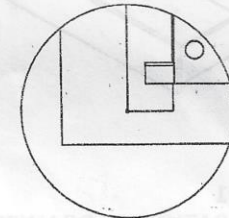
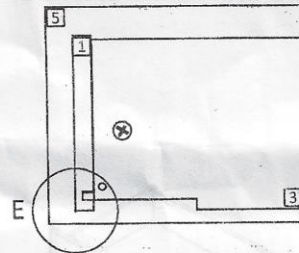

DETAIL E
ALIGN THE DRAWER IN
MARKINGS OF THE
DRAWER FRONT

STEP 06
DRAWER FRONT ASSEMBLY

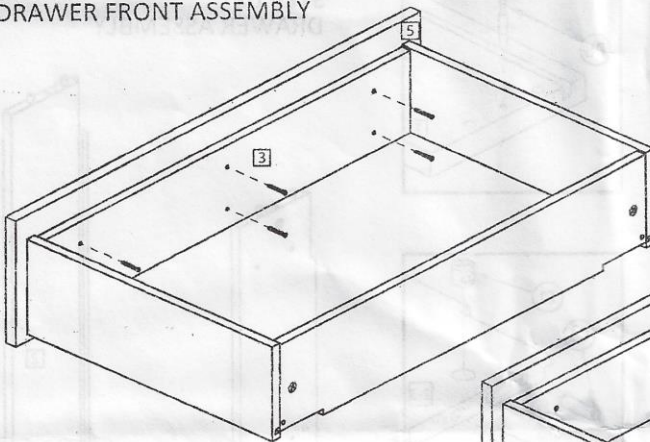

STEP 07
PIN DRAWER ASSEMBLY

