

# KOPFJÄGER

## K700 AMT TRIPOD



3-POSITION  
ANGLE LOCKS



DURABLE FOAM  
SOFT GRIPS



UP TO 72 INCHES EXTEN  
UNDER 27 INCHES FOLD



HEAVY DUTY  
LEG LOCK LEVERS



REVERSIBLE  
CENTER COLUMN



UP TO 25  
LBS  
LOAD WEIGHT



USER MANUAL

KJ85001

## HEAVY DUTY K700 TRIPOD

When the stakes are high, shooters require no compromise. The Heavy Duty K700 tripod meets the demanding needs of LEO, military personnel, hunters and precision shooters. From prone to standing, the K700 features adjustable 3-level angle locks and 2-level leg extensions with locking levers providing rifle stability and comfort in almost any shooting position. The reversible center column allows you to adjust the height of your firearm or camera by an extra 14.9 inches. Crafted of sturdy aluminum, K700 features sure-grip foam panels, rubber grip feet and holds up to 25 lbs. Fully extracted, the tripod measures 72 inches and fully retracted, 27 inches. The Heavy Duty TK700 includes a tripod case and 3/8"-16 (1/4"-20) reversible threaded stud.

### SPECIFICATIONS

Maximum operating height (in/mm)	72 / 1829
Minimum operating height (in/mm)	10.75 / 273
Maximum center column extension (in/mm)	14.9 / 380
Folded length	27 / 686
Material	Aluminum
Weight (lbs/g)	5.5 / 2510
Number of leg sections	3
Maximum load	25 lbs
Leg lock type	Lever lock

### INCLUDES:

- Carrying case
- Allen key

## DIAGRAM

1. Center column
2. Center column locking collar
3. Center column stopper
4. Center column base stopper
5. Rubber leg tip
6. 3-position leg angle adjustment lock
7. Soft grip
8. Leg
9. Leg lock
10. Leg lock lever

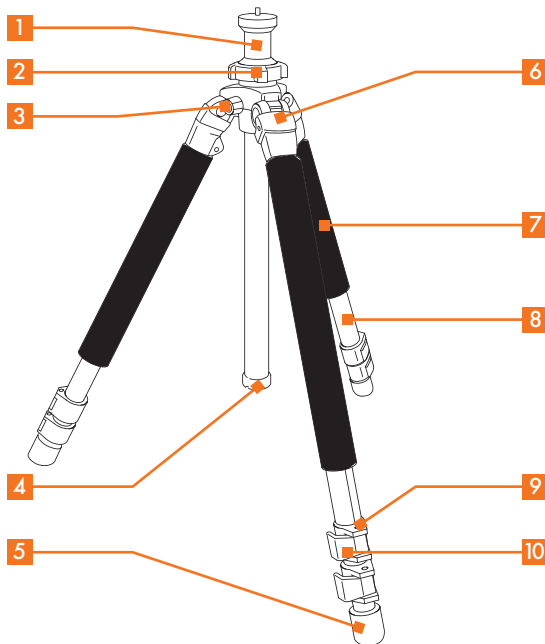

## OPENING THE TRIPOD LEGS

Be sure to open all three legs completely in order to prevent camera shake or accidental tip overs caused by instability. To open the legs, pull the angle adjustment lock out.



## ADJUSTING LEG ANGLE

1. To change the angle of each leg, close the leg slightly and then pull the angle adjustment lock out. (Three total adjustments)
2. After choosing the desired leg angle, securely push in the adjustment lock.

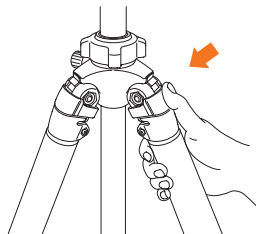
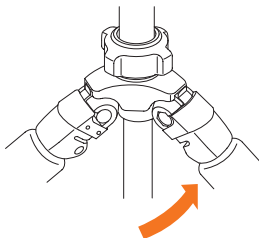
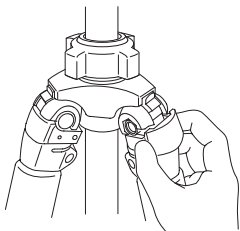

## EXTENDING TRIPOD LEGS

1. Flip up the leg lock lever and extend or shorten each individual leg to the desired height.
2. Press the leg lock lever to lock in position.



## HOW TO USE PRONE OR SITTING

1. Remove the center column base stopper, then remove the lower part of the center column.
2. Put the center column base stopper on the upper part of the center column.
3. Insert the center column from the lower side of the main body and tighten the center column stopper.
4. Make sure to re-attach the center column base stopper in order to prevent the center column from falling out accidentally.

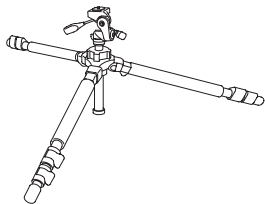

## USING THE CENTER COLUMN

1. Hold onto the pan head with one hand and loosen the center column stopper and center column locking collar with other hand.
2. Next, raise or lower pan head to desired height.
3. While maintaining a hold of the pan head, tighten the locking collar and stopper.

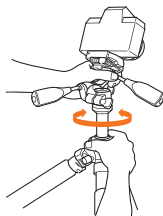
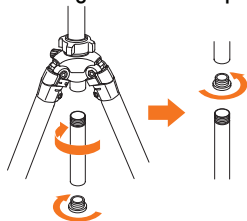

**CAUTION** – You may injure your hand if you let go of the pan head before locking it in place.  
To avoid unnecessary camera or rifle movement, try to keep the center column height to a minimum.

## INVERTING THE CENTER COLUMN

1. Always remove the pan head before inverting center column.
2. Remove the center column base stopper turning it clockwise.
3. Loosen the center column stopper and the locking collar, then pull out the center column.

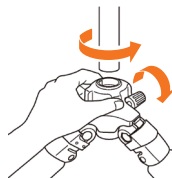
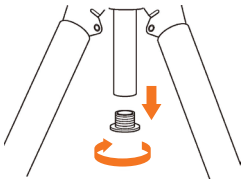
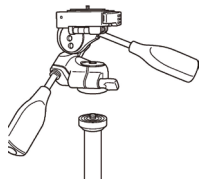

4. Insert the center column from the lower side of the main body and tighten the locking collar and the center base column base stopper.
5. Make sure to re-attach the center column base stopper.
6. By inverting the center column, it is possible to do close-ups.

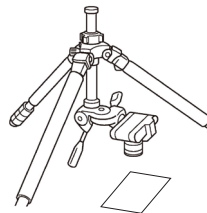
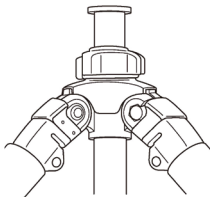
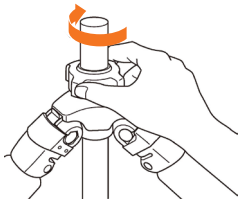

## CHANGING THE PAN HEAD FIXED SCREW

The pan head fixed screw is reversible for either large thread (3/8") or small thread(1/4").

1. Move the plate cover down.
2. Loosen the small screw in about three turns with an Allen wrench (2.5mm width.)
3. Loosen the plate without removing the small screw.
4. Loosen the pan head fixing screw and pull it out. Then, screw it in again after reversing the top and bottom.
5. Adjust the height of the screw in approx. 8mm above the plate and then tighten the small screw with an Allen wrench.
6. Put the plate cover back.

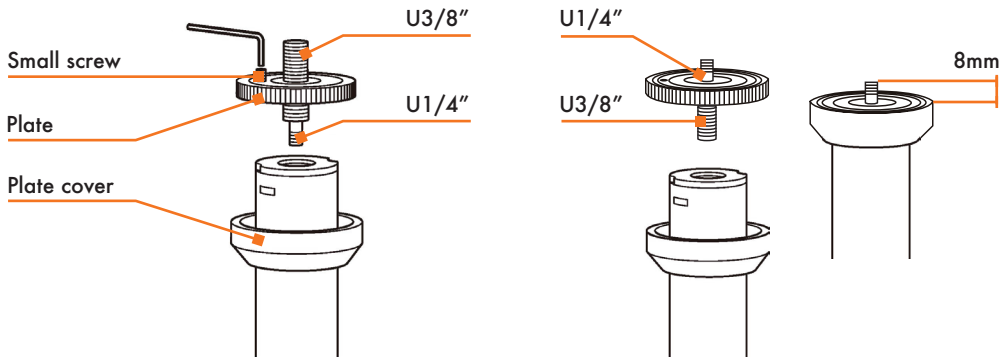



## REPLACEMENT PARTS

If your tripod's feet begin to wear down, then simply visit [kjrest.com](http://kjrest.com) to purchase replacement feet. Easily slide off old feet and replace with the new ones.

## MAINTENANCE

- DO NOT apply any grease or oil anywhere on this tripod.
- Clean with a mild detergent and a soft cloth only.
- Avoid extreme heat and do not use close to a flame.

## WARNING

Before handling the tripod, read and understand the contents of the manual. Follow all standard safety precautions and procedures during use.

- Never leave a loaded firearm on the tripod without having positive physical control over the shooting system.
- Do not exceed the tripod's maximum load capacity.
- Ensure all accessories are fastened.
- Always remove camera, spotting scopes and other accessories during setup or transport.

## WARRANTY

Please visit [www.kjrest.com](http://www.kjrest.com) for warranty details and information.

## NOTES

---

---

---

---

---

---

---

---

---

---



---

---

---

---

---

---

---

---

---

---



[www.kjrest.com](http://www.kjrest.com)