

Pira G2 planning guide

White/white oak, floor-ceiling mounted.
Height 257 cm. Width 70 + 70 + 90 cm.





DESIGN ANNA VON SCHEWEN AND BJÖRN DAHLSTRÖM,
FROM OLLE PIRA'S CLASSIC.

Olle Pira (1927 - 2018) was an influential Swedish architect and interior designer who designed the original Pira shelf system for the iconic H 55 exhibition in 1955.

The Pira G2 is a contemporary interpretation of the mid-century classic with updated materials and manufacturing, by designers Björn Dahlström and Anna von Schewen. It has an architectural presence due to its frame and size. A distinctly modern and modular design; elegant and strong at the same time, with a visual language that impacts the spatial perception of a room.

The central point in the PIRA G2 design is the pole which makes the floor-to-ceiling tensioned shelf possible. The shelves themselves wrap around the poles to connect, as if they were one piece. It is modular, yet assembled it gives the perception of having been built as one. A seemingly jointless appearance with no beginnings or ends.

The shelf system is manufactured exclusively from high end materials; the shelves are made of lacquered steel sheets and the poles of extruded aluminium which emphasise the solid look; the cabinets and bookends have the options of walnut or white oak, where the wood brings warmth and creates a contrast to the lacquered metal.

White RAL 9016

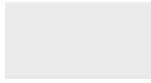

Black grey NCS 8500-N

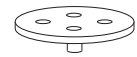

Attachment



Leg

Top lid



Poles

100 cm

91,7 cm

83,3 cm

75 cm

66,7 cm

58,4 cm

50 cm

41,7 cm

33,4 cm

25 cm

16,7 cm

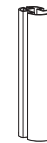
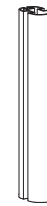
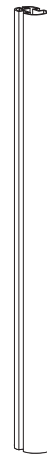
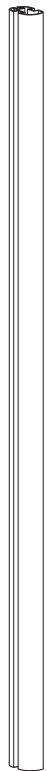

Pole joint



Wall bracket

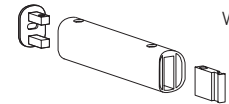

Shelf

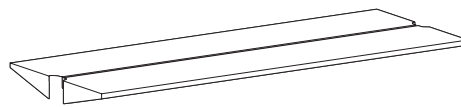
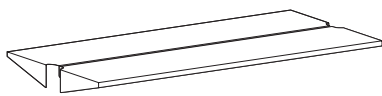

Wing

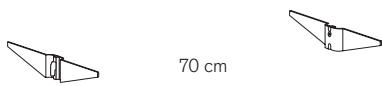

70 cm

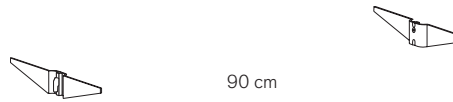

90 cm

Support beam

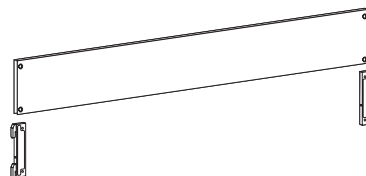
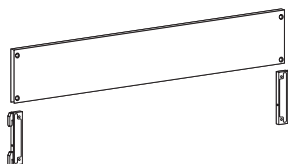

Leg

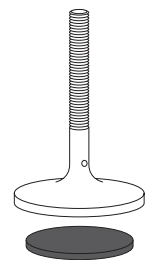

Pad

Assembly kit
Floor-ceiling mounted

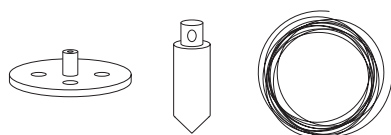

Assembly kit
Wall mounted

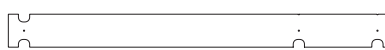

White oak Gloss 5



Walnut Gloss 5

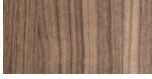

70 cm

90 cm

Organiser

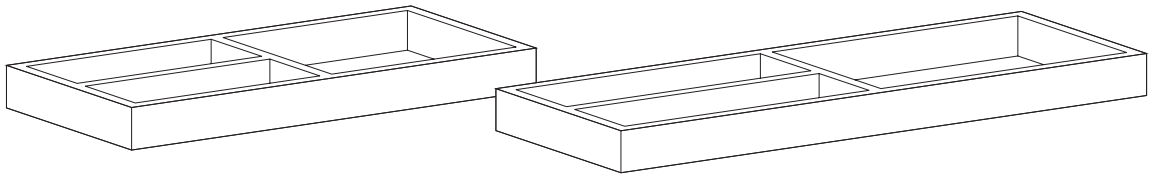

70 cm

90 cm

Cabinet

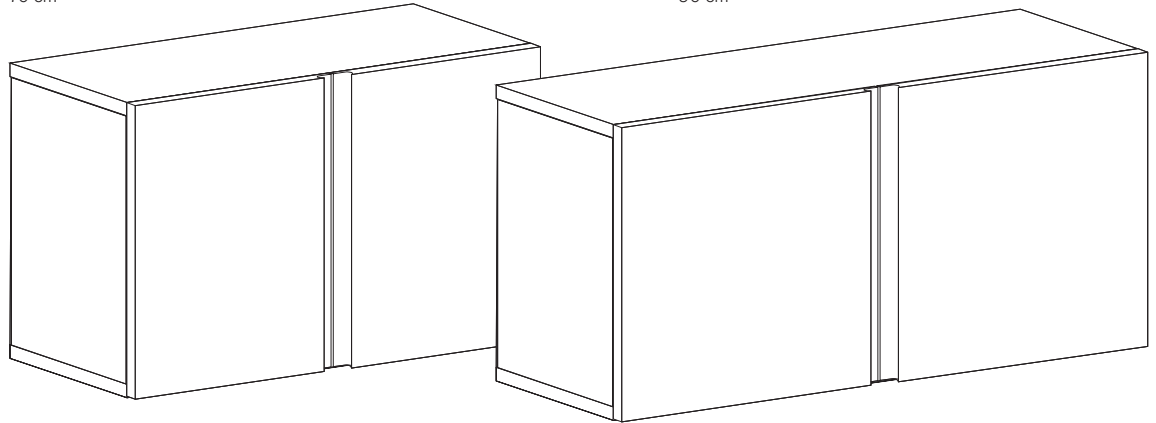

Bookend

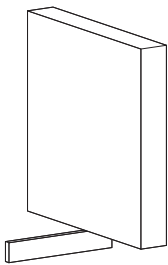

Max height: 308 cm.
Max weight on each shelf: 50 kg.
Max number of shelves in each section: 7.
(Max weight per section 350 kg).

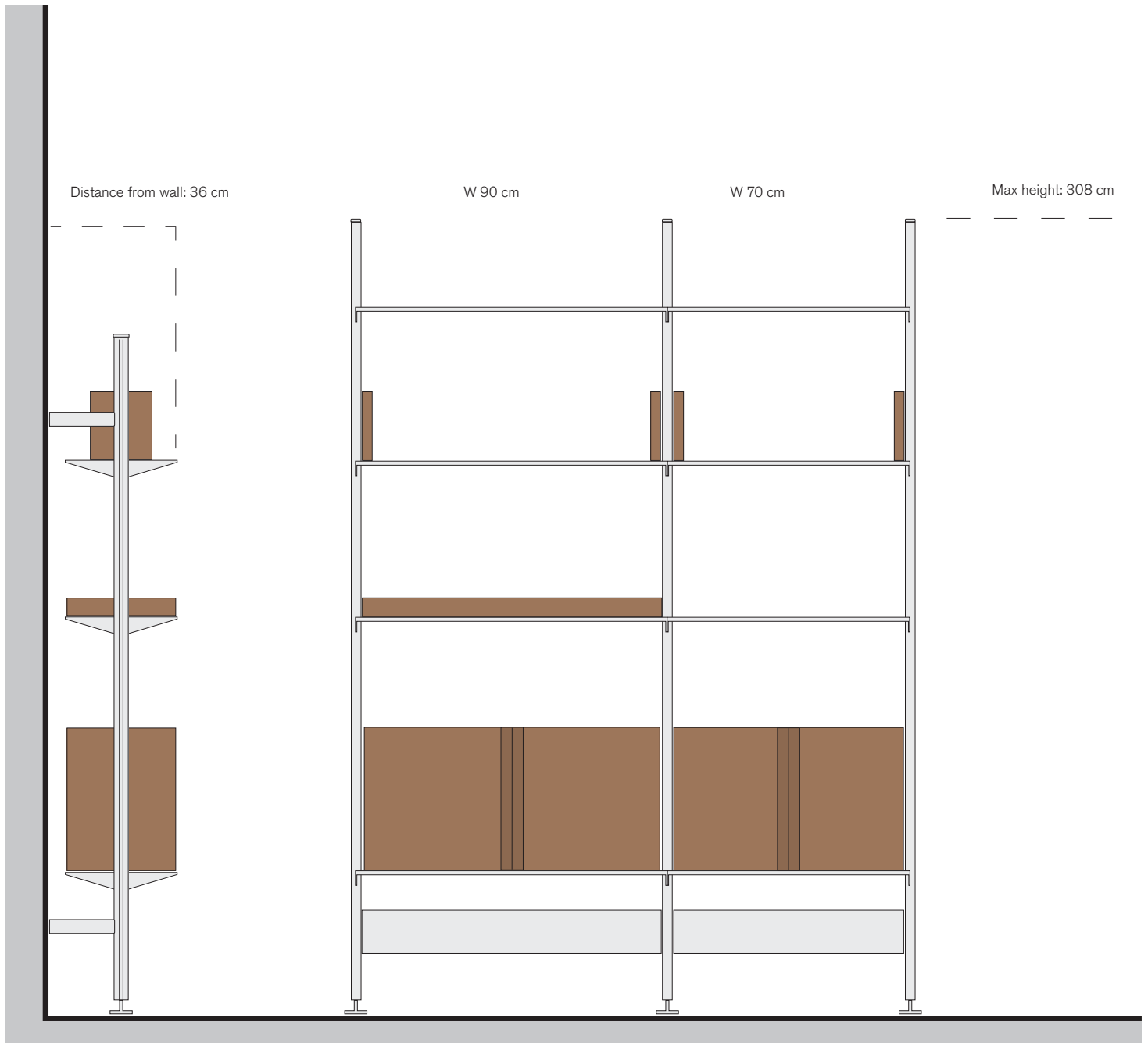

Max height: 316 cm.
Max weight on each shelf: 50 Kg.
Max number of shelves in each section: 7.
(Max weight per section 350 kg).

D 34 cm

W 90 cm

W 70 cm

Max ceiling height 316 cm

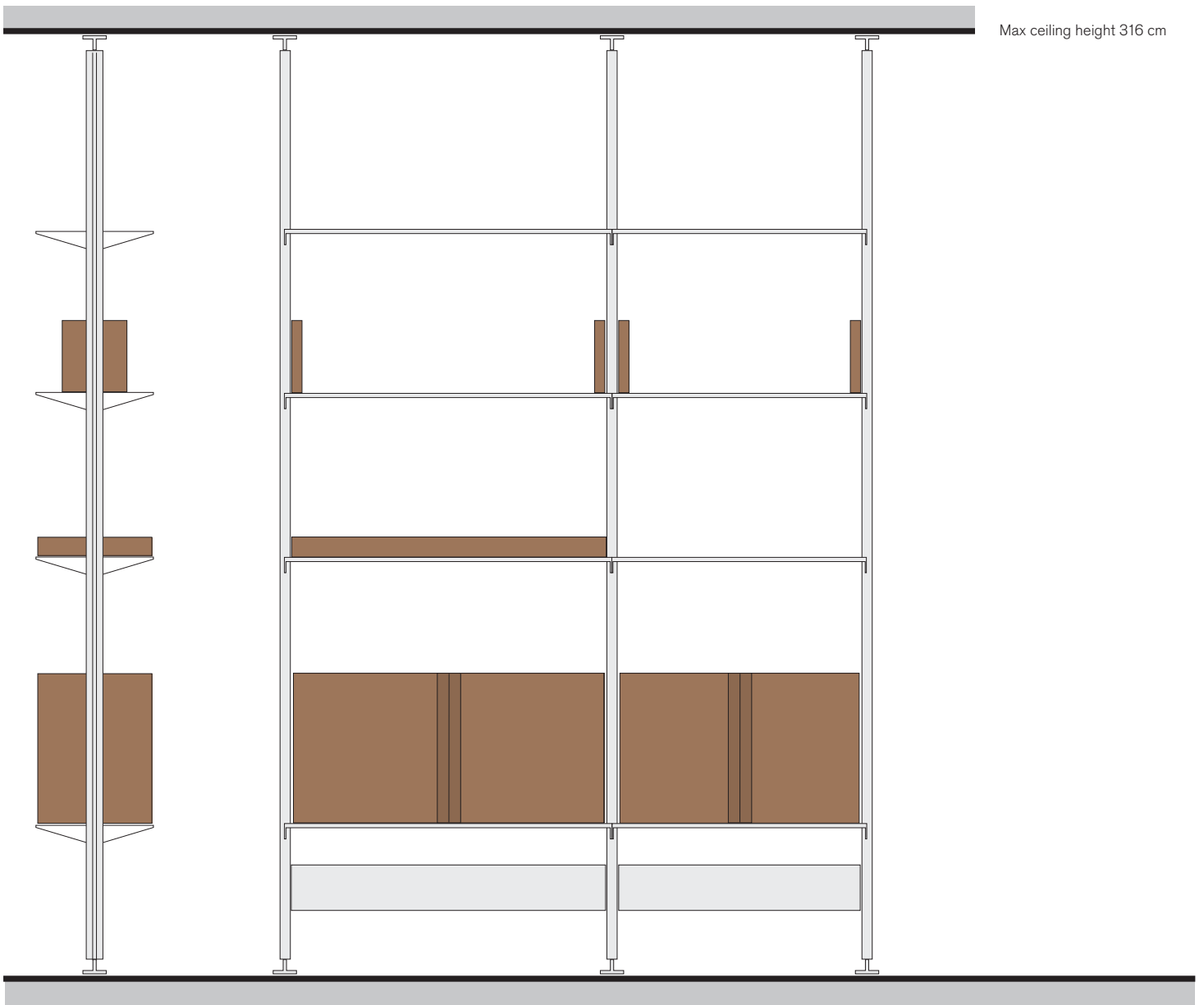

Examples of different ceiling height

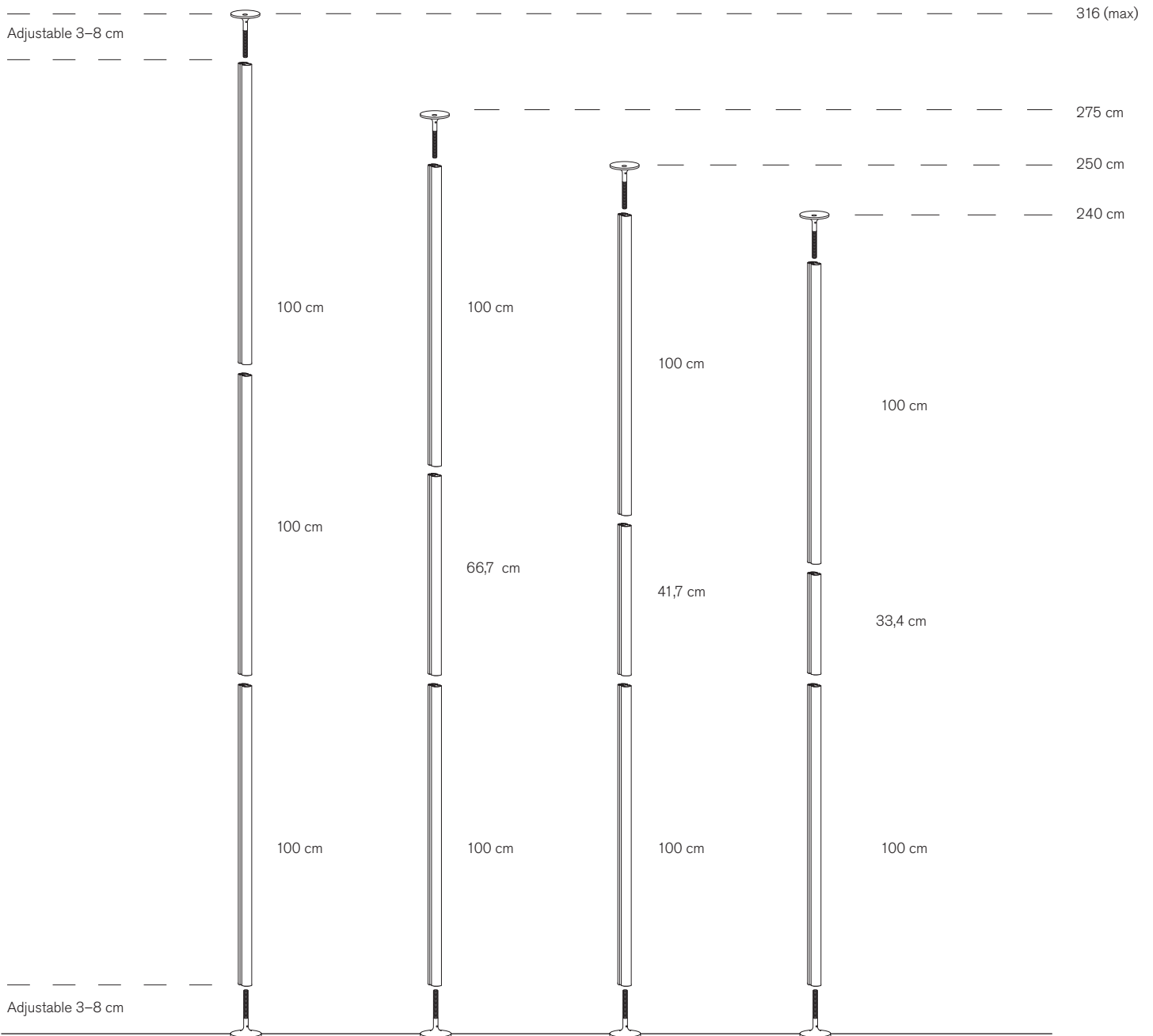

PLAN AND MEASURE YOUR SPACE.

Measure the height and width of your space to determine if the shelf will fit as you planned. Note obstructions that may limit your shelf-type options, such as baseboards and ceiling moldings, stucco and ceiling beams, switches or electrical outlets. (E.g. stucco or ceiling beams may obstruct the shelf's ceiling connection legs when installing a wall-ceiling mounted shelf)

Remember to add 2,35 cm to the side of the shelf for the diameter of the leg when planning an installation near a corner wall. If these measurements are ignored, your shelf may not fit the space as planned. Examine surface layers (wall, floor and ceiling). Do the materials maintain good enough quality for installation?

We cannot take responsibility for the poor conditions of walls, floors or ceilings against which the shelf is mounted.

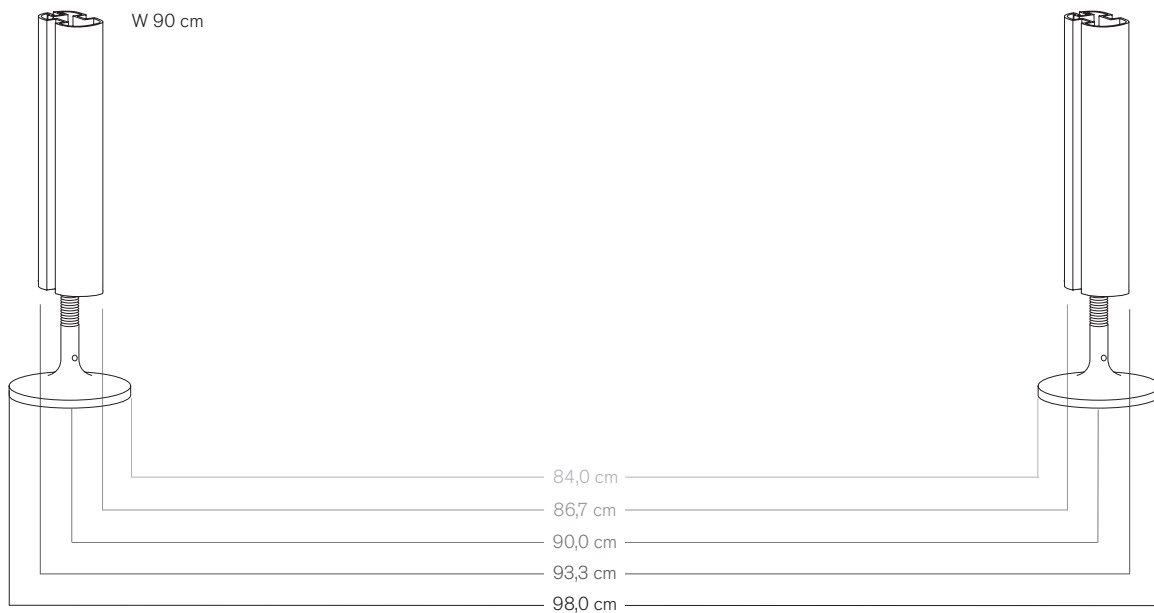
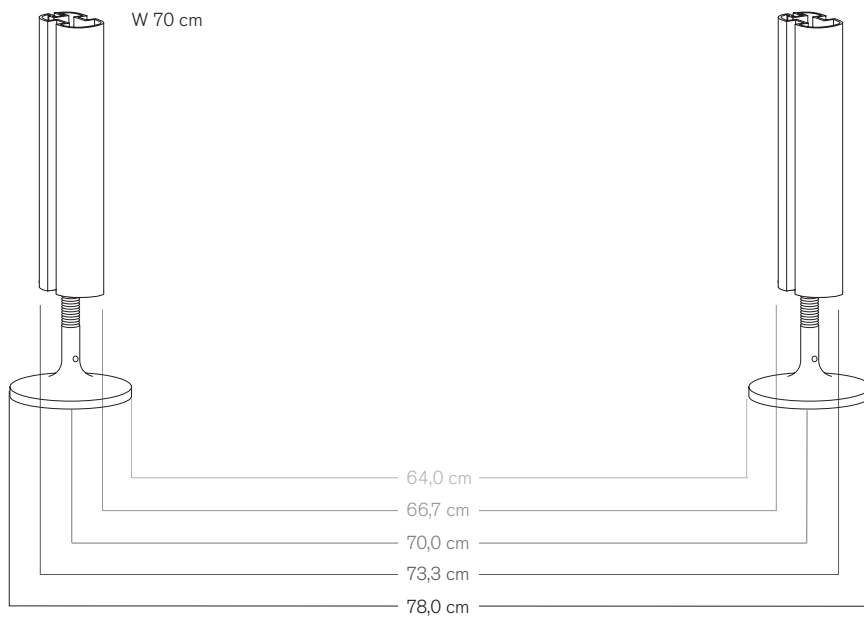

MOUNTING A PIRA G2

The supplied fittings are designed for mounting on high-quality walls, floors and/or ceilings. The screws are designed for installation without plugs in wood-based walls, floors and/or ceilings.

If the walls, floor and/or ceiling are made of plaster, concrete or brick, a plug must be used with the same screw. In the slightest doubt or if the walls, floor and/or ceiling are made of a different material, contact your local specialized dealer for a suitable screw and plug for the installation. If you choose to disregard our advice, we will not be able to accept any responsibility for any subsequent failure or damage to your shelf.

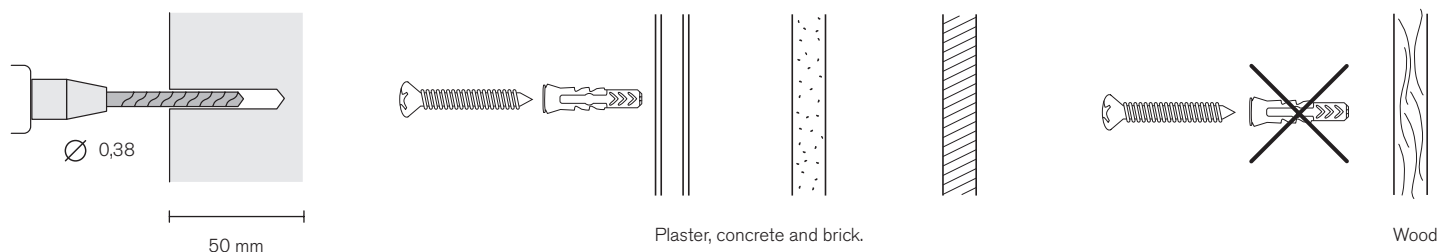

PIRA CALCULATOR

The Pira G2 is modular and is a combination of many main and auxiliary parts. Our calculator simplifies the planning and ensures that your customer have all the right parts, in the right size. Simply enter the height, shelf-type, colour and number of sections you want and the calculator will generate a complete itemised list. Save as PDF to get the shelf's recommended retail price or send the order directly to String Furniture through the shopping cart in The Portal.

<https://portal.stringfurniture.com/pira/calculator>

Black grey/walnut, floor-ceiling mounted.
Height 257 cm. Width 90 + 90 cm.



Black grey/walnut, wall mounted.
Height 200 cm. Width 70 cm.



White/white oak, wall mounted.
Height 200 cm. Width 90 + 90 cm.



CUSTOMER SERVICE

For any questions or queries,
please contact String Furniture
customer service on
+46 (0)40 18 70 01.

stringfurniture.com

≡pira

