



24" HD SMART CARAVAN TV

USER MANUAL



READ CAREFULLY BEFORE USING
RETAIN MANUAL FOR FUTURE REFERENCE

CONTENTS

IMPORTANT INSTRUCTIONS	2
Safety Instructions	2
Battery Handling & Usage	3
Disposal Of Old Electrical Appliances	3
ACCESSORIES	4
FEATURES	4
GENERAL PARTS	5
REMOTE CONTROL	7
REMOTE CONTROL PREPARATION	8
Battery Installation	8
Service Life of Batteries	8
Remote Control Operation	8
BASIC CONNECTION	9
Power Connection	9
Connect External Antenna to Unit	9
LAN Connection	10
Optical Connection	10
Composite CVBS Connection	10
HDMI Connection	11
USB Connection	11
Earphone Connection	11
BASIC OPERATIONS	12
HOME PAGE	16
MAIN MENU	17
Picture	17
Sound	20
Network	21
Channel	23
Accessibility	26
System Settings	27
Support	29
MULTI-SCREEN	31
SMART FUNCTIONS	31
MAINTENANCE	33
WALL MOUNTING	33
STAND INSTALLATION	34
SPECIFICATIONS	35
TROUBLESHOOTING	34
WARRANTY	35



Read this installation instruction thoroughly.
 Incorrect installation or operation may void any warranty.
 Incorrect use or operation may cause serious injury.

IMPORTANT INSTRUCTIONS

SAFETY INSTRUCTIONS

HAZARD SIGNAL	DEFINITION
	The lightning flash and arrowhead within the triangle is a warning sign alerting you of “dangerous voltage” inside the product.
	CAUTION: TO REDUCE THE RISK OF ELECTRIC SHOCK. DO NOT REMOVE COVER (OR BACK). NO USER SERVICEABLE PARTS INSIDE. REFER SERVICING TO QUALIFIED SERVICE PERSONNEL.
	The exclamation point within the triangle is a warning sign alerting you of important instructions accompanying the product.

⚠ WARNING: To reduce the risk of fire, electric shock, or serious personal injury:

- If the cord is damaged, have it repaired by the manufacturer, its service or a similarly qualified person to avoid any hazard.
- The cord should always be readily accessible.
- The apparatus should not be exposed to dripping or splashing of water or liquids and that no objects filled with liquids such as flowers vases shall be placed on the product.
- The normal ventilation of the product should not be impeded for intended use.
- Always leave a minimum distance of 10 cm around the unit to ensure sufficient ventilation.
- Naked flame sources, such as candles, should not be placed on top of the device.
- The device is intended for use only in a temperate climate.
- Situate this product away from heat sources such as radiators, heat registers, stoves, or other appliances (including amplifiers) that produce heat.
- Clean the product only as recommended by the manufacturer (see “Maintenance” section for details). Unplug the power plug from the wall outlet before cleaning,
- Unplug the power plug from the wall outlet when left unused for an extended period.
- Prevent objects/liquids from falling or spilled on the product.
- Operate the product only with the supplied power cord. Route power cords so they are not likely to be walked on or pinched by items placed upon or against them, paying particular attention to plugs, convenience receptacles, and the point where they exit from the product.
- Where the MAINS plug or an appliance coupler is used as the disconnect device, the disconnect device should remain readily operable.
- Do not operate this product under the following conditions:
 - When the power-supply cord or plug is damaged.
 - If liquid has been spilled into or objects have fallen into the product.
 - If the product has been exposed to rain or water.
 - If the product does not operate when used according to the operating instructions.
 - If the product has been dropped or damaged in any way.
- Do not attempt to service the product; take it to the electronics repair shop of your choice for any servicing or repair.
- Do not overload wall outlets, extension cords, or integral convenience receptacles.
- Connect this product to the power outlet which has protective earth connection.

1300 663 868 | enquiries@aussietraveller.com.au | aussietraveller.com.au

BRISBANE SHOWROOM: 11-15 Oasis Court, Clontarf QLD 4019 | MELBOURNE SHOWROOM: 235 Barry Road, Campbellfield VIC 3061

IMPORTANT INSTRUCTIONS (cont.)

⚠ CAUTION: To reduce the risk of personal injury or product/property damage:

- This product is intended solely for non-commercial, non-industrial, personal use as a television. Do not use this product for any other purpose.
- Ensure product is not subjected to violent shocks, extreme temperatures, or lengthy periods of direct sunlight.
- Keep the product away from magnetic objects, motors, and transformers.
- Do not use outdoors in inclement weather.
- Do not use the TV while driving; this is dangerous and is illegal in some areas.

BATTERY HANDLING & USAGE:

- **CAUTION:** Danger of explosion if battery is incorrectly replaced or not replaced by the same type or equivalent.
- The battery should not be exposed to excessive heat such as sunshine, fire or similar.
- Different types of batteries, new and used batteries should not be mixed.
- The battery must be installed according to the polarity.
- If the battery is worn, it must be removed from the product.
- The battery must be disposed of safely. Always dispose of batteries in collection bins.
- Keep batteries away from children and pets. Only adults should handle batteries.
- Never throw batteries into a fire or expose them to fire or other heat sources.
- Follow the battery safety and usage instructions.

DISPOSAL OF OLD ELECTRICAL APPLIANCES:

The European directive 2012/19/EU on Waste Electrical and Electronic Equipment (WEEE), requires that old household electrical appliances must not be disposed of in the normal unsorted municipal waste stream. Old appliances must be collected separately in order to optimize the recovery and recycling of the materials they contain and reduce the impact on human health and the environment. The crossed out “wheeled bin” symbol on the product reminds you of your obligation, that when you dispose of the appliance, it must be separately collected.



CAUTION: To avoid possible hearing damage, do not listen at high audio volume for long periods of time.

Occasionally, a few non-active pixels may appear on the screen as a fixed black, blue, green or red point. Please note that this does not affect the performance of your product. Take care not to scratch the screen with fingernails or other hard objects.

1300 663 868 | enquiries@aussietraveller.com.au | aussietraveller.com.au

BRISBANE SHOWROOM: 11-15 Oasis Court, Clontarf QLD 4019 | MELBOURNE SHOWROOM: 235 Barry Road, Campbellfield VIC 3061

ACCESSORIES

- 1 × User Manual
- 1 × Remote Control
- 1 × Power Adaptor
- 1 × 12V Adaptor

All the pictures in this manual are for your reference, appearance and display should subject to the final product.

The user interface may vary due to software upgrades.

FEATURES

- **24" LED DISPLAY**
This unit has a built-in LED display window to provide clear vision and low radiation.
- **Parental Control**
- **Support Auto TV Scanning**
- **Support Digital Broadcasting Reception**
- **Support TV Guide Function**
- **Support USB Multimedia Playback**
- **Support Multi-languages On Screen Display**
- **Support Full Function Remote Control**
- **Compatible with HDMI, LAN and AV Input**
- **Compatible with EARPHONE and OPTICAL Output**
- **With Detachable Stand Holder**
- **With External Antenna Jack**
- **With Built-in Speakers**

1300 663 868 | enquiries@aussietraveller.com.au | aussietraveller.com.au

BRISBANE SHOWROOM: 11-15 Oasis Court, Clontarf QLD 4019 | MELBOURNE SHOWROOM: 235 Barry Road, Campbellfield VIC 3061

GENERAL PARTS

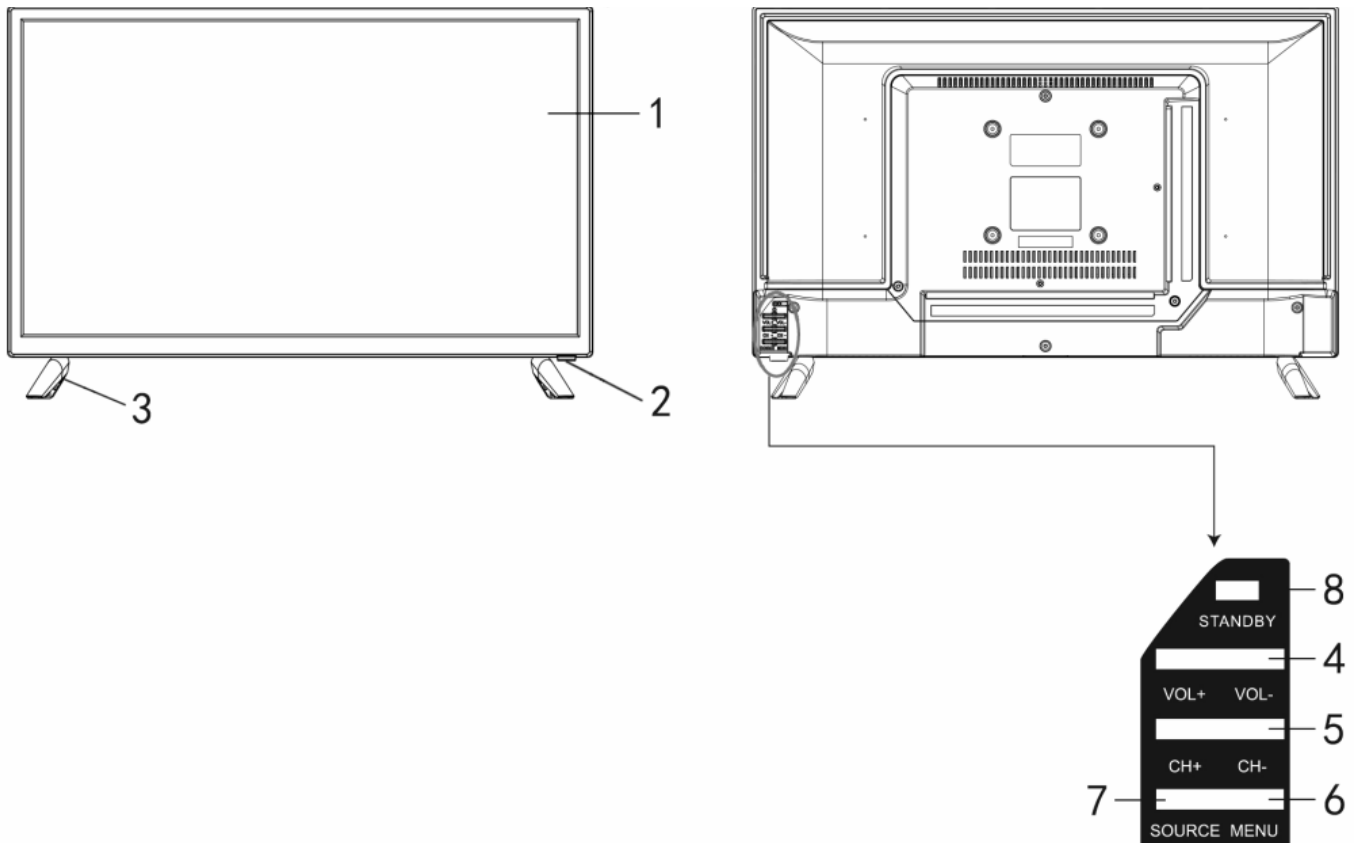

1. LED display screen.
2. Remote control sensor / Power indicator - In standby mode the indicator light is red; when switching on the unit the indicator light is blue colour.
3. Stand holder.
4. VOL +/- button - To increase/decrease the volume level or move left/right.
5. CH +/- button - To select next channel or move up / to select previous channel or move down.
6. MENU button - To enter menu setting page.
7. SOURCE button - To select the input source.
8. STANDBY button - To turn the TV ON/OFF.

1300 663 868 | enquiries@aussietraveller.com.au | aussietraveller.com.au

BRISBANE SHOWROOM: 11-15 Oasis Court, Clontarf QLD 4019 | MELBOURNE SHOWROOM: 235 Barry Road, Campbellfield VIC 3061

GENERAL PARTS (cont.)

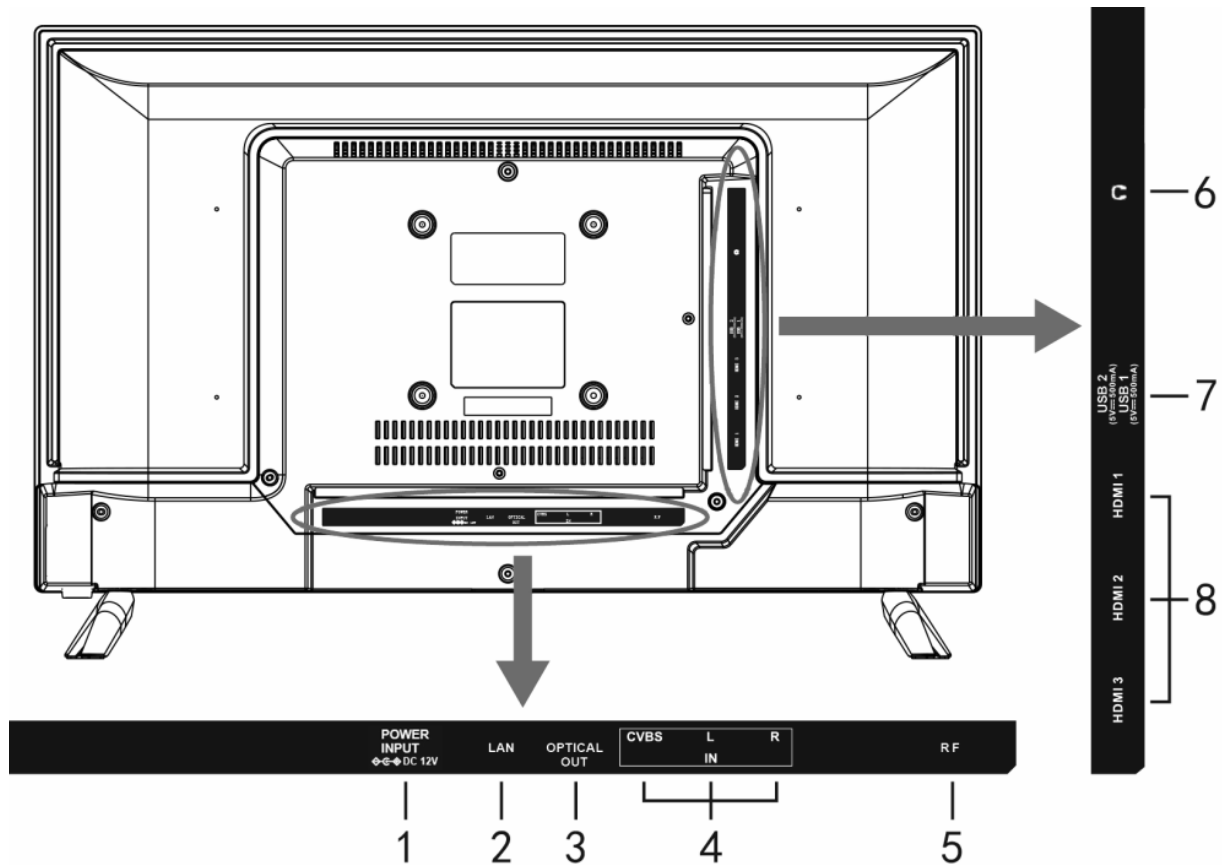

1. Power input (DC).
2. LAN (Local Area Network) input terminal.
3. OPTICAL input terminal.
4. CVBS and AUDIO L/R input terminals.
5. RF input terminal - To connect the external TV antenna (DVB T/DVB T2/DVB C)
6. EARPHONE output terminal.
7. USB 1/2 input terminal.
8. HDMI 1/2/3 input terminal.

1300 663 868 | enquiries@aussietraveller.com.au | aussietraveller.com.au

BRISBANE SHOWROOM: 11-15 Oasis Court, Clontarf QLD 4019 | MELBOURNE SHOWROOM: 235 Barry Road, Campbellfield VIC 3061

REMOTE CONTROL

1. **STANDBY**
Set the unit in standby mode; press it again to switch it on.
2. **INPUT**
Select a desired input source.
3. **NUMBER BUTTONS (0-9)**
Input the number information, such as channel number and so on.
4. **GUIDE**
Launch the Program Guide.
5. **CH. LIST**
Press to show channel list.
6. **4 x COLOR BUTTONS**
Customised in different page.
7. **MENU**
Call out the main menu or return to previous menu.
8. **▶||**
Press to operate start/pause playing; Move fast forward; Move fast backward.
9. **▲▼◀▶ / OK**
Move up, down, left, right / confirm.
10. **↶**
Return to the previous interface or menu.
11. **EXIT**
Exit the current interface or menu.
12. **HOME**
Press to enter home page.
13. **VOL +/-**
Increase/decrease the volume level.
14. **CH ▲▼**
Play the next/previous program.
15. **MUTE**
Mute the sound.
16. **SUBTITLE**
Select available subtitles.
17. **TEXT**
Turn on/off the Teletext.
18. **INFO**
Display the available program information.
19. **BROWSER**
Press to enter Browser.
20. **Browser icon**
Press to enter browser.
21. **DEEZER**
Access Deezer directly.
22. **CONTENT CHANNELS**
6 buttons to directly access content channels.



1300 663 868 | enquiries@aussietraveller.com.au | aussietraveller.com.au

BRISBANE SHOWROOM: 11-15 Oasis Court, Clontarf QLD 4019 | MELBOURNE SHOWROOM: 235 Barry Road, Campbellfield VIC 3061

REMOTE CONTROL PREPARATION

BATTERY INSTALLATION:

Install the batteries as the following pictures. Be sure + and – terminals are positioned as indicated in the battery compartment (Fig 1).

SERVICE LIFE OF BATTERIES:

- The batteries typically last for one year although this depends on how often the remote control is used.
- If the remote control fails to work even when it is operated near the player, replace the batteries.
- Use two size AAA dry batteries.

NOTE:

- Do not drop, step on or otherwise impact the remote control. This may damage the parts or lead to malfunction.
- If the remote control is not going to be used for a long time, remove the batteries.

REMOTE CONTROL OPERATION:

Point the remote control from no more than about 6m from the remote control sensor and within about 60° of the front of the player (Fig 2).

NOTE:

- The operating distance may vary according to the brightness of the room.
- Do not point bright light at remote control sensor.
- Do not place objects between the remote control and the remote control sensor.
- Do not use this remote control while simultaneously operating the remote control of any other appliances.

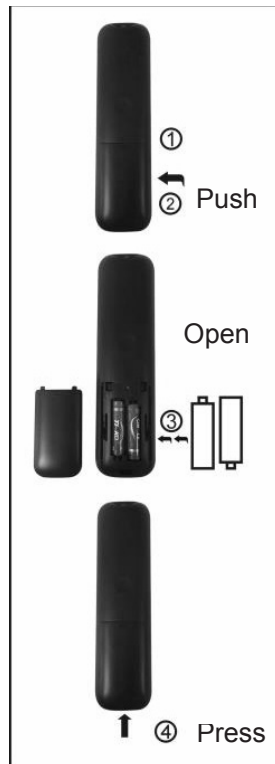

Fig 1

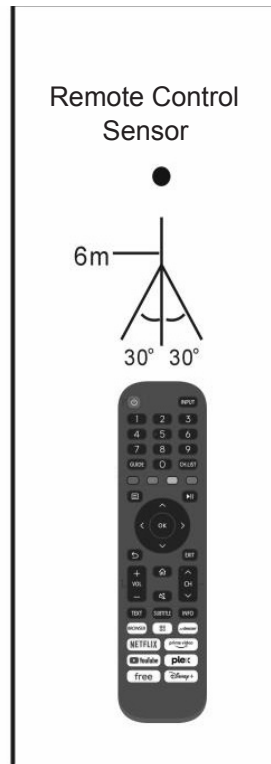

Fig 2

1300 663 868 | enquiries@aussietraveller.com.au | aussietraveller.com.au

BRISBANE SHOWROOM: 11-15 Oasis Court, Clontarf QLD 4019 | MELBOURNE SHOWROOM: 235 Barry Road, Campbellfield VIC 3061

BASIC CONNECTION

- Insert one end into the power jack on the back of the TV.
- Plug the other end of the adapter into the mains socket.

POWER CONNECTION:

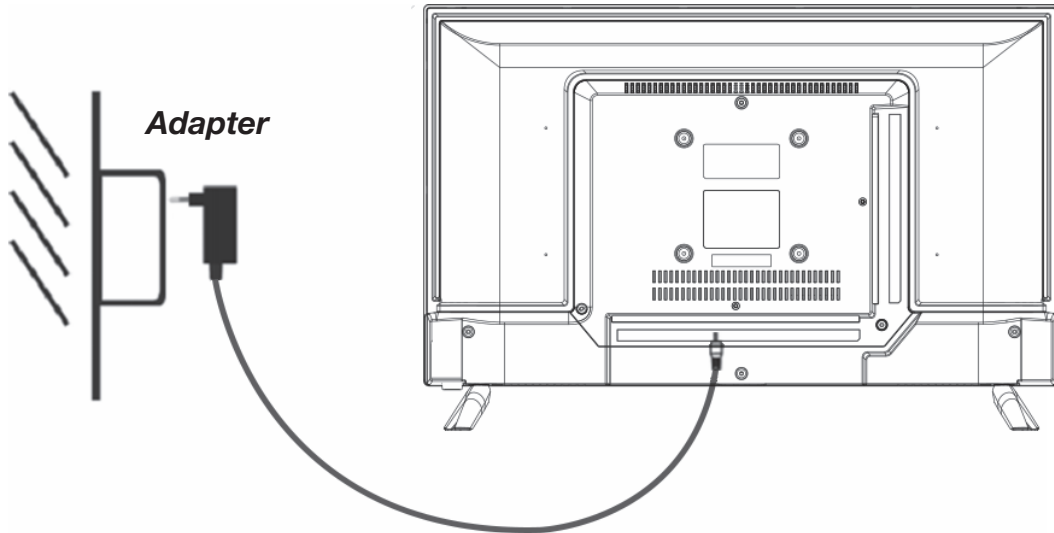

CONNECT EXTERNAL ANTENNA TO UNIT:

Install external antenna into antenna jack for best picture.

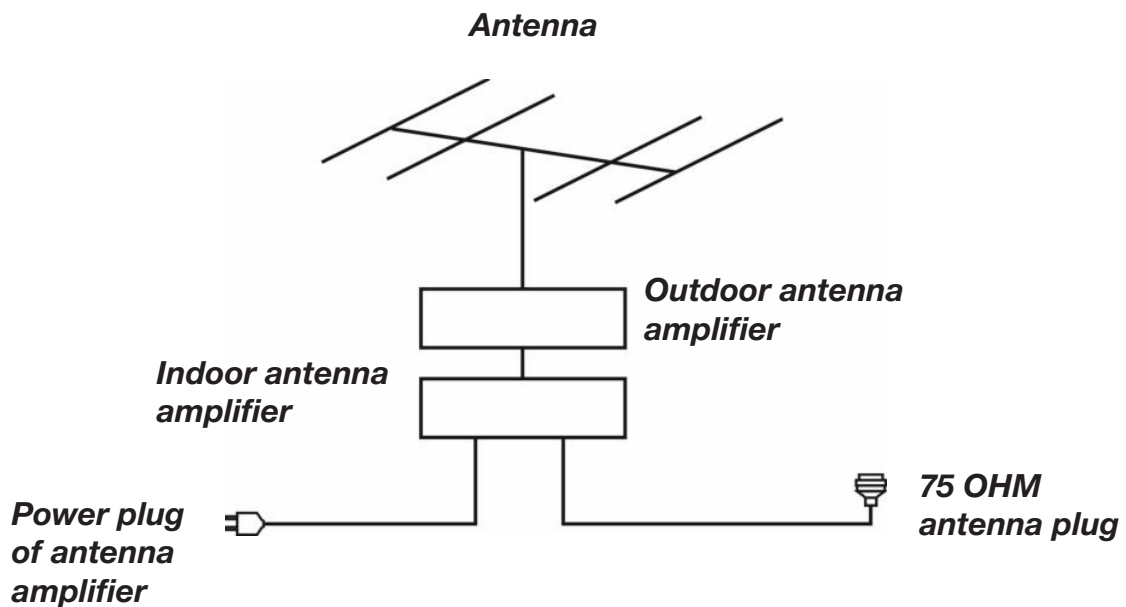

1300 663 868 | enquiries@aussietraveller.com.au | aussietraveller.com.au

BRISBANE SHOWROOM: 11-15 Oasis Court, Clontarf QLD 4019 | MELBOURNE SHOWROOM: 235 Barry Road, Campbellfield VIC 3061

BASIC CONNECTION (cont.)

LAN (LOCAL AREA NETWORK) CONNECTION:

Use a LAN cable (not included) to connect this TV with available network.

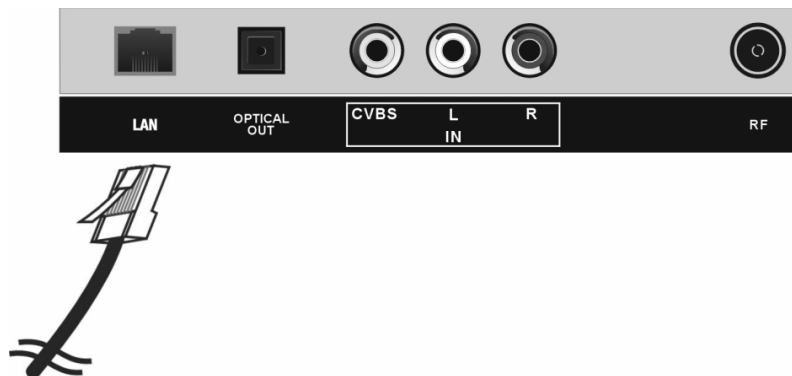

OPTICAL CONNECTION:

Use OPTICAL cable (not included) to connect the unit with amplifier or other audio decoding devices for coaxial audio signal output.

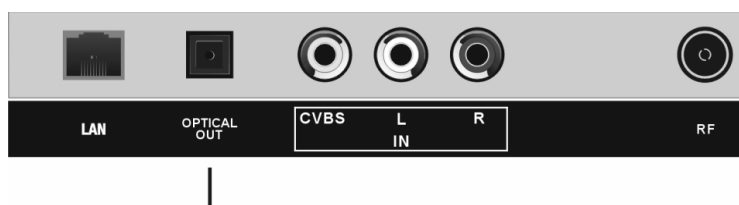

COMPOSITE AV (CVBS) CONNECTION:

For basic connection, use the composite Audio L/R (white/red) and CVBS (yellow) cable to connect the unit with other devices.

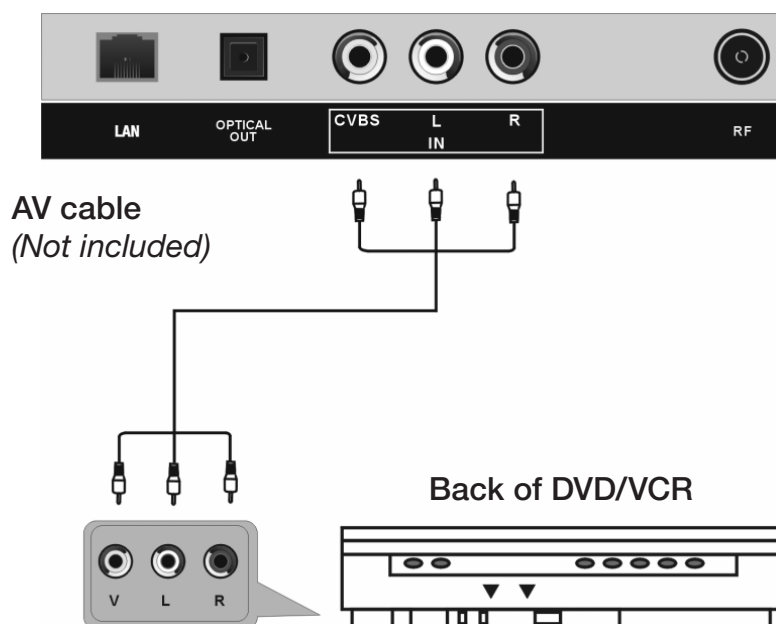

1300 663 868 | enquiries@aussietraveller.com.au | aussietraveller.com.au

BRISBANE SHOWROOM: 11-15 Oasis Court, Clontarf QLD 4019 | MELBOURNE SHOWROOM: 235 Barry Road, Campbellfield VIC 3061

BASIC CONNECTION (cont.)

HDMI CONNECTION:

Use HDMI cable to connect the unit with other devices to receive high definition multimedia signal.

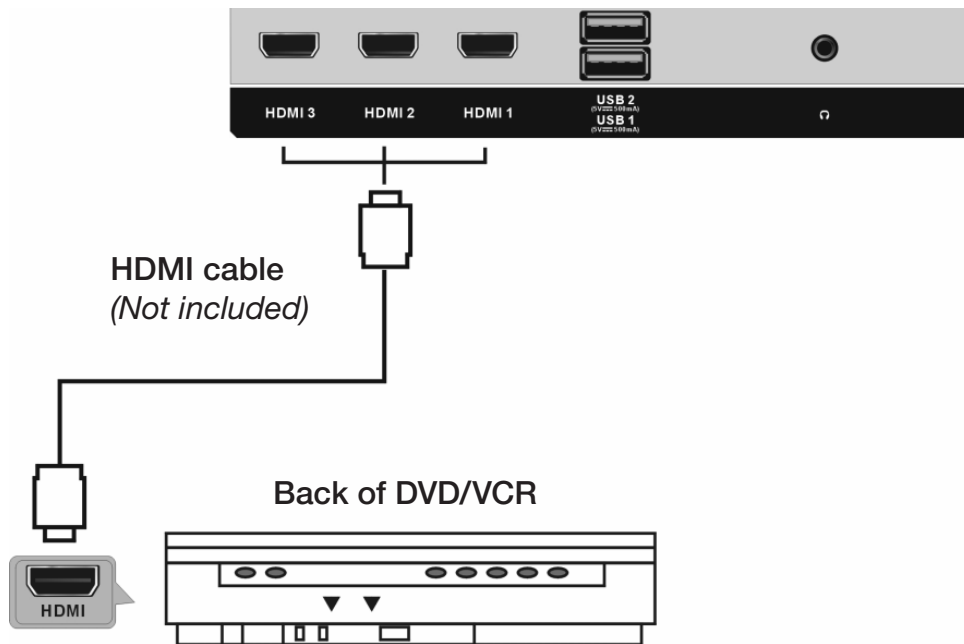

USB CONNECTION:

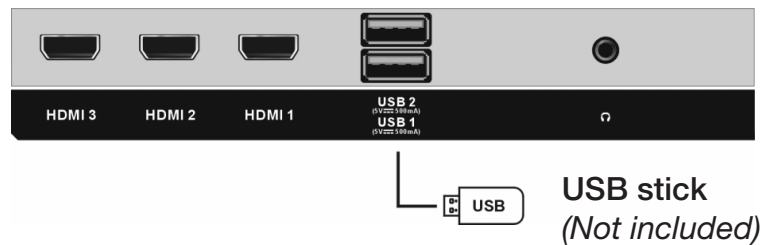

EARPHONE CONNECTION:

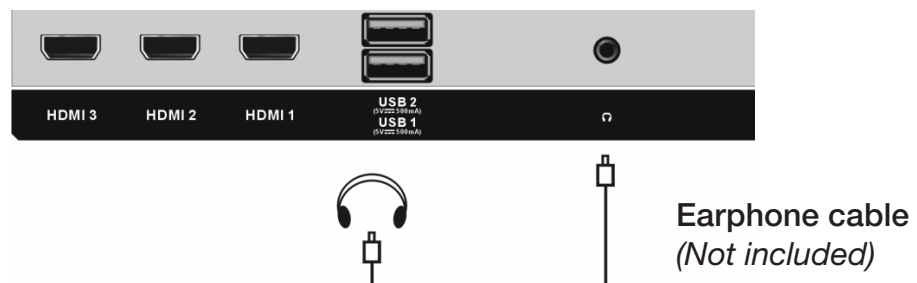



1300 663 868 | enquiries@aussietraveller.com.au | aussietraveller.com.au

BRISBANE SHOWROOM: 11-15 Oasis Court, Clontarf QLD 4019 | MELBOURNE SHOWROOM: 235 Barry Road, Campbellfield VIC 3061

BASIC OPERATIONS

- Ensure equipment and power plug has been connected properly and the unit is set in correct mode before operation.
- Press STANDBY button on the unit or remote control to power ON the unit (indicator will glow blue); press it again to power OFF (standby mode) the unit (indicator will glow red).

SELECT DESIRED PROGRAM:

1. Press CH  button to play next channel.
2. Press CH  button to play previous channel.
3. Press the number buttons on remote control directly to select desired program.

VOLUME CONTROL:

- Press VOL + or VOL - to adjust the level of current volume.
- Available range: 0–100

MUTE CONTROL:

- Press the  MUTE button to mute the sound, press it again to turn on the sound.

INPUT SETTING:

- Press INPUT button on the remote control to display the sources list.
- Press UP or DOWN navigation button to select desired input source, and then press OK button to confirm selection.

INFORMATION DISPLAY:

- Press INFO button on remote control to display information of current program.

MEDIA PLAYBACK:

- Insert a USB memory device into USB slot before following operations.
- Press INPUT button on remote control to switch the unit to USB mode.
- Press UP/DOWN/LEFT/RIGHT navigation button to move the cursor.
- Press BACK button to return to previous menu page.

FIRST TIME INSTALLATION:

- Connect to power source and turn on this TV.
- When turning on the TV for the first time, it will go straight into the installation menus.
- Press the UP/DOWN/LEFT/RIGHT buttons to navigate the menu and change the settings.
- Press the OK button to confirm.

1300 663 868 | enquiries@aussietraveller.com.au | aussietraveller.com.au

BRISBANE SHOWROOM: 11-15 Oasis Court, Clontarf QLD 4019 | MELBOURNE SHOWROOM: 235 Barry Road, Campbellfield VIC 3061

BASIC OPERATIONS (cont.)

SELECT A LANGUAGE:

- Press Up/Down buttons to select desired language, and press OK to the next step.

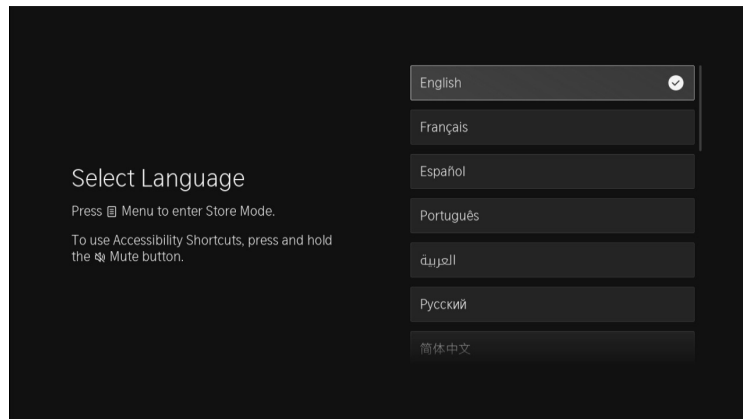

SELECT LOCATION:

- Press Up/Down button to select the related country, and press OK button to the next step.

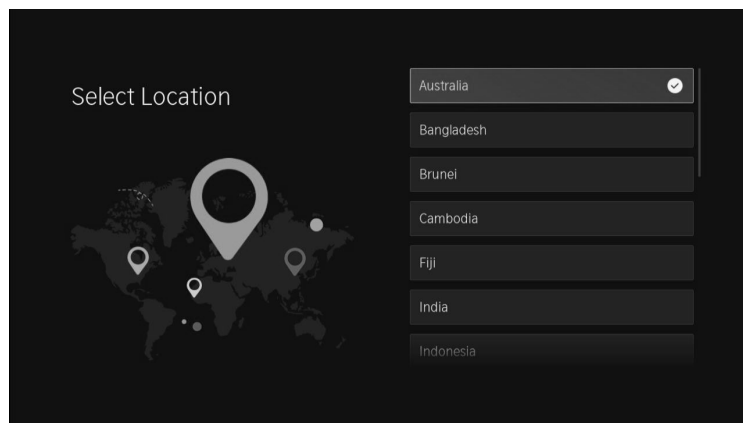

SELECT TIME ZONE:

- Press Up/Down button to select related time zone, and press OK button to the next step.

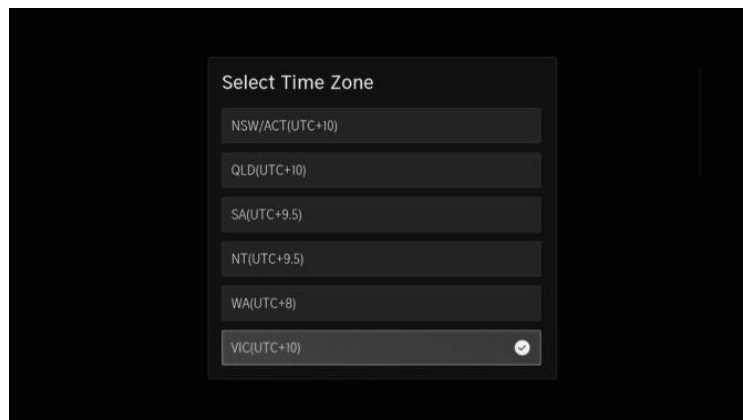

1300 663 868 | enquiries@aussietraveller.com.au | aussietraveller.com.au

BRISBANE SHOWROOM: 11-15 Oasis Court, Clontarf QLD 4019 | MELBOURNE SHOWROOM: 235 Barry Road, Campbellfield VIC 3061

BASIC OPERATIONS (cont.)

CHANNEL SCAN:

- Press Up/Down button to select channel scan, or Skip to continue TV setup.

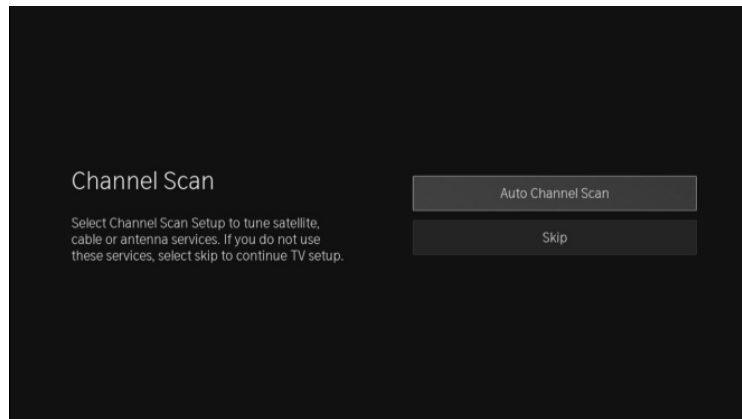

- Select Auto Channel Scan, and press OK button to enter Channel Scan Setup.
- Select Antenna or Cable, then highlight "Next" and press OK button.
- Set up the Channel/Scan Mode, then highlight "Start Scanning" and press OK button to start scanning.

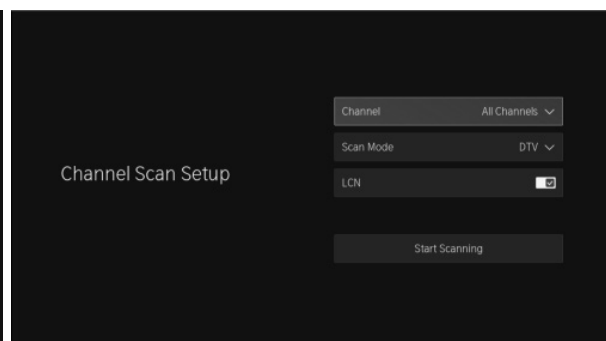
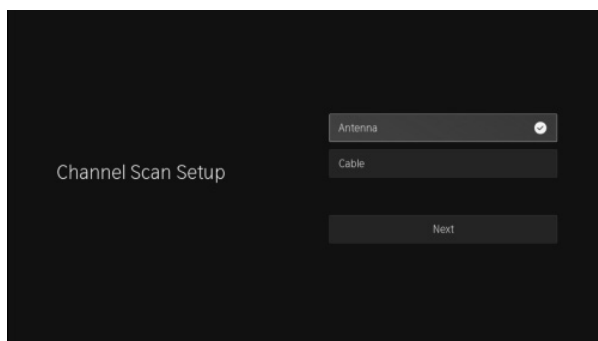

CONNECT TO INTERNET:

- Press Up/Down button to select available internet and input the password to connect; or select Skip.

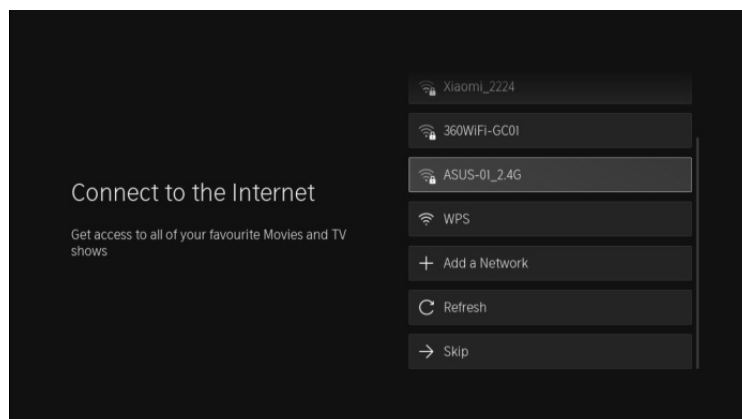

1300 663 868 | enquiries@aussietraveller.com.au | aussietraveller.com.au

BRISBANE SHOWROOM: 11-15 Oasis Court, Clontarf QLD 4019 | MELBOURNE SHOWROOM: 235 Barry Road, Campbellfield VIC 3061

BASIC OPERATIONS (cont.)

DATA SHARING, PRIVACY AND EULA:

- Press Up/Down button to highlight Select All, and press OK button to confirm the selection; then the cursor automatically jumps to OK & Go Next, and press OK to the next step.

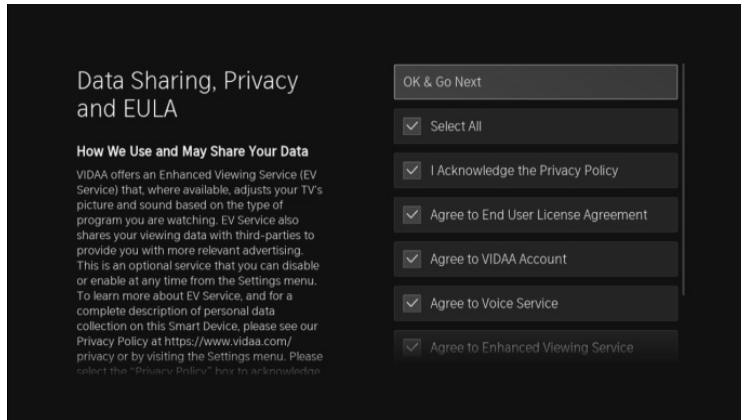

CREATE YOUR VIDAA ACCOUNT:

- Create an Account or Skip to the next step.

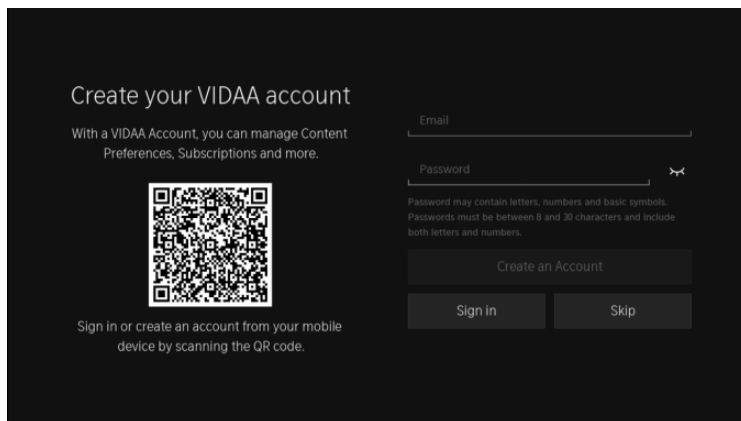

NAME TV:

- Press Up/Down button to select a unique name for your TV, to help identify it when casting or connecting to it from other devices; Press OK button to confirm.

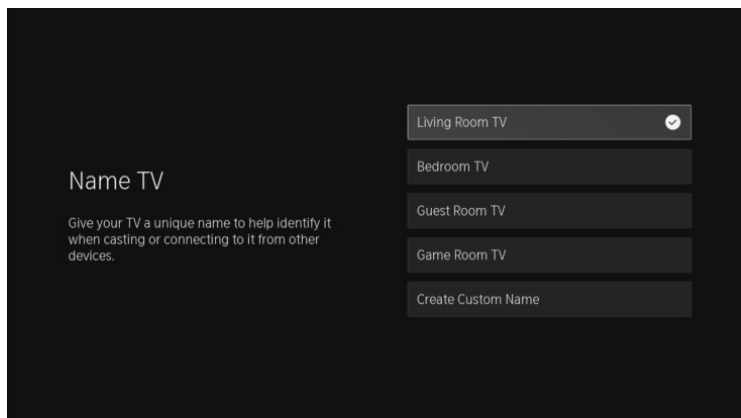

1300 663 868 | enquiries@aussietraveller.com.au | aussietraveller.com.au

BRISBANE SHOWROOM: 11-15 Oasis Court, Clontarf QLD 4019 | MELBOURNE SHOWROOM: 235 Barry Road, Campbellfield VIC 3061

BASIC OPERATIONS (cont.)

WELCOME TO VIDAA HOME:

- Press Right button to next step and enjoy your TV.

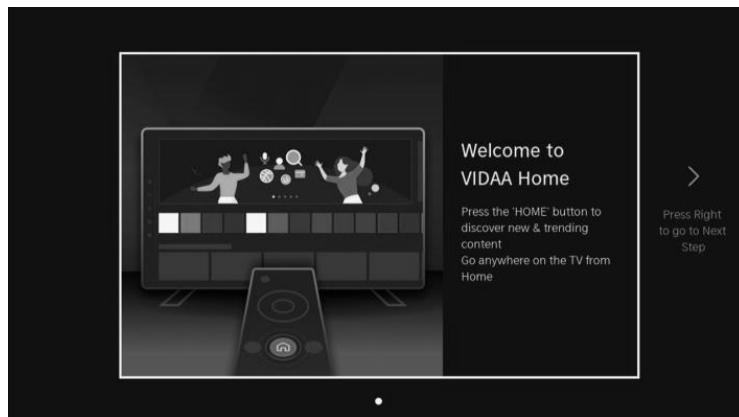

HOME PAGE

- Press  on remote control to enter the Home Page.



MANAGE APPS:

- Select the item you want to move, and long press OK button to move or uninstall app.
- **NOTE:** Some built-in applications of the system cannot be uninstalled.

MANAGE APPS:

- Sign in your VIDAA account. A VIDAA account gives you all the best feature of your smart TV and always keeps it up to date.

SEARCH:

- Search the app you want.

NOTIFICATIONS:

- Allow pop-up notifications to appear for useful information and events that occur with your TV.
- Select Notifications on the Home screen, and select **Settings** then display **Advertising, New Arrivals, Warnings And Legal Statements, System Message**, from which you can choose the types of notifications you would like to receive.

1300 663 868 | enquiries@aussietraveller.com.au | aussietraveller.com.au

BRISBANE SHOWROOM: 11-15 Oasis Court, Clontarf QLD 4019 | MELBOURNE SHOWROOM: 235 Barry Road, Campbellfield VIC 3061

HOME PAGE (cont.)

INPUT:

- Select the input you want.

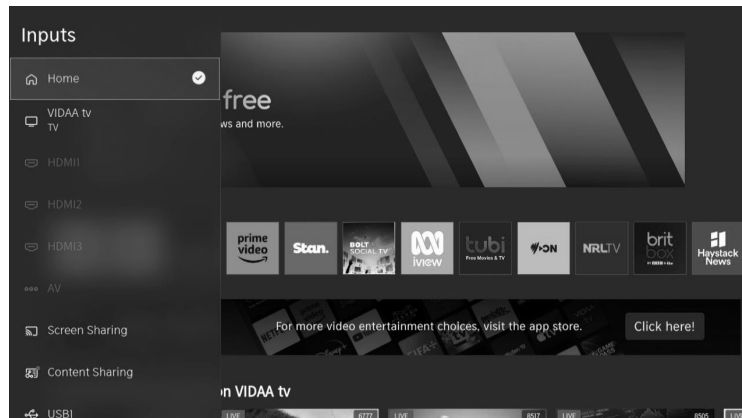

SETTINGS:

- Display the settings menu.

MAIN MENU

- Press > Settings, or in live TV, press > Settings to enter the main Menu.
- Press the Up/Down button to select Picture/Sound/Network/Channel/Accessibility/System/Support.

1. PICTURE

1.1 ADJUSTING THE PICTURE QUALITY

Adjust current picture mode to apply to all sources or just current source.

The menu is only for reference. The following modes may differ from the actual product.

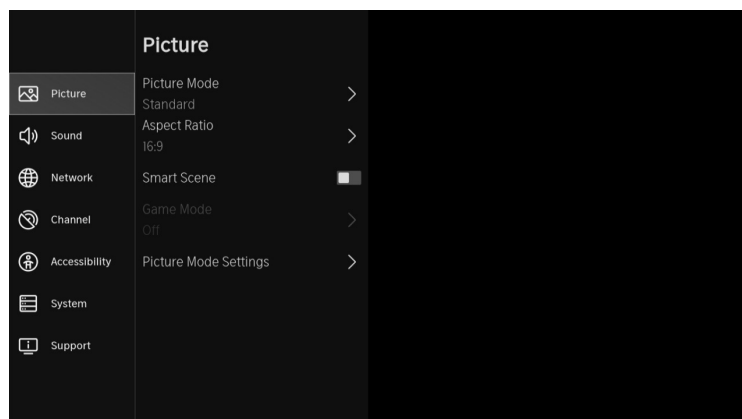

1300 663 868 | enquiries@aussietraveller.com.au | aussietraveller.com.au

BRISBANE SHOWROOM: 11-15 Oasis Court, Clontarf QLD 4019 | MELBOURNE SHOWROOM: 235 Barry Road, Campbellfield VIC 3061

MAIN MENU (cont.)

1.2 CHOOSING A PICTURE MODE

☰ > Settings > Picture > Picture Mode

You can select the Picture Mode that provides the best viewing experience:

- **Standard:** The default mode, to make users experience high-quality images under normal light.
- **Enhanced (ARC):** Enhance both image and sound quality for all input source automatically.
- **Cinema Day:** Enhance the contrast, color and clarity of the screen to make the color more vivid.
- **Cinema Night:** Reduce the screen contrast, color and clarity to make the screen looks soft.
- **Dynamic:** Enhance the contrast, color and clarity of the screen, so that the picture in the dynamic will balance the color.
- **Sports:** This mode is more suitable for watching sport video.

1.3 CHOOSING AN ASPECT RATIO

☰ > Settings > Picture > Aspect Ratio

You can adjust the Aspect Ratio to stretch or zoom the picture:

- Auto
- 16:9
- 4:3
- Movie Zoom

1.4 SMART SCENE

☰ > Settings > Picture > Smart Scene

Recognise the current scene and enhance the picture quality.

1.5 GAME MODE

☰ > Settings > Picture > Game Mode

Optimised for PC or Games consoles. Reduces Input Lag and improves responsiveness. Choosing the Game Mode under ON/OFF.

1.6 CONFIGURING ADVANCED PICTURE SETTINGS

☰ > Settings > Picture > Picture Mode Settings



1300 663 868 | enquiries@aussietraveller.com.au | aussietraveller.com.au

BRISBANE SHOWROOM: 11-15 Oasis Court, Clontarf QLD 4019 | MELBOURNE SHOWROOM: 235 Barry Road, Campbellfield VIC 3061

MAIN MENU (cont.)

Adjust display setting for each Picture Mode:

- **Apply Picture Settings:** Adjust current picture mode to apply to all sources or just current source.
- **Backlight:** Adjust image backlight.
Options:
 - Off
 - Low
 - High
- **Brightness:** Adjust image brightness.
- **Contrast:** Adjust image contrast.
- **Colour Saturation:** Adjust image colour density.
- **Sharpness:** Adjust the image edge sharpness.
- **Adaptive Contrast:** Automatically adjust dark areas and light areas of the image to see more details. Press navigation button to select Off/Low/Medium/High.
- **Noise Reduction:** Improve the picture quality by reducing noise.
Options:
 - Off
 - Low
 - Medium
 - High
- **MPEG Noise Reduction:** Reduces MPEG block noise to provide clearer edge transitions.
Options:
 - Off
 - Low
 - Medium
 - High
- **Colour Temperature:** Adjust the overall colour of the image.
Options:
 - Warm1
 - Warm2
 - Standard
 - Cool
- **Expert Settings:** Adjust the colour space and Gamma to best suit the content you're viewing.
- **Overscan:** Change the video size setting to crop the edges of the displayed image.
- **Reset Current Mode:** Restore all the picture settings in the current picture mode to the factory default values.

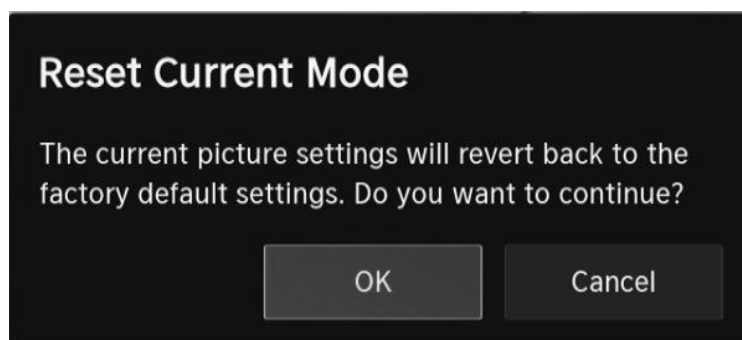

1300 663 868 | enquiries@aussietraveller.com.au | aussietraveller.com.au

BRISBANE SHOWROOM: 11-15 Oasis Court, Clontarf QLD 4019 | MELBOURNE SHOWROOM: 235 Barry Road, Campbellfield VIC 3061

MAIN MENU (cont.)

2. SOUND

2.1 ADJUSTING THE SOUND QUALITY

Adjust current sound mode to apply to all sources or just current source.

The menu is only for reference. The following modes may differ from the actual product.

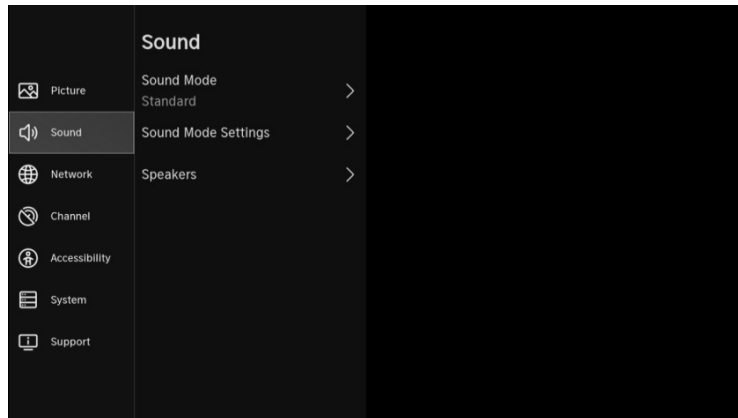

2.2 CHOOSING A SOUND MODE

☰ > Settings > Sound > Sound Mode

You can select a favourite sound mode suitable for the content type or the listening environment:

- **Standard:** Produced a balanced sound in all environment.
- **Enhanced (ARC):** Enhance both image and sound quality for all input source automatically.
- **Theatre:** Increased the surround sound effect and provides a more prominent bass response.
- **Music:** Preserves the original sound. Good for musical programs.
- **Speech:** Low and high frequencies are attenuated to improve the reproduction and clarity of the human voice.
- **Late Night:** Improve the reproduction and clarity of the human voice with a low volume level.
- **Sports:** Optimised sound for watching Sports events.

2.3 SOUND MODE SETTINGS

☰ > Settings > Sound > Sound Mode Settings

Adjust the audio settings of the TV:

- Apply Audio Settings
- Equalizer
- Wall Mount Setup
- Auto Volume Control
- Reset Current Mode

2.4 SPEAKERS

☰ > Settings > Sound > Speakers

Select the speakers which you want to use.

1300 663 868 | enquiries@aussietraveller.com.au | aussietraveller.com.au

BRISBANE SHOWROOM: 11-15 Oasis Court, Clontarf QLD 4019 | MELBOURNE SHOWROOM: 235 Barry Road, Campbellfield VIC 3061

MAIN MENU (cont.)

3. NETWORK - GET ACCESS TO THE INTERNET THROUGH YOUR TV

The menu is only for reference. The following modes may differ from the actual product.

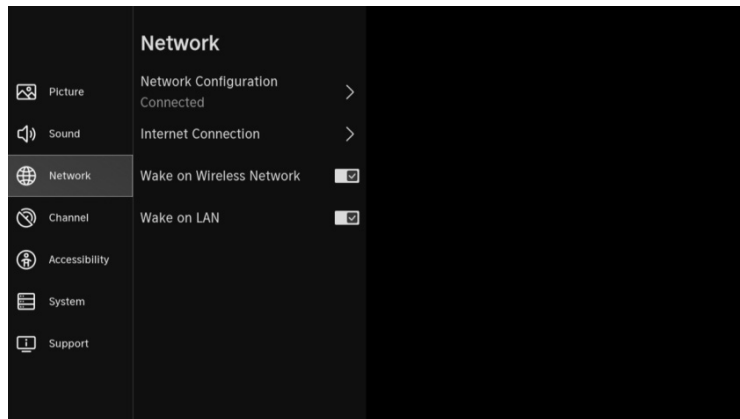

3.1 CONNECTING TO THE INTERNET

☰ > Settings > Network > Network Configuration

You set the TV network by selecting Configuration and press the OK button to enter the sub menu.

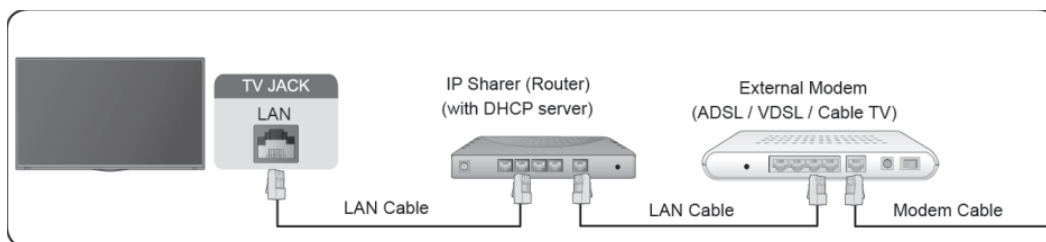

Automatically Obtain an IP Address

1. If you connect to the wired network, the TV will automatically obtain an IP address and connect to the network.
2. If the connection fails, disconnected message will display for the Ethernet status. Retry or enter the IP settings, and select Manual to input the information again.

Manually Enter an IP Address

1. Enter the IP settings to select Manual.
2. Enter the IP Address, Netmask, Gateway, DNS Server 1 and DNS Server 2 in the menu.

NOTE:

- You get access to the Internet through your TV.
- The default option of IP Settings Mode is DHCP.

1300 663 868 | enquiries@aussietraveller.com.au | aussietraveller.com.au

BRISBANE SHOWROOM: 11-15 Oasis Court, Clontarf QLD 4019 | MELBOURNE SHOWROOM: 235 Barry Road, Campbellfield VIC 3061

MAIN MENU (cont.)

3.2 CONNECTING TO A WIRELESS NETWORK

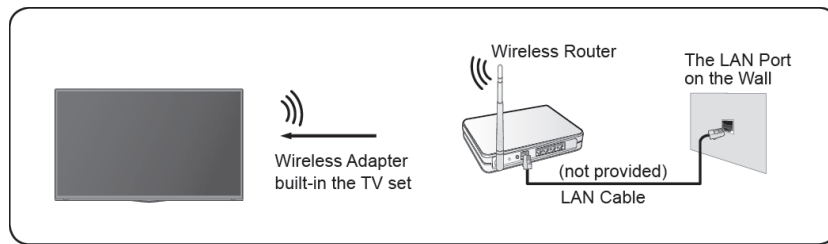

NOTE:

- You get access to the Internet through your TV.
- Connect to an available wireless network.
- Make sure that you have the wireless router's SSID and password before attempting to connect.

☰ > Settings > Network > Network Configuration

You set the TV network by selecting Configuration and press the OK button to enter the sub menu.

- **Connection Type:** Choose a wireless network connection to access the Internet.
- **Refresh:** Refresh wireless network.
- **Advanced Settings:** Configure the advanced wireless network settings for the TV.
- **Add:** You can add a wireless network.

NOTE:

- If no wireless router is found, select **Add** and enter the network name in the SSID.
- If no wireless router is found, select **Refresh**.

3.3 INTERNET CONNECTION

☰ > Settings > Network > Internet Connection

Check the internet connection.

3.4 WAKE ON WIRELESS NETWORK

☰ > Settings > Network > Wake on Wireless Network

Using WLAN, turn on your TV with your TV with your mobile device.

3.5 WAKE ON LAN

☰ > Settings > Network > Wake on LAN

Using Ethernet, turn on your TV with your TV with your mobile device.

1300 663 868 | enquiries@aussietraveller.com.au | aussietraveller.com.au

BRISBANE SHOWROOM: 11-15 Oasis Court, Clontarf QLD 4019 | MELBOURNE SHOWROOM: 235 Barry Road, Campbellfield VIC 3061

MAIN MENU (cont.)

4. CHANNEL

The menu is only for reference. The following modes may differ from the actual product.

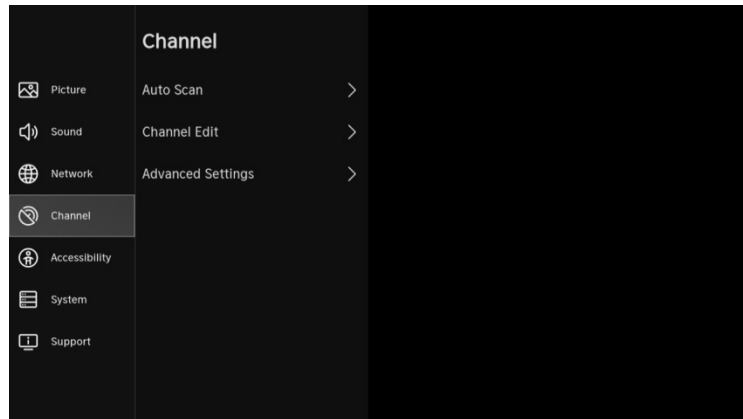

4.1 CHANNEL SCAN

☰ > Settings > Channel > Auto Scan

NOTE: Before you select Auto Channel Scan, you can press ☰ > Settings > Channel Auto Scan, press OK button into the sub menu, select Change Setup and press OK button to select Antenna or Cable.

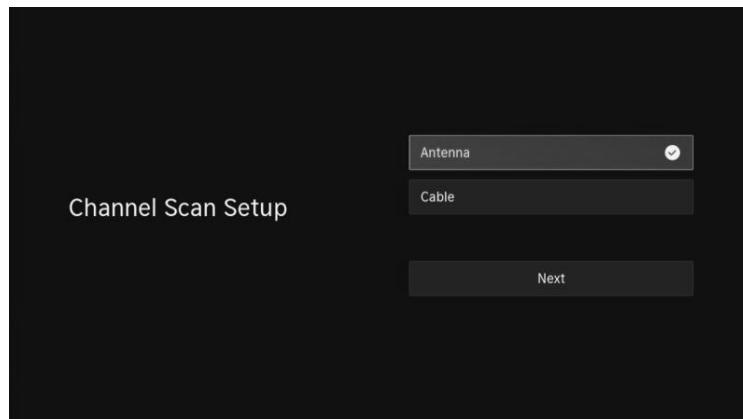

1300 663 868 | enquiries@aussietraveller.com.au | aussietraveller.com.au

BRISBANE SHOWROOM: 11-15 Oasis Court, Clontarf QLD 4019 | MELBOURNE SHOWROOM: 235 Barry Road, Campbellfield VIC 3061

MAIN MENU (cont.)

4.2 CHANNEL LIST

 > Channel List

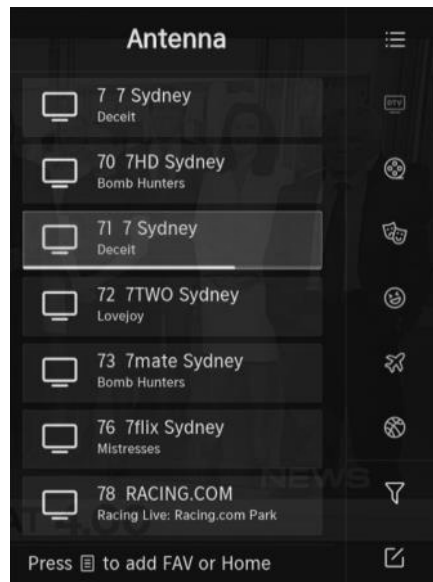

Display the channel list.

- In Live TV, press OK button on the remote control, or press  > Channel List to display the channel list menu.



4.3 FAVOURITES LIST

Adding channels to your 'Favourites' list.

- Press OK button to call out the channel list. The channel list appears on the right side of the screen.
- Press  > OK to select your favourite channel.
- Press  and choose Add to Favourite, a heart shaped icon will appear next to your favourite channel.

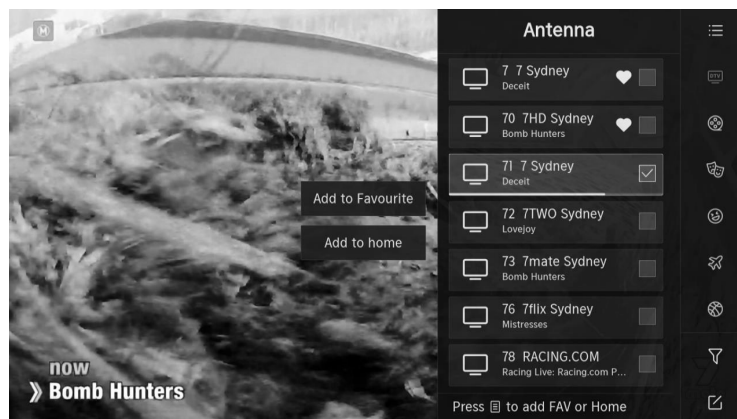

1300 663 868 | enquiries@aussietraveller.com.au | aussietraveller.com.au

BRISBANE SHOWROOM: 11-15 Oasis Court, Clontarf QLD 4019 | MELBOURNE SHOWROOM: 235 Barry Road, Campbellfield VIC 3061

MAIN MENU (cont.)

Viewing your 'Favourites' list.

- Press OK button to call out the channel list. The channel list appears on the right side of the screen.
- Press > > Favourite > >, press the Navigation button select FAV1, FAV2, FAV3 or FAV4 press OK and your favourite channel with a heart-shaped icon will appear on the favourite list.

Deleting channels on your 'Favourites' list.

- Press OK button to call out the channel list. The channel list appears on the right side of the screen.
- Press > > Favourite, using the Navigation button to select ✎ (Edit) into the sub menu, select the FAV channel that you want to delete.
- Press > to delete.

NOTE: These steps should be operated under TV inputs. Before you edit the favourite lists, complete channel scan first.

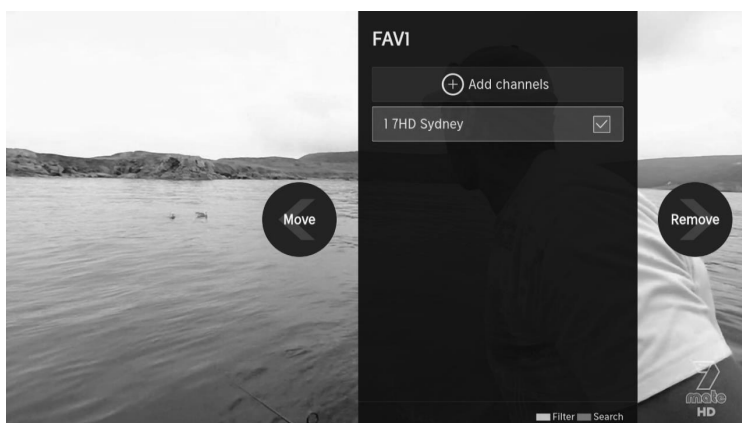

4.4 TV GUIDE

In Live TV, display the TV Guide.

- Press GUIDE button on remote control, or press [Grid] > Guide, to call out the Guide.
- Press Up/Down navigation button to select preferred channel.
- Press Left/Right navigation button to select preferred programme of some channel.
- Press the RED button to display a list of scheduled reminders.
- Press the YELLOW button to display the program guide of the previous day.
- Press the BLUE button to display the program guide of the following day.

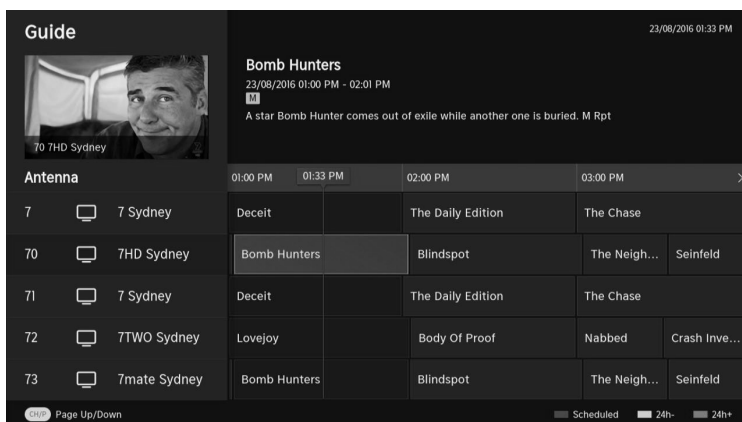

1300 663 868 | enquiries@aussietraveller.com.au | aussietraveller.com.au

BRISBANE SHOWROOM: 11-15 Oasis Court, Clontarf QLD 4019 | MELBOURNE SHOWROOM: 235 Barry Road, Campbellfield VIC 3061

MAIN MENU (cont.)

4.5 CHANNEL EDIT

☰ > Settings > Channel > Channel Edit

Manually edit the channel list to your preference.

4.6 ADVANCED SETTINGS

☰ > Settings > Channel > Advanced Settings

Advanced channel settings.

5. ACCESSIBILITY

The menu is only for reference. The following modes may differ from the actual product.

5.1 PROVIDE MENU OPTION TO AID THE VISUALLY OR HEARING IMPAIRED

- **High Contrast Menu:** Turn High Contrast Menu On or Off.
- **Menu Transparency:** Set the transparency of menu.
Options:
 - Off
 - Medium
 - High
- **Audio Type:** Accessibility audio settings.
- **Dialogue Enhancement:** Enable or disable dialogue enhancement.
- **Subtitle Settings:** Adjust Subtitle Settings for digital broadcast content.
- **Screen Magnification:** Allow visually impaired/partially sighted viewers to magnify an area of the screen.
- **Voice Guide:** Voice Guide setup.

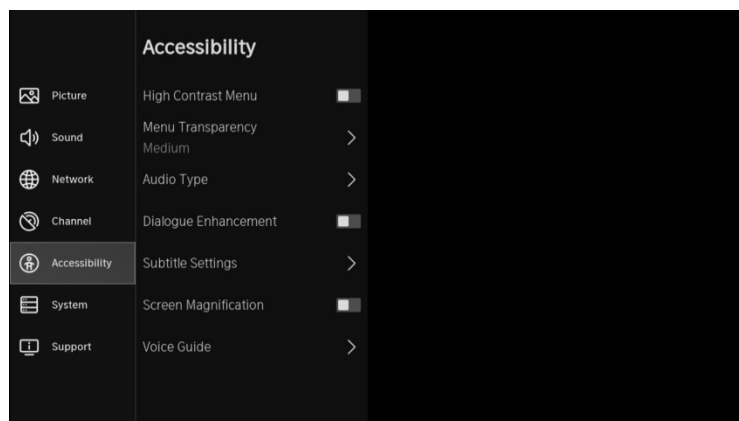

1300 663 868 | enquiries@aussietraveller.com.au | aussietraveller.com.au

BRISBANE SHOWROOM: 11-15 Oasis Court, Clontarf QLD 4019 | MELBOURNE SHOWROOM: 235 Barry Road, Campbellfield VIC 3061

MAIN MENU (cont.)

6. SYSTEM SETTINGS

The menu is only for reference. The following modes may differ from the actual product.

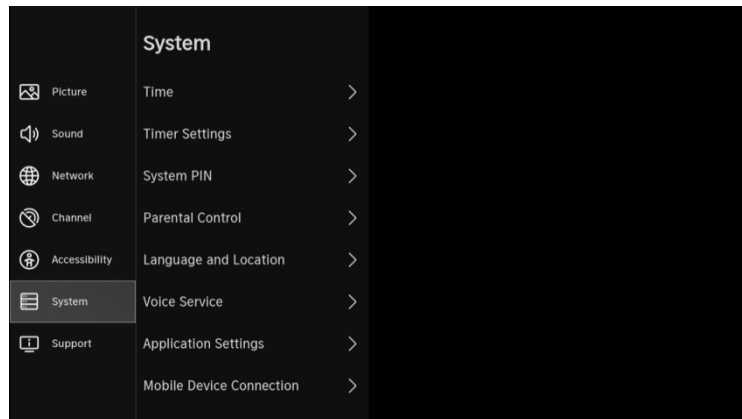

6.1 SETTING THE TIME

☰ > Settings > System > Time

Set the current time based on your location.

- **Time Format:** Set the time to display in a 12 or 24-hour format.
- **Date/Time:** Set the date and time.
- **Time Zone:** Set the time zone.
- **Daylight Savings:** Select whether to apply Daylight Savings Time to the TV.

6.2 USING THE TIMER

☰ > Settings > System > Timer Settings

Adjust the timer settings to suit your preference.

- **Sleep Timer:** Set the sleep timer to automatically turn the TV Off within a specified time: Off, 15 Minutes, 30 Minutes, 60 Minutes, 90 Minutes, 120 Minutes, User Defined.
- **Power On Timer:** Set the clock for the time you want the TV to turn on automatically. You can set the time only once or set the time in specified date weekly.
- **Power Off Timer:** Set the clock for the time you want the TV to turn off automatically. You can set the time only once or set the time in specified date weekly..
- **Menu Timeout:** Set the amount of time that you would like for the menu to display: Off, 10s, 20s, 30s, 60s.
- **Auto Standby with No Signal:** TV will go to standby if there is no signal after the set time: Off, 15min.

6.3 SYSTEM PIN

☰ > Settings > System > System PIN

Change the PIN that you use to access Parental Control, Auto Channel Scan and Reset to Factory Default.

6.4 PARENTAL CONTROL

☰ > Settings > System > Parental Control

Turn on Parental Controls to prevent children from being able to view certain content.

1300 663 868 | enquiries@aussietraveller.com.au | aussietraveller.com.au

BRISBANE SHOWROOM: 11-15 Oasis Court, Clontarf QLD 4019 | MELBOURNE SHOWROOM: 235 Barry Road, Campbellfield VIC 3061

MAIN MENU (cont.)

6.5 LANGUAGE AND LOCATION

☰ > Settings > System > Language and Location

Choose the language of the TV and your location.

6.6 VOICE SERVICE

☰ > Settings > System > Voice Service

Download the VIDAA app on your mobile, then you can use your voice to control the TV, other smart home devices and more.

6.7 APPLICATION SETTINGS

☰ > Settings > System > Application Settings

Set up Application preferences.

6.8 MOBILE DEVICE CONNECTION

☰ > Settings > System > Mobile Device Connection

Connection management of a mobile device, smartphone, or personal computer.

6.9 HDMI & CEC

☰ > Settings > System > HDMI & CEC

You can use your TV remote to control the external devices that are connected to the TV by HDMI cable. The external devices need to support HDMI & CEC Function (HDMI-CEC).

1. Set HDMI Control to On.
2. Connect an HDMI-CEC-compliant device to the TV.
3. Turn on the connected external device. The device is automatically connected to the TV. After connection is finished, you can access the menu of the connected device on your TV screen using your TV remote and control the device.

NOTE:

- HDMI cables must be used to connect HDMI CEC-compatible devices to your TV.
- The HDMI CEC feature of the connected device must be turned on.
- If you connect an HDMI device that is not HDMI CEC-compatible, all the HDMI-CEC control features do not work.
- Depending on the connected HDMI device, the HDMI-CEC Control feature may not work.
- The HDMI CEC features that are supported:
 - - One Touch Play
 - - Routing Control
 - - System Standby
 - - Device OSD Name Transfer
 - - Remote Control Pass Through
 - - Give Device Power Status
 - - System Audio Control

1300 663 868 | enquiries@aussietraveller.com.au | aussietraveller.com.au

BRISBANE SHOWROOM: 11-15 Oasis Court, Clontarf QLD 4019 | MELBOURNE SHOWROOM: 235 Barry Road, Campbellfield VIC 3061

MAIN MENU (cont.)

HDMI Device

- Connect an HDMI cable from an external A/V equipment.
- Some devices such as DVD player require HDMI signal to be set to output in the device's settings. Please consult your device user manual for instructions.
- Please note that the HDMI connector provides both video and audio signals, it's not necessary to connect an audio cable.

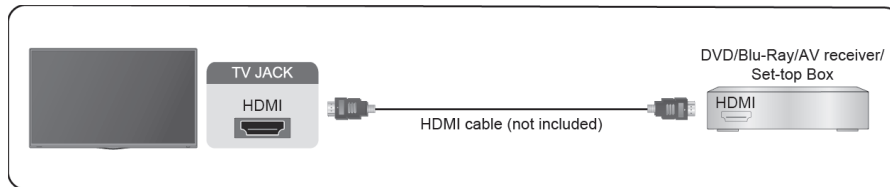

6.10 ADVANCED SETTINGS

☰ > **Settings** > **System** > **Advanced Settings**

Access the Advanced Settings menu.

7. SUPPORT

The menu is only for reference. The following modes may differ from the actual product.

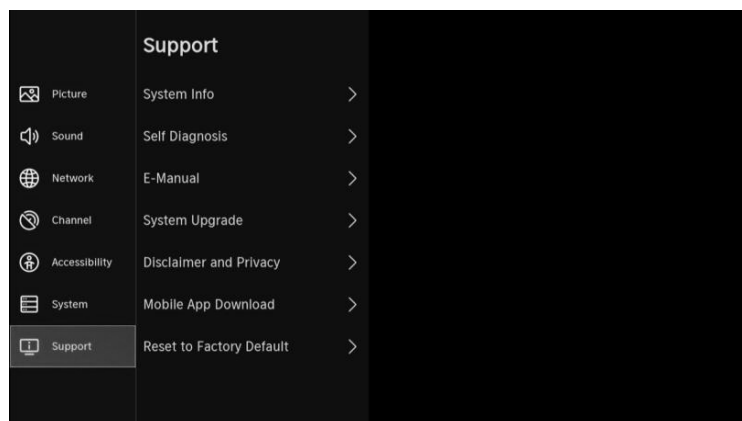

7.1 SYSTEM INFO

☰ > **Settings** > **Support** > **System Info**

View System information.

7.2 SELF DIAGNOSIS

☰ > **Settings** > **Support** > **System Info**

Perform self-diagnosis to test sound, picture and connections.

1300 663 868 | enquiries@aussietraveller.com.au | aussietraveller.com.au

BRISBANE SHOWROOM: 11-15 Oasis Court, Clontarf QLD 4019 | MELBOURNE SHOWROOM: 235 Barry Road, Campbellfield VIC 3061

MAIN MENU (cont.)

7.3 E-MANUAL

☰ > Settings > Support > E-Manual

Launch the E-Manual and get to know more about your TV:

- First-Time Use
- Enjoy Live TV
- Benefits of Smart TV
- Connecting to External Devices,
- Settings Overview
- Entertainment
- Accessibility Features
- Troubleshooting

7.4 SYSTEM UPGRADE

☰ > Settings > Support > System Upgrade

Set your TV to receive the latest firmware.

- **Auto Firmware Upgrade:** Set your TV to automatically receive the latest firmware.
- **Check Firmware Upgrade:** Check to ensure that your TV has received the latest firmware.
NOTE: Please ensure your TV is connected to the Internet.
- **System App Auto Upgrade:** App auto upgrade will be done in the background. May need your confirmation on new Privacy Notices to complete upgrade in the progress.
- **Upgrade From USB:** Upgrade TV software from USB device.

NOTE:

- Please ensure the USB flash drive insert to USB2.0 port of the TV.
- The updating files must be available in root directory.
- The format of the USB must be FAT32 and the partition table type must be MBR.

7.5 DISCLAIMER AND PRIVACY

☰ > Settings > Support > Disclaimer and Privacy

Click to read the Disclaimer details.

7.6 MOBILE APP DOWNLOAD

☰ > Settings > Support > Mobile App Download

Install mobile app on your smartphone to control your TV. This app is available on both Android and iOS.

7.7 RESET TO FACTORY DEFAULT

☰ > Settings > Support > Reset to Factory Default

Restore your TV to the factory default.

1300 663 868 | enquiries@aussietraveller.com.au | aussietraveller.com.au

BRISBANE SHOWROOM: 11-15 Oasis Court, Clontarf QLD 4019 | MELBOURNE SHOWROOM: 235 Barry Road, Campbellfield VIC 3061

MULTI-SCREEN

SCREEN SHARING:

Mirror content from your device to the TV.

INPUT > Screen Sharing

- Turn on the casting function of your Android / Windows10 device.
- Find the TV name in the searching list of your device and select it. Wait for the connection progress to complete and the content on your device will be displayed on the TV.

NOTE: Some Android devices may not support casting.

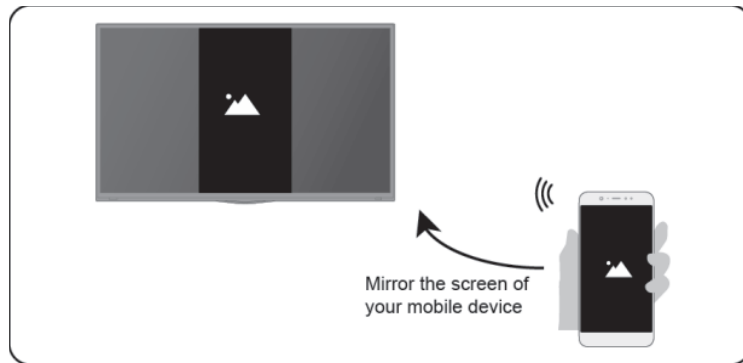

CONTENT SHARING:

Share media content, like videos, music or photos, from your device to the TV screen.

Before you use this function, turn on Content Sharing at  > **Settings > System > Mobile Device Connection > Content Sharing.**

Establishing Content Sharing connection between the TV and your device:

1. Turn on the content sharing function of your device.
2. Find the TV name in the searching list of your device and select it.
3. Wait for the connection progress to complete, and select the content you want to share.

SMART FUNCTIONS

USB DEVICE:

Connect the USB devices such as hard drives, USB sticks and digital cameras for browsing photos, listening to music. Support format: FAT32

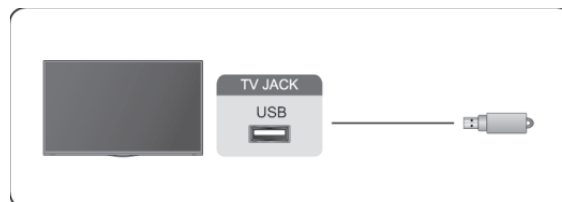

1300 663 868 | enquiries@aussietraveller.com.au | aussietraveller.com.au

BRISBANE SHOWROOM: 11-15 Oasis Court, Clontarf QLD 4019 | MELBOURNE SHOWROOM: 235 Barry Road, Campbellfield VIC 3061

SMART FUNCTIONS (cont.)

MEDIA:

Playing Media content.

🏠 > Media

By default, there is Content Sharing displayed on the Media screen. If your mobile device is connected to the TV, its name also appears on the Media screen.

NOTE: For more information about Content Sharing, refer to its detailed introduction.

🏠 > Media > Connected Device

Select the content you want to play on the screen, like pictures, videos and music.



1. Input the content name you want to play.
2. Arrange the content list by Grid, List.
3. Arrange the content list by Name, Date Modified, Size.
4. Filter the content list by All Media, Photo, Video, Music, Recorded.
5. Create a photo, music, or video playlist.

Playing background music during viewing pictures

You need to:

- Choose a picture to playback.
- Press \wedge / \vee button to call out play bar.
- Select Background Music and choose your music to create a Music Playlist.
- Play the background music during viewing pictures.

NOTE: The TV may be support the following file formats:

MEDIUM	FILE FORMAT
VIDEO	.MP4, .MOV, .MPG, .MPEG, .FLV
PICTURE	.JPG, .BMP, .PNG, .GIF
MUSIC	.MP3, .AAC, .WAV

For more information about connection to other device, refer to the detailed introduction of each part.

1300 663 868 | enquiries@aussietraveller.com.au | aussietraveller.com.au

BRISBANE SHOWROOM: 11-15 Oasis Court, Clontarf QLD 4019 | MELBOURNE SHOWROOM: 235 Barry Road, Campbellfield VIC 3061

MAINTENANCE

- Be sure to press STANDBY button to set the player to the standby mode and disconnect the power plug before maintaining the player.
- If the surface is extremely dirty, wipe clean with a cloth which has been dipped in a weak soap water solution and wrung out thoroughly, and then wipe again with a dry cloth.
- Never use alcohol, benzene, thinner, cleaning fluid or other chemicals. And do not use compressed air to remove dust.
- Wipe the player with a dry, soft cloth IN CASE there are scratches on the display panel the warranty is void.

WALL MOUNTING

- Contact a professional for assistance when wall mounting your TV. We are not responsible for any damage to the product or injury to yourself if you mount the TV on your own.
- Do not wall mount the TV while TV is turned on. It may cause personal injury due to electric shock.
- Use standard BM4*10mm screws (4 pieces, not included) to mount this TV.

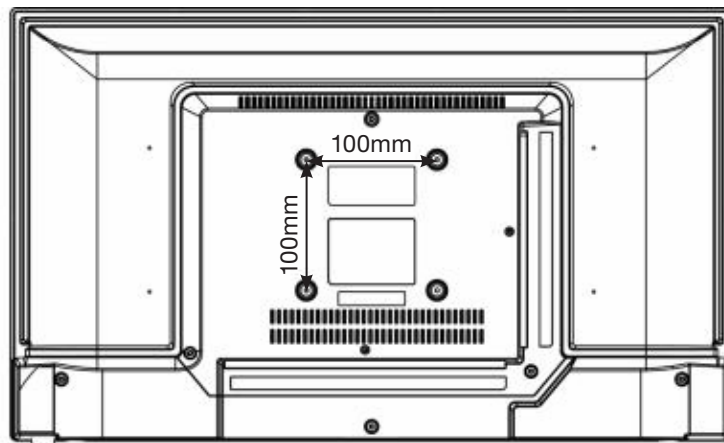

Back of TV

1300 663 868 | enquiries@aussietraveller.com.au | aussietraveller.com.au

BRISBANE SHOWROOM: 11-15 Oasis Court, Clontarf QLD 4019 | MELBOURNE SHOWROOM: 235 Barry Road, Campbellfield VIC 3061

STAND INSTALLATION

Your TV may be packaged with the Stand and the Cabinet separated. Before enjoying this TV, please carry out the Stand Installation according to the instructions below.

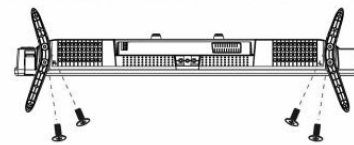
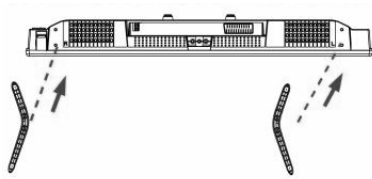
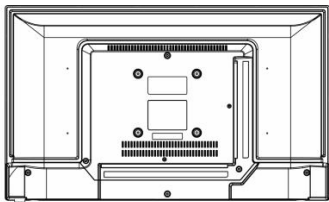

STEP 1

Place the TV faced down on a soft cloth or cushion to prevent the panel from being damaged.

STEP 2

Align the Stand with TV bottom and then force the end of stand until the TV is fully seated on the stand.

STEP 3

Tighten the included screws with a screwdriver.

NOTES:

- Unplug the power plug first when installing or removing the TV Stand.
- To avoid any damage to this TV, contact one or more people for assistance when installing or removing the TV stand.

SPECIFICATIONS

DISPLAY DEVICE	24" LED TV
RESOLUTION	1366 × 768px
DISPLAY COLOURS	16.7M
CONTRAST RATIO	3000:1
ASPECT RATIO	16:9
LIFE TIME	30,000hrs
USB MULTIMEDIA PLAYBACK FORMAT	MOVIE: AVI, MPG, MPEG
	MUSIC: MP3
	PHOTO: JPG/PNG
POWER SOURCE	DC 12V
POWER CONSUMPTION	Max. 36W
OPERATION TEMPERATURE	-5°C–45°C
DIMENSIONS (LxWxH)	553 × 166 × 370mm
WEIGHT	2.31kg
WIFI FREQUENCY	2400–2483.5 MHz
MAXIMUM TRANSMITTED WIFI POWER	18.5 dBm

Specifications are subject to change without notice.

1300 663 868 | enquiries@aussietraveller.com.au | aussietraveller.com.au

BRISBANE SHOWROOM: 11-15 Oasis Court, Clontarf QLD 4019 | MELBOURNE SHOWROOM: 235 Barry Road, Campbellfield VIC 3061

TROUBLESHOOTING

Check the following points before assuming malfunctions of this unit:

SYMPTOM - GENERAL	REMEDY
No power	Insert the power plug securely into the power outlet.
No picture	Ensure that the equipment is connected properly.
No sound / distorted sound	<ul style="list-style-type: none"> • Ensure that the equipment is connected properly. • Ensure that the input setting for the TV and stereo system are correct. • Adjust the master volume to a suitable volume by pressing VOL+/VOL button.
No operations can be performed with the remote-control	<ul style="list-style-type: none"> • Check the batteries are installed with the correct polarities. • The batteries are exhausted: Replace them with new ones. • Point remote control at the remote-control sensor and operate it again. • Operate the remote-control unit at a distance of no more than 6m from the remote control sensor. • Remove the obstacles between the remote-control and remote-control sensor.
No key operation (by the main unit and/or the remote control) is effective	Disconnect the power plug and then reconnect it. (The player may not be operating properly due to lightning, static electricity or some other factors.)
SYMPTOM - TV MODE	REMEDY
No or poor picture	<ul style="list-style-type: none"> • Adjust antenna or use an external antenna. • Relocate the unit near a window (if inside a building). • Move units away from this product that causes interference. • Do Auto Tuning again.
No or poor sound	<ul style="list-style-type: none"> • Check the audio settings. • Press MUTE button on remote control to cancel mute function. • Unplug the headphone.
Noise or other interference	Electronic equipment near the unit is causing interference. Relocate the unit or move the equipment.

1300 663 868 | enquiries@aussietraveller.com.au | aussietraveller.com.au

BRISBANE SHOWROOM: 11-15 Oasis Court, Clontarf QLD 4019 | MELBOURNE SHOWROOM: 235 Barry Road, Campbellfield VIC 3061

WARRANTY STATEMENT

Aussie Traveller Pty Ltd ACN 642 775 460 (**Aussie Traveller**) offers the following warranty in relation to the products it supplies directly or through an authorised manufacturer, dealer or approved service repair agent (**Product**).

Australian Consumer Law

The benefits of this warranty are in addition to any rights and remedies imposed by Australian State and Federal legislation that cannot be excluded. Nothing in this warranty is to be interpreted as excluding, restricting or modifying any State or Federal legislation applicable to the supply of goods and services which cannot be excluded, restricted or modified.

If you are a consumer as defined in the Australian Consumer Law: *Our goods come with guarantees that cannot be excluded under the Australian Consumer Law. You are entitled to a replacement or refund for a major failure and compensation for any other reasonably foreseeable loss or damage. You are also entitled to have the goods repaired or replaced if the goods fail to be of acceptable quality and the failure does not amount to a major failure.*

Warranty

Aussie Traveller warrants that, subject to the exclusions and limitations below, all parts of the manufacture and assembly of the Product will be free from defects in materials and workmanship (**Warranty**) for a period of 12 months from the date of purchase as follows:

1. This Warranty is activated at the time of purchase by the final retail customer (being the owner of the Product).
2. In the event the Product is purchased by a manufacturer, dealer or approved service repair agent, this Warranty will commence at the time the final retail customer makes payment for the Product to the wholesale purchaser.
3. If the Product is purchased directly from Aussie Traveller for use by final retail customer and not to be on sold in any way, the Warranty will commence at the time of the original purchase.

Warranty Period

This Warranty cannot be assigned or transferred to a subsequent owner of the Product.

The purchaser or final retail customer should inspect the Product immediately when received or at vehicle handover, to ensure that it appears free from any damage or defect, and matches the description provided.

If after accepting the Product, a defect appears in the manufacture or assembly of the Product before the end of the Warranty Period and Aussie Traveller finds the Product to be defective in materials or workmanship, Aussie Traveller will, in its sole discretion, either:

- a. replace, repair or refund the Product or the defective part of the Product free of charge; or
- b. cause the Product or the defective part of the Product to be replaced or repaired by a qualified repairer free of charge.

In arranging Warranty inspection, service and repair, Aussie Traveller will seek to provide the details of an approved service agent within your geographic area. Should one not be available, or if the Product is in use in travel, Aussie Traveller reserves the right to seek to arrange a repair or replacement at the next available location on the route of travel.

Aussie Traveller reserves the right to replace defective parts of the Product with parts and components of similar quality, grade and composition where an identical part or component is not available.

Products presented for repair may be replaced by refurbished goods of the same type rather than being repaired. Refurbished parts may be used to repair the Product.

Aussie Traveller Awning Products

This Warranty covers specified defects in materials or workmanship for Awning Products as follows:

1. The vinyl fabric is warranted against:
 - a. holes caused by mildew (mildew will form on dust and dirt and stain fabric if fabric is not kept clean).
 - b. excessive cracking, peeling, hardening or loss of strength while used under normal conditions.
 - c. excessive fading (a slight colour change may occur due to ultraviolet rays).
2. All hardware components including the roller are warranted not to bend or break under normal use (excluding high winds, water pooling and accidents).

Making a Warranty Claim

If a defect covered by this Warranty appears, the Customer must first contact Aussie Traveller within 7 days of first becoming aware of the defect. Aussie Traveller will assist the Customer to rectify and resolve any Product issue that may arise.

When making a claim under this Warranty, Aussie Traveller requires that the following information be provided before any further action will be taken.

1. Original Invoice (Document or Number);
2. Make and model of the Product;
3. Make and model of the vehicle (if Product fitted);
4. Vehicle build date (if Product fitted);
5. Vehicle chassis number;
6. Description of damage and/or repair required;
7. Photos of the damage and/or repair; and
8. Appropriate documentation (such as historical and maintenance records).

Aussie Traveller reserves the right to request more information or images should what is provided not be sufficient to make an assessment for the Warranty claim.

The Product must be made available to Aussie Traveller or its authorised repair agent for inspection and testing. If such inspection and testing find no defect in the Product, the final retail customer must pay Aussie Traveller's usual costs of service work and testing.

The final retail customer must bear the cost of the transport of the Product to and from Aussie Traveller or the authorised repair agent, and all insurance of the Product.

Exclusions

This Warranty will not apply where:

- the Product has been repaired, altered or modified by someone other than Aussie Traveller, or without the written consent of Aussie Traveller or an authorised repair agent;
- the alleged defect in the Product is within acceptable industry tolerances and variances;
- Aussie Traveller cannot establish any fault in the Product after testing and inspection;
- the Product has been used other than for the purpose for which it was designed;
- the alleged defect in the Product has arisen due to the final retail customer's failure to properly use and maintain the Product in accordance with any of Aussie Traveller's instructions, recommendations and specifications (including applicable maintenance schedules);
- the alleged defect in the Product has arisen due to the final retail customer's request to customise the Product;
- the Product has been subject to abnormal conditions, including environment, temperature, high or excessive wind, water, fire, humidity, pressure, stress or similar;
- the alleged defect has arisen due to abuse, misuse, neglect or accident;
- unauthorised parts or accessories have been used on or in relation to the Product;
- the Product has been overloaded or involved in an accident;
- the alleged damage or defect has been caused by normal wear and tear;
- the alleged damage to fabric has been caused by storm, wind or rain, or stretching of fabric caused by water pooling on fabric;
- breakage or bending of hardware components has been caused by storm, wind or rain, or water pooling on fabric.

Replacement Warranty Item

If, under Warranty, a Product is replaced or repaired by Aussie Traveller or an Aussie Traveller agent, unless provided in writing to indicate otherwise, the replacement Product will carry the **remaining** Warranty terms and conditions, including length of time, of the original purchased Product.

Change of Mind

Aussie Traveller understands that at times, final retail customers may change their mind. Choose carefully as return and credit requests for items purchased by mistake or "change of mind" reasons may not be approved. Aussie Traveller will not accept Product returns under these circumstances unless by written approval by an authorized Aussie Traveller representative. If approved, an administration and restocking fee may apply.

Limitations

Aussie Traveller makes no express warranties or representations other than set out in this Warranty.

The repair or replacement of the Product or part of the Product is the absolute limit of Aussie Traveller's liability under this express Warranty.

Contact

Australia Wide: 1300 663 868

Melbourne Office

235 Barry Road
Campbellfield, Melbourne, 3061
Ph: +61 3 9357 6565
enquiries@aussietraveller.com.au

Brisbane Head Office, Factory & Showroom

11-15 Oasis Court
Clontarf, Brisbane, 4019
Ph: +61 7 3284 3284
enquiries@aussietraveller.com.au

To receive a copy of the Aussie Traveller Warranty Terms & Conditions or information regarding specific Aussie Traveller products, please contact Aussie Traveller Head Office on (07) 3284 3284 or email enquiries@aussietraveller.com.au.

