

CARAVAN COMPONENTS

TELAIR AIR CONDITIONERS

WASHING MACHINES

SOG VENTILATION

NORTHSTAR WATER PUMPS

RANGEHOODS

PICNIC TABLES

TRAVELCLOUD MATTRESSES

ROOF HATCHES

THULE ROOF VENT

INTERIOR CARAVAN/RV FAN

Telair

BREEZE THROUGH YOUR NEXT ADVENTURE

ICE S AIR CONDITIONERS



You don't have to miss out on holidays throughout Australia just because heat and humidity might make your stay unbearable.

Telair, one of Europe's Premier Brands', range of Air Conditioner's will make your days pleasurable and relaxing. A sense of wellbeing will accompany you throughout your holiday, with the system constantly cooling, heating and controlling the air temperature of the air inside your motorhome or caravan.

Telair's flat and aerodynamic roof-mounted air conditioner's are the perfect solution, taking up minimal space inside the vehicle. The ICE S diffuser's modern super-flat design (just 4.2cm thick), saves space while still looking sleek.

Fitted with an efficient and silent system for distributing cold or hot air that can reach any part of the vehicle. The two main outputs are connected to an adjustable flow separator that allows air to be distributed in two directions (front-rear) or allows the flow to be adjusted gradually until it is all concentrated in just one direction. The two outputs can also be oriented up and down to maximise comfort.

Diffuser includes an LED display that indicates function from heating/cooling status to room temperature — allowing you to always be in control. Additional LED light strips produce a soft, ambient lighting in your caravan or RV.

RECOMMENDED VEHICLE SIZE

Both ICE S 2800 and ICE S 2400 (releasing 2023) models are specially designed to be installed on the roofs of most caravan and RV sizes from small (3m) to large (7m). Special care has been taken to ensure there is low noise both inside and outside the caravan. Suitable for roofs 30–70mm thick.

To determine which model is needed, check length of vehicle and match to below table:

ICE S 2800	10–20ft	3–7m
------------	---------	------

FEATURES

HEAT PUMP—High-efficiency heat pump is effective for outside temperatures down to 0°C.

AUTOMATIC CONTROL—The AUTO function selects the speed and temperature automatically.

REMOTE CONTROL—Infrared remote control with large display & programmable timer.

ANTI-FREEZE PROTECTION PROBES—Protects your air conditioner from freezing over.

INTERNAL FILTERS—Honeycomb filters are easily changed and removed for washing.

FITS MOST CARAVAN & RVS—Suitable for roofs 30–70mm thick.



For full specifications and pricing see our website. For trade & wholesale pricing please speak to one of our sales reps.

GET IN TOUCH WITH OUR FRIENDLY TEAM

1300 663 868 | enquiries@aussietraveller.com.au | aussietraveller.com.au

BRISBANE SHOWROOM: 11-15 Oasis Court, Clontarf QLD 4019 | MELBOURNE SHOWROOM: 235 Barry Road, Campbellfield VIC 3061

ICE S 2800 SPECIFICATIONS

PART NUMBER	30000128001000
POWER SUPPLY	230V 50Hz sinusoidal
MAX CURRENT CONSUMPTION	4.8Amp/hr
PEAK CURRENT	18A (0.15 sec)
COOLING POWER CONSUMPTION	990 Watts
HEATING POWER CONSUMPTION	950 Watts
COMPRESSOR SOFT START	73ms
RATED COOLING CAPACITY	2800 Watts
RATED HEATING CAPACITY	2450 Watts
OPERATING TEMPERATURE	0–48°C
TEMPERATURE ADJUSTMENT RANGE	16–31°C
INTERNAL FAN SPEED NUMBER	3
MAX INTERNAL AIR FLOW	450 m/hr
TYPE / QUANTITY OF COOLANT GAS	R32 / 450g
WATERPROOF RATING	IP X4
GENERATOR REQUIRED	2200 Watts
DIMENSIONS	23.9 x 98 x 65cm
DIFFUSER DIMENSIONS	4.2 x 45 x 45cm
ROOF CUT OUT DIMENSIONS	36 x 36cm or 40 x 40cm
WEIGHT	36kg
CERTIFICATION	
SAA 211731 CB-SG PSB-HS 09266	
AS/NZI 4417 AS/NZI 60335.2.40:2019 AS/NZI 60335.1:2020	

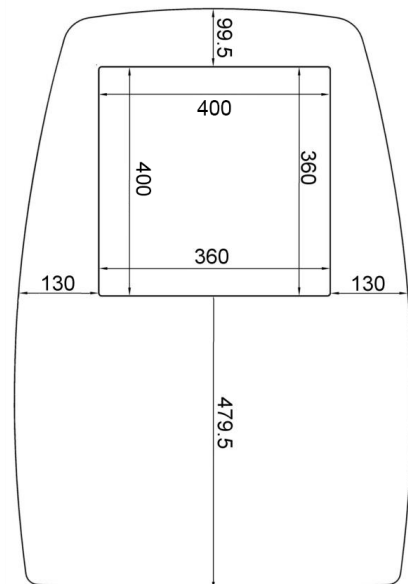

ICE S 2800 DIMENSIONS

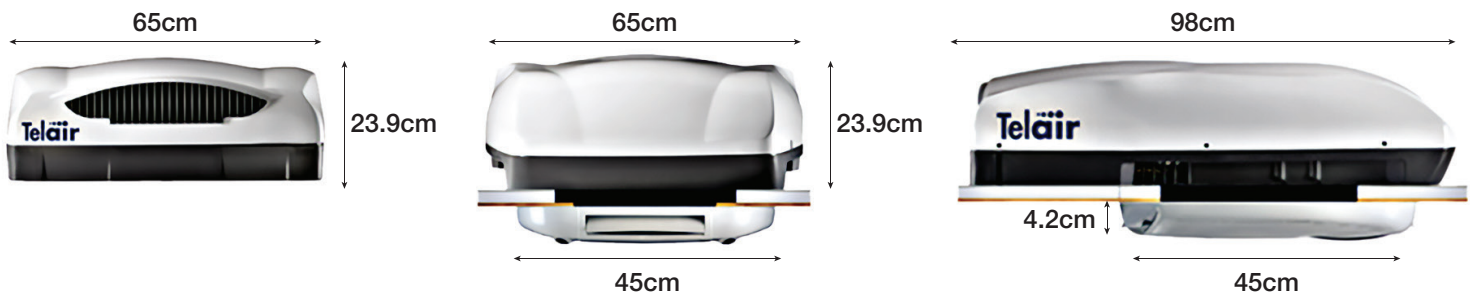

GET IN TOUCH WITH OUR FRIENDLY TEAM

1300 663 868 | enquiries@aussietraveller.com.au | aussietraveller.com.au

BRISBANE SHOWROOM: 11-15 Oasis Court, Clontarf QLD 4019 | MELBOURNE SHOWROOM: 235 Barry Road, Campbellfield VIC 3061

TOP-LOADER WASHING MACHINES



Forget trying to scrounge up coins for the communal laundry with this compact top-loader that fits right into your caravan or RV.

Aussie Traveller's new range of top load RV washing machines are now available, adding to the ever-growing range of Aussie Traveller RV and caravan specific products.

Featuring 2.5kg and 3.2kg capacity models, all Aussie Traveller Washing Machines are top loading 240 Volt (240V) cold water inlet with left hand or right hand water outlet choice. They also feature lint filter, water inlet filter, a stainless-steel wash drum and full wash cycle choices. Choose from rapid wash all the way to a full cycle wash.

The Aussie Traveller washing machines also contain a carry basket, that also works as a drum stabilizer, and full rubber hose assembly.

These compact washing machines are a great addition to your vehicle as they are lightweight, the 2.5kg weighs 17kg and the 3.2kg model weighing 18.5kg.

FEATURES

- Cold water wash
- Full wash cycle range
- White body profile with grey frosted top lid
- Easy to read display
- Full range of spare parts available
- Includes carry basket



For full specifications and pricing see our website. For trade & wholesale pricing please speak to one of our sales reps.

GET IN TOUCH WITH OUR FRIENDLY TEAM

1300 663 868 | enquiries@aussietraveller.com.au | aussietraveller.com.au

BRISBANE SHOWROOM: 11-15 Oasis Court, Clontarf QLD 4019 | MELBOURNE SHOWROOM: 235 Barry Road, Campbellfield VIC 3061

SPECIFICATIONS



2.5KG TOP LOAD WASHING MACHINE
PART NUMBER: 5100020002000



3.2KG TOP LOAD WASHING MACHINE
PART NUMBER: 5100020001000

MODEL	2.5KG WASHING MACHINE	3.2KG WASHING MACHINE
WASH CAPACITY	2.5kg	3.2kg
AIR DRYING	Yes	Yes
MAX WATER VOLUME	20L	26L
FULL CYCLE WATER USAGE	68L	75L
LED DISPLAY	Yes	Yes
PROGRAMS	5	5
WATER LEVEL	3	3
MAX INPUT POWER	235W	235W
WEIGHT	17kg	18.5kg
PRODUCT DIMENSIONS	410 x 420 x 640mm	410 x 420 x 740mm

SPARE PARTS	PART NUMBER
Top Load Washing Machine Lid	5100020003000
Top Load Washing Machine Filter	5100020004000
Top Load Washing Machine Overflow Hose	5100020005000
Top Load Washing Machine Inlet Hose	5100020006000
Top Load Washing Machine Basket	5100020007000
Top Load Washing Machine Drain Hose	5100020008000



GET IN TOUCH WITH OUR FRIENDLY TEAM

1300 663 868 | enquiries@aussietraveller.com.au | aussietraveller.com.au

BRISBANE SHOWROOM: 11-15 Oasis Court, Clontarf QLD 4019 | MELBOURNE SHOWROOM: 235 Barry Road, Campbellfield VIC 3061

SOG VENTILATION

The simple and highly effective solution to unwanted smells inside your caravan or motorhome - the SOG ventilation system.

The SOG Toilet Ventilation System is an ecological solution for motorhome and caravan toilets. It is 100% chemical free and 100% odourless.

Additives and chemicals are no longer necessary with the increased flow of oxygen guaranteeing optimal decomposition. Thanks to the lack of chemicals you will more freedom when travelling around Australia since you won't need a chemical dump point.

This system is available for all popular 12V Thetford and Dometic cassette toilets, as well as for permanent black water tanks. Choose from standard side, roof or floor venting models, all designed to match your existing cassette toilet.

Featuring a fast and powerful ventilator that immediately removes odours caused by suction. The ventilator is switched on as soon as the blade valve starts to open and is switched off again when the blade valve is closed. The exhaust ventilator with its motor has been specially designed for sanitary systems with its low power consumption, just 0.43W.

No smells can leave the waste holding tank as soon as the ventilator is switched on. There is a suction effect in the waste holding tank which draws in fresh air through the blade valve. This down-flow acts as a seal and prevents the gases and smells from rising. The fresh air that is drawn in removes the new odours in the toilet bowl when it is being used.

The SOG system does not require any special toilet paper, in fact ordinary toilet paper is recommended. The decomposition process for sewerage and toilet paper is accelerated by the increased flow of oxygen so that no additional chemicals are required.

Made with the traditional German engineering and know-how, this solution to a smelly problem will be an investment in quality of lifestyle.

FEATURES

- 100% chemical-free
- 100% odour-free
- Removes odour from the vehicle
- Fast & powerful ventilation system
- Optimal decomposition
- Low power consumption
- Works with ordinary toilet paper
- Suited to cassette toilets & black water tanks
- Can be retrofitted to existing Thetford toilet systems without the need for an auto-electrician

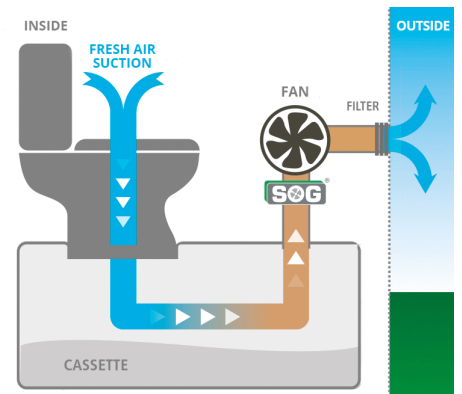

For full specifications and pricing see our website. For trade & wholesale pricing please speak to one of our sales reps.

GET IN TOUCH WITH OUR FRIENDLY TEAM

1300 663 868 | enquiries@aussietraveller.com.au | aussietraveller.com.au

BRISBANE SHOWROOM: 11-15 Oasis Court, Clontarf QLD 4019 | MELBOURNE SHOWROOM: 235 Barry Road, Campbellfield VIC 3061

SPECIFICATIONS

SOG DOOR VENT

- The ventilator is mounted directly inside the service hatch.
- The case containing the active charcoal filter is fitted on the exterior.
- The Door Vent SOG unit is the easiest to mount.
- The attractively designed plastic case is available in the colours white, light grey, dark grey and black and can also be painted the same colour as your vehicle.



SOG II FLOOR VENT

- The SOG®II offers the advantage that the filter cartridge can be stored in a wide variety of different locations in your camping vehicle and ventilated through the floor of the vehicle in any position (e.g. in the garage, under the seat, in the double floor or in the storage compartment).
- A hose or pipe extension (up to 3m away from the toilet) can be attached both in front of the compact system and to its floor outlet in order to find a suitable position.
- If you have a caravan in which your toilet's service hatch opens out into the awning, the SOG®II floor model is the ideal trouble-free solution for you.
- Can also be used in awning areas without any problems.
- No changes to the exterior wall of your recreational vehicle.



SOG ROOF VENT

- The roof vent model gives users the option of ventilating our SOG® systems through the roof. The waste holding tank is connected to the roof outlet by a pipe.
- The high-performance fan is installed directly under the roof outlet and provides sufficient negative pressure, even in the case of pipes that are up to 3m long.
- The roof ventilation system is maintenance free because no filter is needed.
- Given that some aspects of the retrofitting process are extremely complex, this model is mainly installed by manufacturers as original equipment.



CHACOAL FILTER

- An important constituent part of the SOG and SOG II is activated charcoal. This is made in a very environmentally-friendly way from organic materials such as peat, nutshells and sugar. This mainly consist of carbon (mostly >90%) with a highly porous structure.
- The pores are connected to one another as in a sponge (open-pored). Active charcoal is used as an adsorption material in, among other applications, the chemical and medical industries, for the treatment of water and waste water, and in ventilation and air conditioning systems.
- Ensure that the filter is changed regularly, after **ONE YEAR**, to avoid unpleasant smells from the vehicle.
- Long working life (1 year)
- Complete neutralisation of odours due to seamless processing
- No formation of charcoal dust
- Low weight & compact size



GET IN TOUCH WITH OUR FRIENDLY TEAM

1300 663 868 | enquiries@aussietraveller.com.au | aussietraveller.com.au

BRISBANE SHOWROOM: 11-15 Oasis Court, Clontarf QLD 4019 | MELBOURNE SHOWROOM: 235 Barry Road, Campbellfield VIC 3061

SPECIFICATIONS



SOG TYPE A

For all C2, C3 & C4

FLOOR VENT

PART NUMBER: 37000010000000

DOOR VENT - WHITE

PART NUMBER: 37000000000000



SOG TYPE B

For all Theotford C200

FLOOR VENT

PART NUMBER: 37100010000000

DOOR VENT - WHITE

PART NUMBER: 37100000000000

ROOF VENT

PART NUMBER: 37100000001000



SOG TYPE D

For Theotford C400 & C402

FLOOR VENT

PART NUMBER: 38300010000000

DOOR VENT - WHITE

PART NUMBER: 38300000000000



SOG TYPE F

For all Theotford C250

FLOOR VENT

PART NUMBER: 37400010000000

DOOR VENT - WHITE

PART NUMBER: 37400000000000

DOOR VENT - DARK GREY

PART NUMBER: 37400000000050



SOG TYPE H

For all Theotford C220

FLOOR VENT

PART NUMBER: 40500000001000

DOOR VENT - WHITE

PART NUMBER: 37700000000000



SOG TYPE 320S

For all Dometic Saneo Toilets

FLOOR VENT

PART NUMBER: 37600010000000

DOOR VENT - WHITE

PART NUMBER: 37600000000000



SOG TYPE 3000A

For all Dometic CT3000 & CT4000

FLOOR VENT

PART NUMBER: 37500010001000

DOOR VENT - WHITE

PART NUMBER: 37500000001000

DOOR VENT - DARK GREY

PART NUMBER: 37500000001050



SOG TYPE E

For Blackwater Tanks

ROOF VENT

PART NUMBER: 37200000000000

SOG CHARCOAL REPLACEMENT FLITERS



DOOR VENT

PART NUMBER: 37300000000000



FLOOR VENT

PART NUMBER: 85000000018000

GET IN TOUCH WITH OUR FRIENDLY TEAM

1300 663 868 | enquiries@aussietraveller.com.au | aussietraveller.com.au

BRISBANE SHOWROOM: 11-15 Oasis Court, Clontarf QLD 4019 | MELBOURNE SHOWROOM: 235 Barry Road, Campbellfield VIC 3061

NORTHSTAR RV WATER PUMPS

100%
FACTORY TESTED
& APPROVED

On demand safe for drinking water in your caravan, RV or camper trailer.

From trusted brand NorthStar® comes the new NSQ Series™ on-demand 12V fresh water pumps. High quality 12V Water Pumps specifically designed for the transfer of fresh water for caravans, mobile homes, camper trailers, food vans, coffee carts and more.

These fresh water diaphragm pumps provide extended life and performance with internal bypass, thermal protection, and no rapid cycling.

FEATURES

- Automatic shut-off when there is no flow to conserve battery power
- Quiet and efficient
- Self-priming design
- Designed for the RV & caravan industry
- Santoprene diaphragm
- 2 year warranty



**2060R FRESH WATER
12V DIAPHRAGM PUMP**
7.6L/per min



**3055R FRESH WATER
12V DIAPHRAGM PUMP**
11.L/per min



**5055R FRESH WATER
12V DIAPHRAGM PUMP**
18.9L/per min

For dimensions see next page.

For full specifications and pricing see our website. For trade & wholesale pricing please speak to one of our sales reps.

GET IN TOUCH WITH OUR FRIENDLY TEAM

1300 663 868 | enquiries@aussietraveller.com.au | aussietraveller.com.au

BRISBANE SHOWROOM: 11-15 Oasis Court, Clontarf QLD 4019 | MELBOURNE SHOWROOM: 235 Barry Road, Campbellfield VIC 3061

SPECIFICATIONS

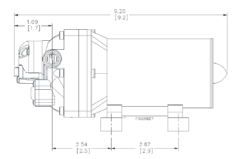
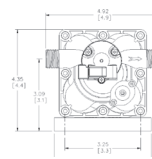
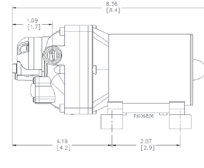
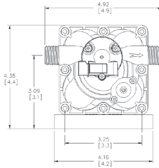
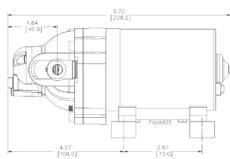
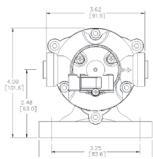

2060R FRESH WATER 12V DIAPHRAGM PUMP

PART NUMBER: 05100050001000

3055R FRESH WATER 12V DIAPHRAGM PUMP

PART NUMBER: 05100050002000

5055R FRESH WATER 12V DIAPHRAGM PUMP

PART NUMBER: 05100050003000

MODEL	2060R	3055R	5055R
MAX FLOW	7.6 Litres/min (2.0 gpm)	11.4 Litres/min (3.0 gpm)	18.9 Litres/min (5.0 gpm)
MAX PRESSURE	4.1 Bar (60 psi)	3.8 Bar (55 psi)	3.8 Bar (55 psi)
INTERNAL BYPASS	No	Yes	Yes
PORTS	3/4in. QC	1/2in. NPSM	1/2in. NPSM
LIFT/HEAD	2.4m (8ft)	3.0m (10ft)	3.0m (10ft)
LIQUID TEMPERATURE	55°C (130°F)	55°C (130°F)	55°C (130°F)
WEIGHT	2.27kg (5lbs)	2.50kg (5.5 lbs)	2.72kg (6.0 lbs)
DIMENSIONS	225x102x93mm (8.84x4.02x3.65in)	207x125x110mm (8.15x4.92x3.65in)	207x125x110mm (8.15x4.92x3.65in)
WETTED MATERIALS	Plastics: Polypropylene, Nylon Diaphragm: Santoprene Valves/Seats: EPDM Check Valve Spring: Stainless Steel		
APPROVALS/CERTS.	CE, NSF ANSI 61, CSA Z240.3.2 IPX1 Protection, IAPMO Class Type IV		

ADDITIONAL PARTS

DESCRIPTION	PART NUMBER
QC - 1/2" Hose Barb Straight Fit	05100050001010
QC - 1/2" Hose Barb Elbow Fit	05100050001020
QC - John Guest Straight Fit	05100050001030
QC - RV Pump Filter	05100050001040
NPSM - 1/2" Hose Barb Straight Fit	05100050004010
NPSM - 1/2" Hose Barb Elbow Fit	05100050004020
NPSM - John Guest Straight Fit	05100050004030
NPSM - RV Pump Filter	05100050004040

GET IN TOUCH WITH OUR FRIENDLY TEAM

1300 663 868 | enquiries@aussietraveller.com.au | aussietraveller.com.au

BRISBANE SHOWROOM: 11-15 Oasis Court, Clontarf QLD 4019 | MELBOURNE SHOWROOM: 235 Barry Road, Campbellfield VIC 3061

RV & MOTORHOME RANGEHOODS

Remove any unwanted odours and fumes from your kitchen quickly and efficiently.

Aussie Traveller introduces our first range of RV Rangehoods suited to the caravan and motorhome industry. With 3 models to choose from, there is a rangehood to suit your application.

The front panel surface mount rangehoods are available in two sizes, standard 530mm wide or the compact space saving 380mm wide models. Both feature tempered glass touch control face, digital display, 3 speed twin extractor fans, washable filter, twin LED lights, stainless steel body with rear or top air outlet. Our 380mm version is perfect for the smaller kitchenette within any RV.

The flush mount version comes with a 465mm wide body, easy-access tempered glass touch control front display, digital display, 3 speed extractor fan, washable filter, twin LED strip lights, stainless steel body and rear air outlet.

All the Aussie Traveller Rangehoods come with a 12 month warranty, full range of spare parts and are easy to install.

For dimensions, please see next page.

FEATURES

- Tempered glass touch control panels
- Digital displays
- Twin LED lights
- Stainless steel body
- 3 speed extractor fans
- Washable filters
- 12 month warranty



RANGEHOOD 465MM INTEGRATED FLUSH MOUNT 12V WITH GLASS FASCIA



RANGEHOOD 530MM SURFACE MOUNT 12V WITH GLASS FASCIA



RANGEHOOD 380MM SURFACE MOUNT 12V WITH GLASS FASCIA



WARNING

Contains Button or Coin Cell Battery . Hazardous if swallowed—see instructions .

For full specifications and pricing see our website. For trade & wholesale pricing please speak to one of our sales reps.

GET IN TOUCH WITH OUR FRIENDLY TEAM

1300 663 868 | enquiries@aussietraveller.com.au | aussietraveller.com.au

BRISBANE SHOWROOM: 11-15 Oasis Court, Clontarf QLD 4019 | MELBOURNE SHOWROOM: 235 Barry Road, Campbellfield VIC 3061

SPECIFICATIONS

RANGEHOOD INTEGRATED 465MM 12V WITH GLASS FASCIA

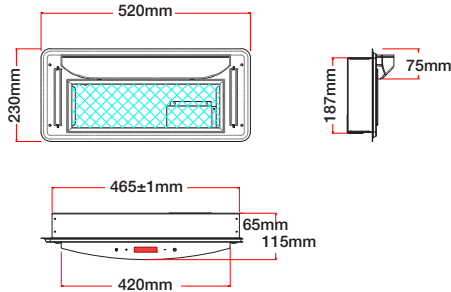

RANGEHOOD 530MM 12V WITH GLASS FASCIA

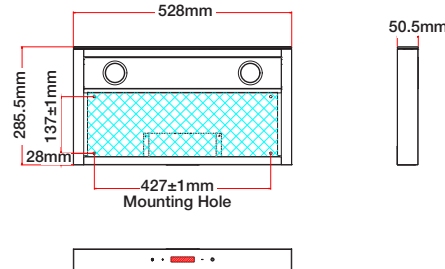

RANGEHOOD 380MM 12V WITH GLASS FASCIA

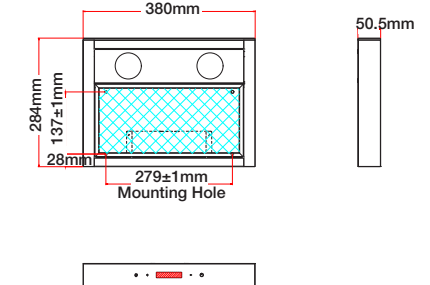

PART NUMBER	56000010003000
MOUNT	Flush Mount
WIDTH (mm)	520
HEIGHT (mm)	115
DEPTH (mm)	230

PART NUMBER	56000010001000
MOUNT	Surface Mount
WIDTH (mm)	528
HEIGHT (mm)	50.5
DEPTH (mm)	285.5

PART NUMBER	56000010002000
MOUNT	Surface Mount
WIDTH (mm)	380
HEIGHT (mm)	50.5
DEPTH (mm)	284

ADDITIONAL PARTS

DESCRIPTION	ITEM CODE
AT Rangehood Rear Vent	56000010004000
AT Rangehood Filter - Suit 530mm	56000010001010
AT Rangehood Filter - Suit 380mm	56000010002010
AT Rangehood Filter - Suit 465mm	56000010003010
AT Rangehood Fan - Suit 530mm	56000010001020
AT Rangehood Fan - Suit 380mm	56000010002020
AT Rangehood Fan - Suit 465mm	56000010003020

For full specifications and pricing see our website. For trade & wholesale pricing please speak to one of our sales reps.

GET IN TOUCH WITH OUR FRIENDLY TEAM

1300 663 868 | enquiries@aussietraveller.com.au | aussietraveller.com.au

BRISBANE SHOWROOM: 11-15 Oasis Court, Clontarf QLD 4019 | MELBOURNE SHOWROOM: 235 Barry Road, Campbellfield VIC 3061

PICNIC TABLE



Aussie Traveller is helping to make your holiday stays easier to manage with the wall mounted Picnic Tables.

Quick and easy to install, these Picnic Tables can be fitted to any side wall of a caravan, RV or Motorhome using a composite panel construction.

Light weight, weighing only 4.5kg and made from UV resistant ABS material, these tables also feature thickened high-quality stainless-steel hinges, high temperature resistant aluminium alloy bearing plate, dual key locks with central opening stainless-steel handle, and a one-piece outer frame moulding design. This one-piece design available in white or black, offers added strength and no gaps or joins on the frame.

The Aussie Traveller Picnic Tables also come with twin 12V LED strip lights within the frame controlled by a central on/off button. Smart, stylish, durable and easy to install.



PICNIC TABLE - WHITE

PART NUMBER: 05100090008000

PICNIC TABLE - BLACK

PART NUMBER: 05100090007000

FEATURES

- Easy to install with self-tapper screws
- Twin 12V LED lights
- Stylish & durable
- 2 chrome locks with 2 keys
- Available in white or black
- Open back design suits most flat wall composite caravans
- White or Black backing plate sold separately.

DIMENSIONS

Closed (WxHxD)
800mm x 450 x 26.5mm

Open Tray (WxHxD)
714 x 450 x 319.5mm

For full specifications and pricing see our website. For trade & wholesale pricing please speak to one of our sales reps.

GET IN TOUCH WITH OUR FRIENDLY TEAM

1300 663 868 | enquiries@aussietraveller.com.au | aussietraveller.com.au

BRISBANE SHOWROOM: 11-15 Oasis Court, Clontarf QLD 4019 | MELBOURNE SHOWROOM: 235 Barry Road, Campbellfield VIC 3061

TRAVELCLOUD CARAVAN MATTRESS

The TravelCloud mattress combines the support you need with the comfort of resting on a cloud for a perfect nights sleep.

The TravelCloud mattresses are high quality, pillow-top or standard mattresses with styles with a removable zip bolster or no bolster, bonnell springs, 3cm high density, soft foam to create the pillowtop, 400g cotton padding with a strong side boarder to ensure that mattress won't collapse like other caravan mattresses.

Specifically designed with the traveller in mind, the bed base features a retractable bed base end that offers extra leg room when fully extended, strong birch wood bed slats, 4 piece hinge and two 450nM bed struts.

The combination of the Aussie Traveller bed base and TravelCloud mattress will make travelling a joy.

FEATURES

- Luxury support and comfort
- High density soft foam pillow-top
- Breathable quilted fabric
- Removable pillow top bolster style
- Standard and pillow top styles without bolster also available
- Hinged and retractable bed base
- Extends for extra leg room
- Spacious RV queen size
- Bed base struts sold separately
- Full range of bed base spare parts also available
- 5 year warranty (*on mattress only*)



Extends for extra leg room.



Removable pillow-top bolster style.

For full specifications and pricing see our website. For trade & wholesale pricing please speak to one of our sales reps.

GET IN TOUCH WITH OUR FRIENDLY TEAM

1300 663 868 | enquiries@aussietraveller.com.au | aussietraveller.com.au

BRISBANE SHOWROOM: 11-15 Oasis Court, Clontarf QLD 4019 | MELBOURNE SHOWROOM: 235 Barry Road, Campbellfield VIC 3061

SPECIFICATIONS



TRAVELCLOUD PILLOWTOP BOLSTER RV QUEEN MATTRESS
PART NUMBER: 27018801520000



TRAVELCLOUD PILLOWTOP NO BOLSTER RV QUEEN MATTRESS
PART NUMBER: 27218801520000



TRAVELCLOUD STANDARD NO BOLSTER RV QUEEN MATTRESS
PART NUMBER: 27118801520000

TRAVELCLOUD RV QUEEN MATTRESS			
STYLE	PILLOWTOP BOLSTER	PILLOWTOP NO BOLSTER	STANDARD NO BOLSTER
PILLOW TOP	3cm 30 density soft foam	3cm 30 density soft foam	3cm 30 density soft foam
PADDING	400g cotton pading	400g cotton pading	400g cotton pading
SPRING SYSTEM	17cm height dia.2.2mm bonnell spring	17cm height dia.2.2mm bonnell spring	17cm height dia.2.2mm bonnell spring
PADDING	400g cotton padding	400g cotton padding	400g cotton padding
QUILTING FOR BOTTOM	0.8cm 20 density compressed foam	0.8cm 20 density compressed foam	0.8cm 20 density compressed foam
QUILTING	knitted fabric	knitted fabric	knitted fabric
SIDE BORDER	0.8cm 20 density compressed foam	0.8cm 20 density compressed foam	0.8cm 20 density compressed foam
LENGTH	1880mm	1880mm	1880mm
WIDTH	1525mm	1525mm	1525mm
HEIGHT	230mm	230mm	200mm
BOLSTER SIZE	200x1525x230mm	N/A	N/A



RV QUEEN BED BASE
PART NUMBER: 27015151420000



RV BED BASE STRUT
PART NUMBER: 27000000450000

PLEASE NOTE:

- Base struts are sold individually, if you require one per side, you will need to order 2.

RV BED BASE	
OVERALL WIDTH	1515mm
CLOSED LENGTH	1420mm
OVERALL LENGTH	1745mm
FRAME TUBE WIDTH	30mm with 50mm support plate
EXTENSION TUBE WIDTH	20mm
SLAT WIDTH	50mm
SLAT LENGTH	700mm
EXTENSION RADIUS	70mm to 325mm centre
EXTENSION HEIGHT	215mm
HINGE POINTS	4
BRACE POINTS	140mm
EXTENSION HANDLE	Yes
GAS STRUTS	2 – 450Nm with base plate

GET IN TOUCH WITH OUR FRIENDLY TEAM

1300 663 868 | enquiries@aussietraveller.com.au | aussietraveller.com.au

BRISBANE SHOWROOM: 11-15 Oasis Court, Clontarf QLD 4019 | MELBOURNE SHOWROOM: 235 Barry Road, Campbellfield VIC 3061

ROOF HATCHES



Bring light and fresh air into your caravan or RV with Aussie Traveller's range of bathroom and skylight roof hatches.

Aussie Traveller's range of Roof Hatches are designed with European style in mind. The high-quality you know Aussie Traveller supplies is evident in all the shower hatch models and skylight models.

With a range of 4 sizes available, Aussie Traveller will offer popular sizes required in the RV industry. The range also features CE Certificate of Conformity and additional TUV Rheinland REACH test certifications.

FEATURES

- European high quality & design
- Sleek white interior frame colour
- LED interior lights on 320 x 320mm, 450 x 400mm & 700 x 500mm models
- LED touch sensor HALO LED light on 400 x 400mm model
- UV resistant, double glazed smoke black tinted windows on skylights
- All models suit roof sizes of 25-60mm
- 400 x 400mm model suit roof size overall max. height of 50mm
- 280 x 280mm Turbo hatch features a 12V Reverse Fan

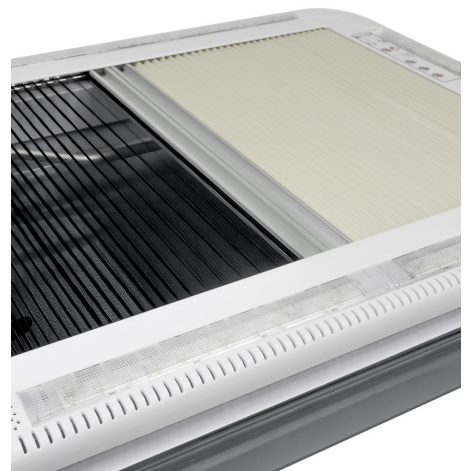

MODEL	PART NUMBER
280x280mm Shower & Bathroom Turbo Roof Shower Hatch	41302800280020
320x320mm Shower & Bathroom Turbo Roof Shower Hatch with LED Lights	41303200320020
400x400mm Skylight Smoke Black Lid Roof Hatch	41304000400080
450x400mm Skylight Smoke Black Lid Roof Hatch	41304500400080
700x500mm Skylight Smoke Black Lid Roof Hatch	41307000500080

For full specifications and pricing see our website. For trade & wholesale pricing please speak to one of our sales reps.

GET IN TOUCH WITH OUR FRIENDLY TEAM

1300 663 868 | enquiries@aussietraveller.com.au | aussietraveller.com.au

BRISBANE SHOWROOM: 11-15 Oasis Court, Clontarf QLD 4019 | MELBOURNE SHOWROOM: 235 Barry Road, Campbellfield VIC 3061

SHOWER & BATHROOM HATCHES

- Sizes: 280 × 280mm and 320 × 320mm.
- Features a solid white ASA material lid, white interior frame, fixed flyscreen, manual roof lid opening, two ways forward and reverse air flow fan.
- The 280 × 280mm provides 70sq centimetres of permanent fixed ventilation, while the 320 × 320 provides 80sq centimetres of permanent fixed ventilation.
- The 320 × 320mm model features 12-volt power input with LED interior lights as standard.



280 × 280 TURBO ROOF SHOWER HATCH

PART NUMBER: 41302800280020

320 × 320 TURBO ROOF SHOWER HATCH

PART NUMBER: 41303200320020

SKYLIGHT HATCHES

- Sizes: 400 × 400mm, 450 × 400mm and 700 × 500mm.
- Featuring double-glazed smoke black tint roofs with manual 4 position open and close — including ventilation and locked positions, roof lid handles with push button locking for added safety and standard pleated blind and flyscreen.
- The 400 × 400mm includes 3 light modes from the 12Volt halo LED light and unique touch sensor.
- The interior seal on the 400 × 400mm model can be removed to provide 100sq centimetres of permanent fixed ventilation.
- The 450 × 400mm and 700 × 500mm models combine all the best features of the full range of roof hatches and includes a large opening area, 4 x 12Volt LED perimeter lights and with 150sq centimetres of permanent fixed ventilation.



400 × 400 SMOKE BLACK LID SKYLIGHT ROOF HATCH

PART NUMBER: 41304000400080

450 × 400 SMOKE BLACK LID SKYLIGHT ROOF HATCH

PART NUMBER: 41304500400080

700 × 500 SMOKE BLACK LID SKYLIGHT ROOF HATCH

PART NUMBER: 41307000500080

GET IN TOUCH WITH OUR FRIENDLY TEAM

1300 663 868 | enquiries@aussietraveller.com.au | aussietraveller.com.au

BRISBANE SHOWROOM: 11-15 Oasis Court, Clontarf QLD 4019 | MELBOURNE SHOWROOM: 235 Barry Road, Campbellfield VIC 3061



THULE ROOF VENTS

Thule Vents provide a practical solution for fresh air and ventilation as an ideal alternative to an air-conditioner.

The aerodynamic design for the Thule Vents means you no longer need a spoiler on your vehicle.

On both manual and electric operations, the roof light is mounted with special clamps so drilling is not needed, except for the opening itself. These Thule Vents come with a blackout roller blind and an easy to clean, removable mosquito screen as standard.

The Thule Vents are available in White or Translucent colourways to give maximum light to the interior of your caravan. Featuring a white roller blind that can be rolled up in 3 phases, set inside a cream inner frame. All Thule Vents have quick and easy clamp style fitting.

The Manual models can be easily upgraded to the Electric models at a later date with the addition of the 12V Ventilator.

The Electric 12V model combines the Thule Vent with a motorised ventilator to provide fresh air and ventilation instantly. A simple press on the button of the control panel adjusts the speed and rotation direction. Plus, it is silent and extremely low on energy consumption. Maximum ventilation is 20m³/min.

On the Electric models in addition to 12 adjustable ventilation speeds, the Thule Vent has an energy-saving function, a boost function and a safety mechanism to guard against excess voltage, incorrect connection and blockage. It also features a touch control panel with LED indication. The ventilator boost function returns to its original speed after 5 minutes is ideal in toilets or bathrooms.

FEATURES

- Easy installation without drilling
- Aerodynamic shape
- All materials are made of impact and weather-resistant plastics
- Adjustable ventilator speed on electric models
- Roof thickness: 25–40mm, 40–60mm with additional fitting kit

SPECIFICATIONS

Manual:

Dimensions outside: 472 x 459mm
Dimensions inside: 400 x 400mm
Height (closed): 78mm
Max Opening Angle: 40°
Weight: 3kg

Electric:

Dimensions outside: 472 x 459mm
Dimensions inside: 400 x 400mm
Height (closed): 78mm
Max Opening: Angle 40°
Weight: 4.5kg

Ventilator (Electric Only):

Power Consumption: 0.17A – 3A
Max Air Flow: 20m³/min
Diameter: 300mm

For full specifications and pricing see our website. For trade & wholesale pricing please speak to one of our sales reps.

GET IN TOUCH WITH OUR FRIENDLY TEAM

1300 663 868 | enquiries@aussietraveller.com.au | aussietraveller.com.au

BRISBANE SHOWROOM: 11-15 Oasis Court, Clontarf QLD 4019 | MELBOURNE SHOWROOM: 235 Barry Road, Campbellfield VIC 3061

12V ELECTRIC VENTS

**THULE ROOF VENT
ELECTRIC WHITE**

PART NUMBER: 41200000000320

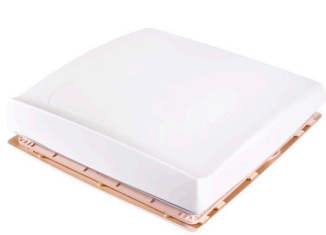

**THULE ROOF VENT
ELECTRIC TRANSLUCENT**

PART NUMBER: 41200000000340

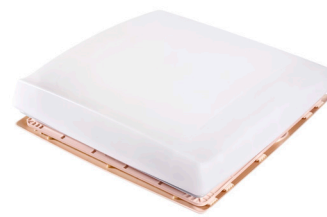

MANUAL VENTS

**THULE ROOF VENT
MANUAL WHITE**

PART NUMBER: 41000000000320

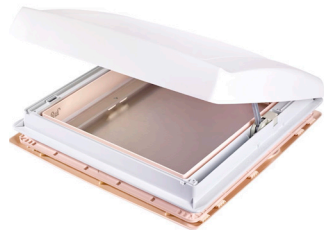
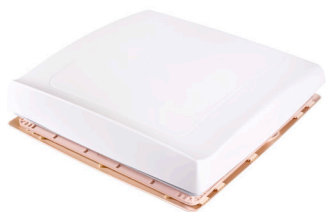

**THULE ROOF VENT
MANUAL TRANSLUCENT**

PART NUMBER: 41100000000340

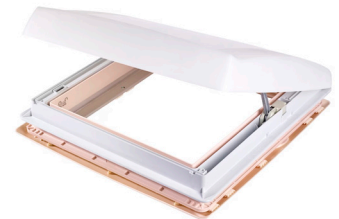
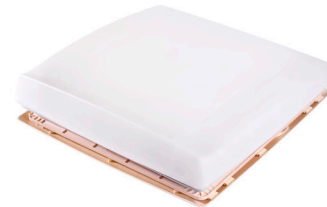

**THULE ROOF VENT
12V VENTILATOR KIT**

PART NUMBER: 84100000011000



GET IN TOUCH WITH OUR FRIENDLY TEAM

1300 663 868 | enquiries@aussietraveller.com.au | aussietraveller.com.au

BRISBANE SHOWROOM: 11-15 Oasis Court, Clontarf QLD 4019 | **MELBOURNE SHOWROOM:** 235 Barry Road, Campbellfield VIC 3061