

KAHUNA  CHAIR®

KAHUNA MASSAGE CHAIR

HM5000

MANUAL





CONTENTS



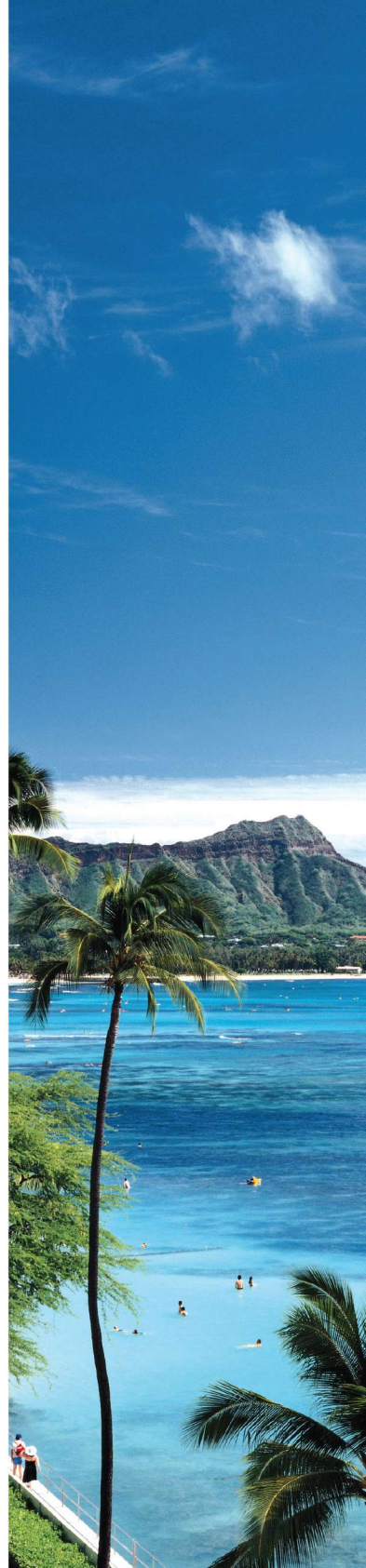

Please read and follow all safety instructions listed in this user manual prior to use. Basic precautions should always be considered when operating an electrical appliance.

Safety Instructions	2
Product Components	7
Chair Installation	8
Remote Controller	11
Operation Guide	12
Maintenance	19
Troubleshooting	20
Product Specifications	21
Warranty card	22



- Please read this manual carefully to make sure the installation and operation of the massage chair is done correctly.
- “Safety Instructions” are provided for important safety information. Both Warning and Caution are important safety caution, please be more cautious.

	Warning	This sign indicates warning of causing possible death or injury to body.
	Caution	This sign indicates caution of causing possible pain or damage to body.

	This sign indicates forbidden behavior.
	This sign indicates must follow instruction to operate.
	This sign indicates self disassembly is forbidden.
	This sign indicates correct operation of cable.

- The following should be kept for any further references.

SAFETY INSTRUCTION



Warning

	<ul style="list-style-type: none"> • Osteoporosis patient ; • People with heart disease including embedded pacemaker or other medical electronic device inside the body ; • For pregnant women or people with health issues, please consult with doctor before use ; • Patients with a high fever forbid to use this machine. • Perceptual disabilities patients forbid to use this machine. • People over 80 years old forbid to use this machine. • Kids are not allowed to use the chair ; • Don't operate the chair after the use of alcohol. • Please don't sleep in the chair. • Don't use the chair when your body is wet. 	<p>People who are not suitable to use the chair</p>
	<ul style="list-style-type: none"> • Make sure there are no kids or pets or other objects around (under, behind or in front of) the chair at the moment of backrest, leg-rest up/down or leg-rest retraction/extension from reclining position. • During operation, if body is being abnormal, please stop the operation and go consult with your physician. • Please do not take strong massage on the head. • Do not massage belly or knees, be careful when massaging neck. • Children or pets are not allowed to play on the chair especially during massage. Standing or sitting on the back or armrest is not allowed either. • Those who move around with difficulty or can't express themselves must be taken care of strictly and continuously during massage. 	<p>Accident /injury</p>
	<ul style="list-style-type: none"> • Insert the plug of the chair into correct and suitable power socket. • Make sure the plug is completely inserted into the socket to reduce short circuit or fire risk. • Unplug the power when not in use, stop all massage functions and turn off on/off key before unplugging. 	<p>Fire and electric shock</p>
	<ul style="list-style-type: none"> • Massage cushions of the chair are not allowed to fold for storage. • The machine is forbidden for no-load running for a long time. 	<p>Accident</p>
	<ul style="list-style-type: none"> • Power cord, plug, socket can't be used in broken or loose contact condition. • Don't use other electric power except rated voltage in case of fire, electric shock or any breakdown. • Any broken, re-process, knotted, twisted power cord or pressed under heavy gage is not allowed to use. 	<p>Fire and electric shock</p>





Warning

	<ul style="list-style-type: none"> If the chair is dysfunctional, or is broken, splashed with water or falls into water, please have it repaired by professional repairman or send the chair to assigned service agent. Self-modification, disassembly or maintenance is forbidden. If power cord or plug is damaged, please don't replace it yourself, please contact us or appointed dealer for replacement. To avoid electric shock or body injury, please don't open or disassemble any part of the chair, there is not any attached part of the chair for maintenance by customers. Check leather or cloth material on the back and other areas is broken or not. If broken, even though it is small, please stop using the chair, unplug the power and have it repaired. 	Disassembly and maintenance
--	--	-----------------------------







Caution

	<ul style="list-style-type: none"> Please operate the chair when it is flat or on leveled place Position the chair 4 inches from the wall to allow for sufficient space to recline up and down. The maximum suggested operating time is 20 mins. 5 mins for each position beginning with the slight- step massage. Along continuous massage in the same position may cause uncomfortable feeling. Before sitting on the chair to avoid injury please inspect everything to confirm that the massage heads are in the correct position. Please make sure that the power switch is on "OFF" position before inserting the plug into the socket. Turn off all controls before removing plug from outlet. Make sure the plug is completely inserted into the socket. Checking whether there are any damages on the wire and make sure there are no water or rubbish on the wire. Installing the wire in a correct way. The plug must be inserted into socket with  the connect, the connect couldn't be bent or cut off.  	To avoid sudden falling. To make sure the back lying. Too long time massage is bad for your body. To avoid accidental injury. To avoid the accident when turn on the power. To reduce short circuits and any fire hazard. To avoid electric shock in any leakage or breakdown.
	<ul style="list-style-type: none"> Don't use or store the chair in the wet environment like near the swimming pool, or bathroom. Keep the chair and remote control dry at all time. Don't use the chair when your body is wet. 	To avoid leakage or electric shock.

SAFETY INSTRUCTION

Caution

	<ul style="list-style-type: none"> • Don't press with hands or step on the massage heads with feet. • Don't put hands between the working massage heads. Don't put hands or feet in the gap of mechanical parts. Don't drop or insert anything into the slot of massage chair. • Don't stand or sit or put anything on the backrest, armrest, or leg-rest. • Don't stand on the chair during operation. Don't move the chair during operation. • Don't pull out the plug or turn off the power during operation. Don't put your hands or head between leg-rest or beneath. Don't use the massage chair while wearing hair ornaments. Don't put hard things in pocket when take buttocks and huckle massage. • Don't sit or press on the backrest when the chair is in reclining position. • Don't use on bare skin or wearing thin clothes, thin clothes may cause better massage effect, But it also may cause irritation to the skin or cryogenic burns. 	<p>To avoid accidents or injury</p>
	<ul style="list-style-type: none"> • Keep the chair away from heat, wet, sharp things and corrosive, inflammable, explosive environment. • To use electric blanket or other heating products on the chair is forbidden. • Don't put in the space of dust serious or corrosive gas environment. • Don't put the chair in a small space places or use in the bad air circulation places. 	<p>To avoid fade, discolor on upholstery or hardened, deteriorated on PU.</p>
	<ul style="list-style-type: none"> • Keep the chair away from stove or other heating products. • Don't put the chair directly under the sun or other high temperature places. • Don't use the chair in outdoor. 	<p>To avoid electric shock.</p>
	<ul style="list-style-type: none"> • Make sure to install the wire in correct way(Incorrect install way may cause electric shock. If you don't know how to install, please find a professional electrician) • Don't use plug adapter (If the enclosed plug doesn't match with socket, please don't change the plug by yourself and find a professional electrician to install a matched socket.) 	<p>To avoid electric shock.</p>

Caution

	<ul style="list-style-type: none"> • Unplug the power before cleaning the chair. • Unplug the power after using the chair. 	To avoid electric shock or fire hazard.
	<ul style="list-style-type: none"> • Unplug the power when any damage on the power. 	
	<ul style="list-style-type: none"> • Hold the plug to unplug the power but to not try to pull the wire to unplug the power. 	To avoid accidents
	<ul style="list-style-type: none"> • Please turn off the power switch and unplug the power after massage. 	
	<ul style="list-style-type: none"> • Unplug the power immediately when electricity goes off. 	



- Warning :**
1. Do not use it when wet.
 2. The disabled may need supervision.
 3. The chair has heat function, people who are insensitive to heat must pay high attention.

| Grounding instruction |

The chair is equipped with a cord having a grounding conductor. The plug must be plugged into an appropriate socket that is properly installed and matched with the plug.



Earth wire is not allowed to be in these places

Gas pipe: probably cause explosion or fire.
 Phone wire and lightning rod: probably cause electric shock and fire when thundering.
 Water pipe: earth wire is useless where there are plastics

PRODUCT COMPONENTS

| Main body diagram (Front) |

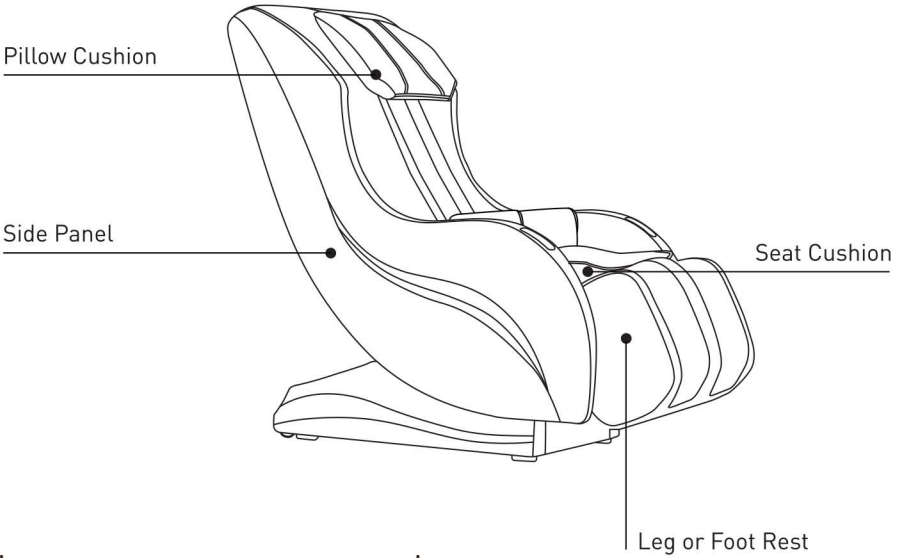

| Main body diagram (Rear) |

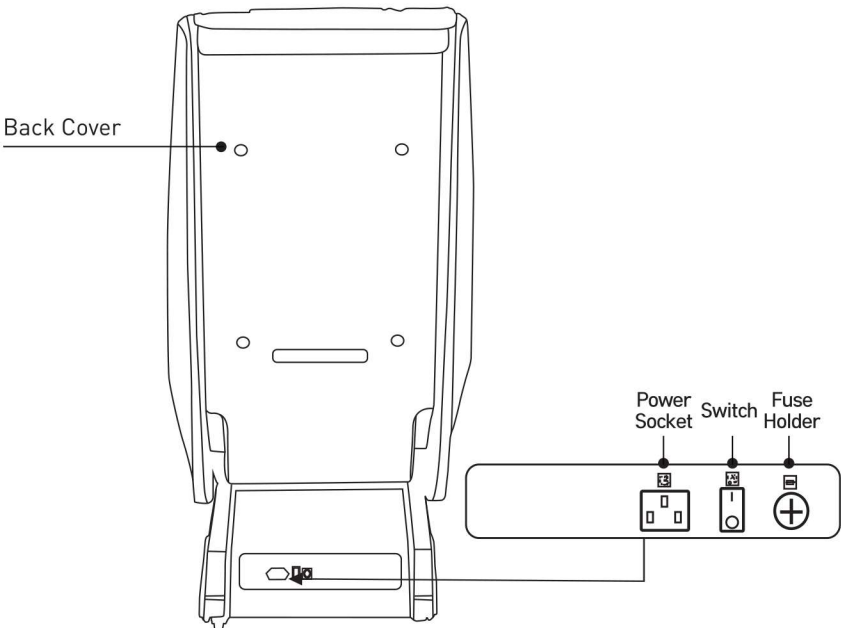

| 1. Unpack |

Unpack the carton box, take out the accessory box, and carry out the massage chair main body (Due to its heavy weight, we suggest at least two person working together to carry it). Then place it in a proper place. When placing the chair, make sure there is enough space for the chair to operate.



Main Box



Accessory Box

| 2. Reset the chair |

Left down the leg massager.

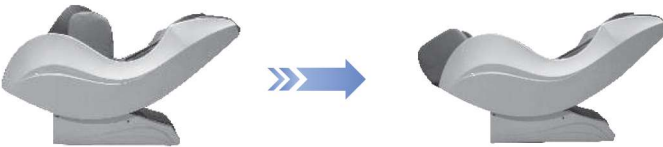

Connect the power cord, turn on the switch in the lower back, press the power button for twice, the chair will reset automatically within 30 seconds.

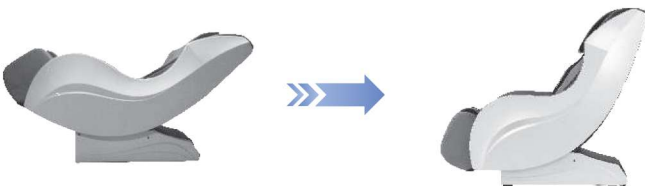

Zip up the back cushion with backrest frame, flatten the leg massager cover piece.

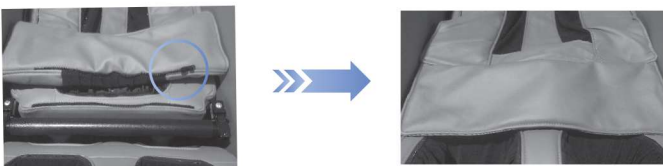

CHAIR INSTALLATION

2. Moving the massage chair

After completing the installation, put the chair in incline / upright position to move the chair easily.

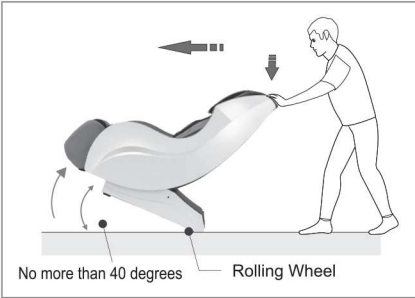

- As illustrated, tilt the chair back onto its wheels at 40° angle. Slowly push and maneuver the massage chair to desired location. Lower massage chair slowly and smoothly until it is fully flat on the ground.

3. Place the massage chair in an open area

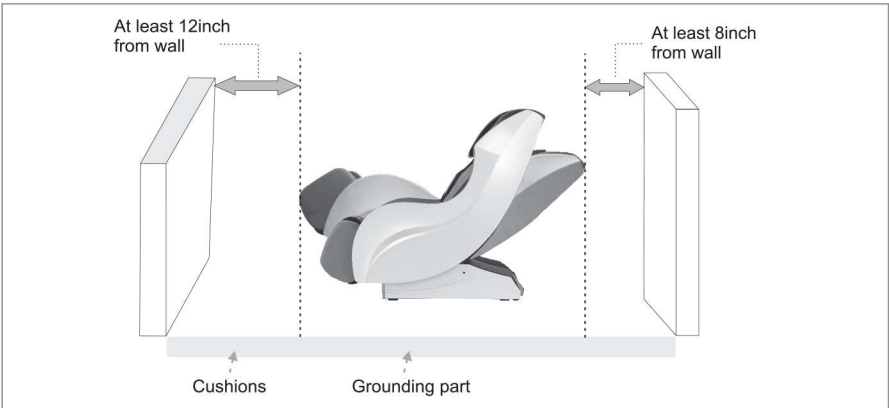

Because the chair is heavy, it may ruin your floor in long time setting. Please put a blanket or other soft things to protect your floor.

CAUTION

- * Don't use the chair in wet places like near swimming pool , bath room to avoid leakage or electric shock.
- * Please use chair in flat place to avoid chair falling or noise or other unexpected trouble.
- * Don't use under sunlight or near stove or other heating place to avoid upholstery deteriorated.

| Control panel |



Power: Turn on/off the chair

-When the chair is in the reset position and has been connected to a power source, press this button will turn on the chair (You need to press it for twice for the first time after connecting to the power source); When the chair is working, press this button will turn off and reset the chair.

-The chair will start with the body scan, and if the user doesn't make any operation, it will switch to the default full body massage program.

-When the massage session is finished, the chair will keep in the reclined angle, to reset it, press the power button.



Pause: When the chair is working, press this button, all functions will be suspended, press it again, all functions will resume.



Switch: Switch among full body programs

-This chair contains 6 full body programs, you can select from them circularly by pressing this button.



Backrest up: Hold this button will lift up the backrest.



Backrest down: Hold this button will lift down the backrest.



USB:USB port - You can use it to charge your mobile device.

REMOTE CONTROLLER

| Remote Controller |



1. LCD
2. On/Off Massage chair
3. Menu button
4. Pause/Emergency stop
5. Direction button
6. Manual massage button
7. Up button
8. Down button
9. Zero gravity
10. Automatic massage button
11. Shoulder adjustment button
12. Massage areas button
13. Speed button

Function description of controller buttons



Power: Turn on/off the chair
 -Press this button the chair will start to work (for the first time after the chair connected to power source, you need to press twice to turn on the chair.)
 -When the chair is working, press this button will turn off the chair, and reset its angle.



Pause: When the chair is working, press this button, all functions will be suspended, press it again, all functions will recover.



Menu: Press this button to enter the menu if you are in the home screen; if you are in the menu, press this button will switch to home screen.



Adjust shoulder height: The back roller will adjust its travel height according to the user's body height. These two buttons are for adjusting the height set after body scanning, so it could be more accurate.



Full body program switch: This chair has 6 full body program, you can switch among them by press this button.



Direction buttons

Up/down button: In the home screen, if the back roller is in the focus/partial massage mode, press this button can adjust the back roller position; in the menu, press this button to select, and press OK to confirm your selection.

Right/Left button: Adjust the extended length of the massage roller arms by pressing and holding these two buttons.



Zero gravity: Press this button to enter the zero gravity position, and the zero icon on the home screen will light up. If you adjust the leg massager or backrest angle after in zero gravity position, the zero icon will turn grey, and the chair will out of zero gravity position.



Switch the 3 kinds of massage areas by press this button.



Switch the massage roller speed by press this button.

OPERATION GUIDE



Lift up the backrest:Lift up the backrest by holding this button.



Lift down the backrest:Lift down the backrest by holding this buttons.



Switch the 6 kinds of massage methods by press this button.



| Display diagram |

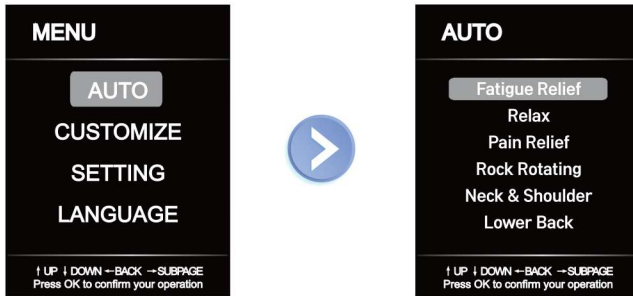

- **Fatigue Relief:** This is the default program of the chair, It helps the user to get recover from fatigue or stress. The chair will automatically switch to this program if the user doesn't perform any operation after booting the chair.
- **Relax:** This program is prepared for new users or users who prefer a less intensity massage. The massage experience of this program is softer than others.
- **Pain Relief:** This program helps users to relieve pain, stiffness and other discomfort by offering deep massage.
- **Rock Rotating:** In addition to the comprehensive body massage, this program belong users to fall asleep quickly through a slow and rhythmic rotation. Designed for those who want to take a short break in the massage chair.
- **Neck & Shoulder:** Full body massage program which has a higher massage frequency in the neck and shoulder area.
- **Lower Back:** Full body massage program which has a higher massage frequency in the lower back area.

Customize

The customize offers multiple options for adjusting the chair to meet your preferences. Press UP/DOWN arrow to select, and press OK to confirm selection. Press the Left arrow to get back.

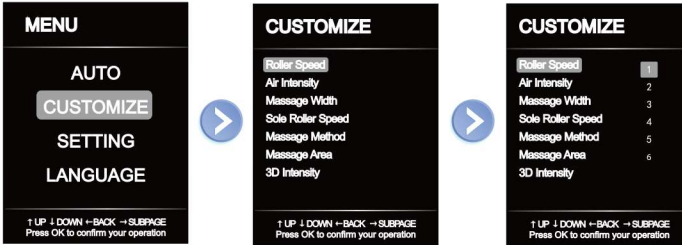

- **Roller speed:** Adjust the massage speed of the back roller. The back roller speed has 6 levels for option, 1 is the lowest, and 6 is highest.

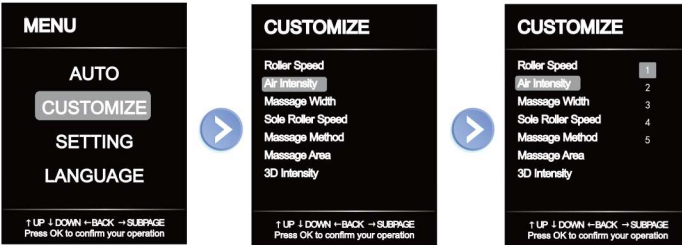

- **Air intensity:** Adjust the air bag intensity of the massage chair. The air bag intensity has 5 levels for option, 1 is the lowest, and 5 is the highest.

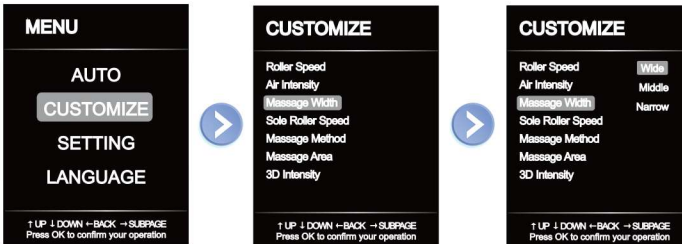

- **Message width:** Adjust the air bag intensity of the massage chair. The air bag intensity has 5 levels for option, 1 is the lowest, and 5 is the highest.

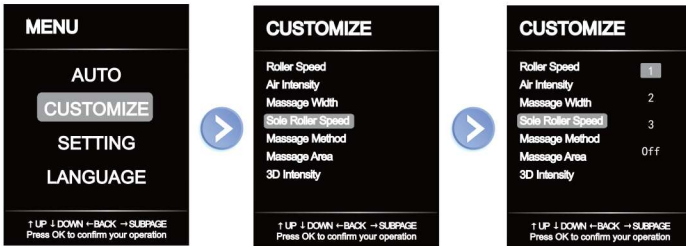

- **Sole roller speed:** Adjust the massage speed of the sole roller. The sole roller speed has 3 levels, and you can also turn it off in this menu.

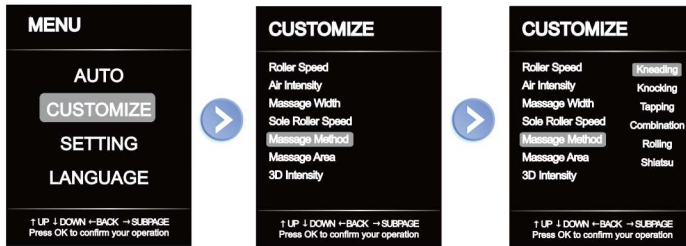

- **Message method:** The back roller has 6 different massage method, and they will appear alternately in automatic mode. If you want to choose only one method, you can choose under this menu.

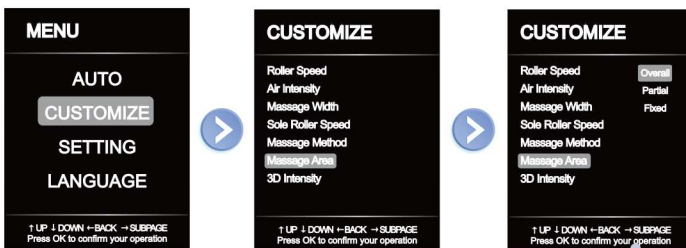

- **Message area:** Choose the massage area of the back roller. It offers 3 options: Overall allows the back roller to massage from top to buttons; Partial will make the roller going up and down in a certain area; and focus will keep the roller massage in a certain point.

OPERATION GUIDE

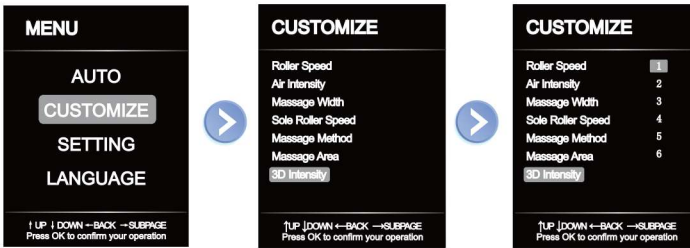

- **3D roller adjustment:** To adjust the extended length of the massage arms.

| 3 After use |

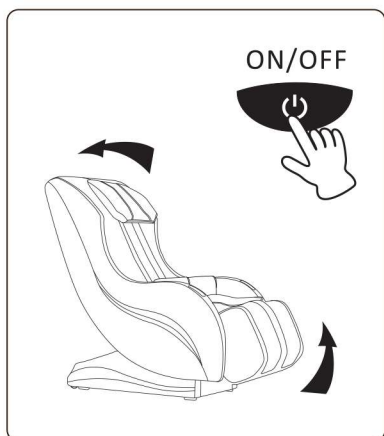

1. After the massage program is completed return the massage chair to upright position by turning off the massage chair.

Please check the surrounding prior to adjust the recline angle, paying special attention to children or pets that may be in close proximity.

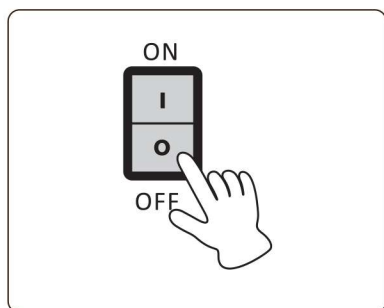

2. Press the power button to power off the massage chair and return remote controller to the storage area on arm pocket.

3. Turn off main power switch when you are not using the chair for a long period of time. Remove Plug from the power outlet to avoid accidents by kids and pets.

4. Do not operate with wet hands.

MAINTENANCE

| Use dry cloth to clean |

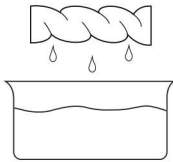
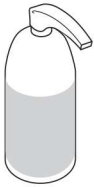
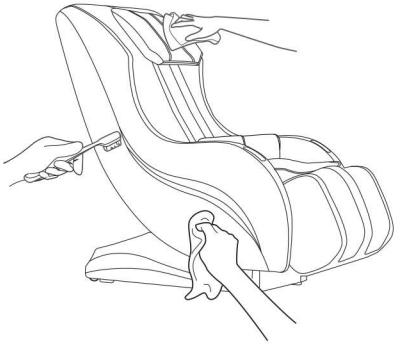

Turn off and pull out the plug before cleaning the massage chair, do not touch the plug with wet hands.

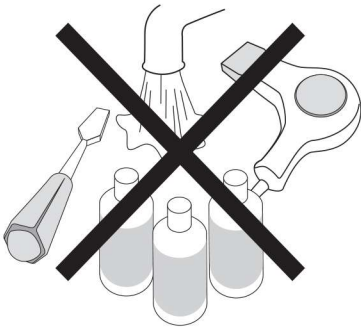

Prohibit using liquid cleaning products like water, alcohol, or other cleaning product to maintain a good quality.

TROUBLE SHOOTING

If the sounds or movements are not normal, please turn off the massage chair and remove the plug from the electric outlet. Please contact the customer service department for further assistance.

855.646.9500 / 1.714.388.2625, service@kahunachair.com

Problem	Solution
The massage chair is connected to power but is not functioning.	Check to see if the power plug is inserted or if the power outlet is functioning properly.
The remote controller is responding, but the massage chair is not functioning.	The massage chair may have automatically shut down due to overheating protection devices. Please turn off the power and allow the chair to cool off for 30 to 50 minutes.
Both the remote controller and massage chair are not responding.	The massage chair automatically turns into "full stop" mode when a massage program is completed. Please press the power button again to turn of the chair.



KAHUNA CHAIR PRODUCT WARRANTY REGISTRATION
<https://www.kahunachair.com/services/>

PRODUCT SPECIFICATIONS

Description	Specifications
Product Name	Kahuna Massage Chair
Model No.	HM 5000
Rated Voltage	110-120V~
Rated Frequency	50/60Hz
Rated Power Consumption	120 W
Product Dimension (LxWxH)	57 x 26.5 x 47 inches
Weight (LBS)	Net Weight: 207lbs Gross Weight :236lbs



Product KAHUNA Massage Chair

Model HM 5000

Distributed by AJX Distribution INC

11125 Knott Ave, Suite D

Cypress, CA 90630

Tel 1-855-646-9500

Email INFO@KAHUNACHAIR.COM

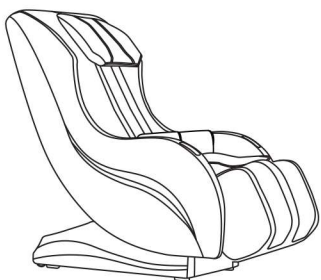

You must register warranty at www.kahunachair.com/services/

INSTRUCTION MANUAL
MODEL : HM 5000

Please read this user manual thoroughly
prior to operating the massage chair.
Store this booklet for future reference.