

INFINITY[®]

MASSAGE CHAIRS



User Manual

EVOLUTION 3D/4D

Your Chair

External Structure

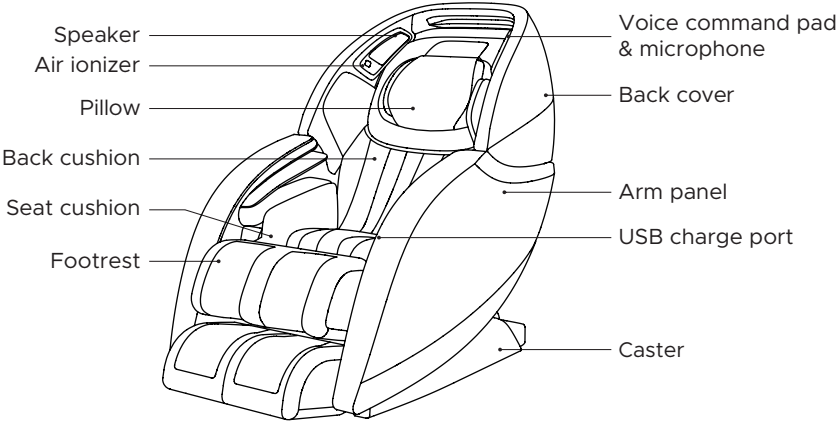

Remote Control

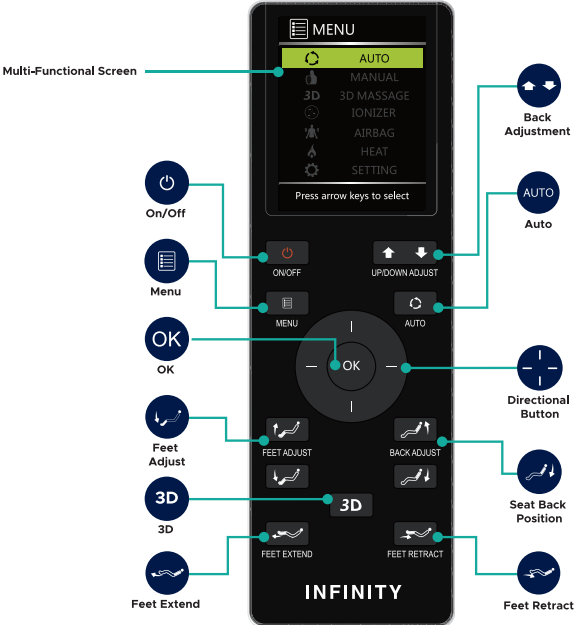

Welcome to

INFINITY[®]

THE ULTIMATE MESSAGE EXPERIENCE

Thank you and congratulations on purchasing an Infinity Massage Chair - you've made a great choice.

With over a decade of experience designing, building and servicing massage chairs, Infinity takes pride in every chair sold, including yours. We are here for you. The US-based Customer Care team can be reached at (603) 910-5000 or visit us online at www.infinitymassagechairs.com and find valuable self service resources under the SUPPORT tab, including electronic copies of all documents and video tutorials.

Inside this manual, you will find everything you need to setup and safely enjoy your chair. Please review the entire manual before assembling or using your chair. If you are assembling the chair yourself, please see the Assembly Guide next and reference the online assembly video.

For convenience, we've also created a Quick Start Guide. We suggest you keep it in the remote pocket as a tool to get to know all the features of your new chair.

Get ready to sit back, relax and enjoy the Ultimate Massage Experience.

Warranty Registration

Register your product at www.infinitymassagechairs.com/warranty to ensure it is in our system. This will simplify the warranty process should you ever need it.

Alternatively, **scan the QR code** to go directly to the URL above.



SCAN CODE

Assembly Video

Before assembling your chair, watch an assembly video at:
www.infinitymassagechairs.com/assembly-tutorials

Alternatively, **scan the QR code** to go directly to the URL above.



SCAN CODE



We know you can't wait to sit in your new Infinity Massage chair! Take a picture of you enjoying the ultimate massage experience and make sure to tag us on social media with the hashtag **#loveyinfinitychair**

Chair Features

Zero Wall Space-Saving Technology



See page 6

Body Scanning



See page 9

3D/4D Massage



See page 10

Memory Function



See page 10

Lumbar Heat



See page 13

Total Sole Reflexology Rollers



See page 13 & 19

USB Charging Port



See page 13

Calf Rollers & Oscillation



See page 13

Air Ionizer



See page 14

Bluetooth



See page 14

Intelligent Voice Control



See page 15

Apple/Android Application



See page 15

Manual Massage Customization



See page 18

Zero Gravity



See page 19

Table of Contents

Before Getting Started

Installation Site	6
Clearance Space for the Chair	6
Floor Protection	6
Move Methods	7
Connect to Power	7

Chair Setup

Getting Comfortable	8
Main Power Switch	8
Adjust Pillow	8
Reduce the Intensity of Your Massage - Manually	8
Body Scanning	9
Legrest Extend/Retract	9
Getting Out Of The Chair	9

Taking Control

Auto Programs	10
3D Massage	10
MyMassage Memory	10
Airbag Massage	12
Airbag Region	12
Airbag Intensity	12
Back Heat	13
Foot Rollers	13
USB Charging Port	13

Set Your Environment

Air Ionizer	14
Bluetooth Audio	14
Intelligent Voice Control	15
App Download & Installation	15

Settings

Timer	16
Language	16
Bluetooth	17
Voice	17
Remote Control Screen Idle	17

Build Your Own

Manual Programs	18
Back Massage Technique Mode	18
Massage Part (Back Region)	18
Back Node Width	19
Massage Speed	19
Foot Rollers	19
Zero Gravity	19

Staying Safe

20

Fixing Issues

Specifications	22
Trouble Shooting	22
Frequently Asked Questions	23

Before Getting Started

Installation Site

Clearance Space for the Chair

- 4" clearance for the recline of the backrest; 24" clearance for the extension of footrest and sliding forward of the chair.
- Keep it 3 feet away from the TV, radio or other audio & video appliance to avoid signal interference.

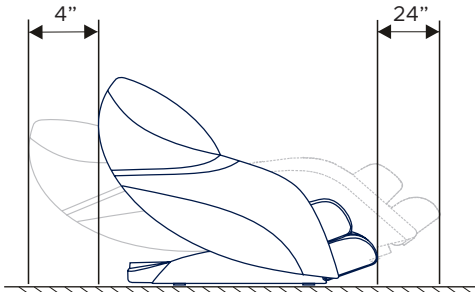

- Keep the distance between the power socket and power switch within 60" to avoid damage of power cord while massage chair sliding forward.
- Straighten the power cord while in use to avoid tangle or damage.
- When the massage chair sliding forwards or back, please check to make sure there is no children, pets or other obstacles around to avoid accident.

Floor Protection

We recommend to place a piece of thin carpet or soft mat underneath it to avoid damaging the floor.

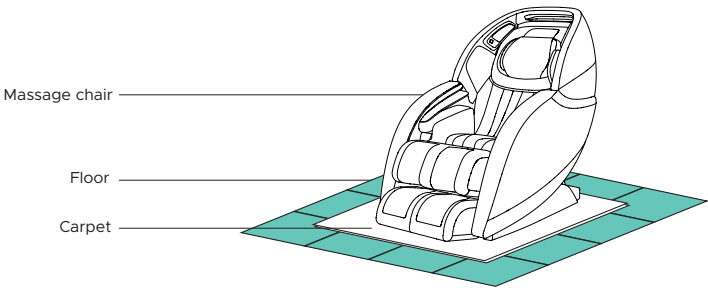

- Do not use the massage chair in high moisture environment such as near a swimming pool or bathroom to prevent electric shock accident.
- Please keep the massage chair away from heated surfaces to prevent fire hazard or damage to the product.

Move Methods

Apply pressure to the back of the massage chair from behind to pivot on the Castors. Have a second person up front to guide the Footrest until in the correct position. Maintain clearances as mentioned above. Gently lower into place. Do not pull on the side arms.

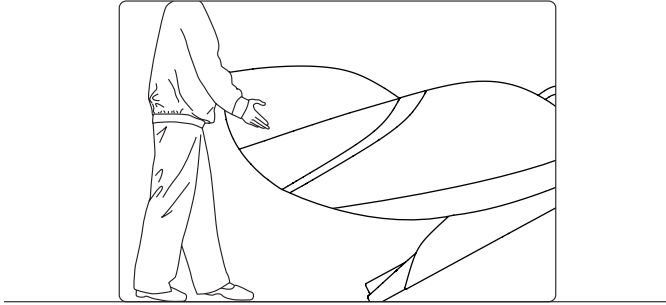

- Do not move the chair when there is user inside.
- To carry this product, do not lift by the footrest or armrest, hold the chassis and steady the backrest (have 4 or more people to carry the product).

Connect to Power

Plug into a 110V grounded outlet.

Grounding Instructions

This product must be grounded. If it should malfunction or breakdown, grounding provides a path of least resistance for electric current to reduce the risk of electric shock. This product is equipped with a cord having an equipment-grounding conductor and a grounding plug. The plug must be plugged into an appropriate outlet that is properly installed and grounded in accordance with all local codes and ordinances.

DANGER – Improper connection of the equipment-grounding conductor can result in a risk of electric shock. Check with a qualified electrician or serviceman if you are in doubt as to whether the product is properly grounded. Do not modify the plug provided with the product – if it will not fit the outlet, have a proper outlet installed by a qualified electrician.

This product is for use on a nominal 120-V circuit and has a grounding plug that looks like the plug illustrated. Make sure that the product is connected to an outlet having the same configuration as the plug. No adapter should be used with this product.

Earthing

This massage chair belongs to Level One electrical appliance, make sure to use three-core power supply socket and to guarantee the ground wire connected to the power supply socket has obtained good ground connection to avoid electric leakage, electric shock and some other negative effect during use.

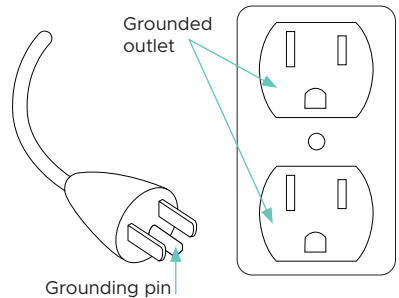

- Ensure there is no damage to the supply cord before switching on the massage chair.
- Ensure that the main power switch is turned off before connecting to power

Chair Setup

Getting Comfortable

Main Power Switch

To power up the chair, flip the main power switch located on the back of the base of the chair to **ON**.

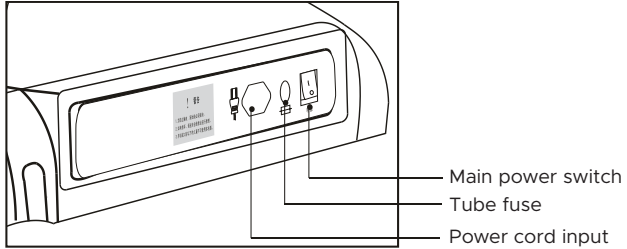

- Children should be supervised to ensure that they do not play with the chair or touch the power box.
- Always unplug the massage chair from the electrical outlet immediately after use.
- Unplug from outlet during thunder or lightening storms, and before putting on or taking off parts.
- Turn off the power switch and unplug the massage chair from the electrical outlet while not in use to avoid children powering on the massage chair accidentally.
- When not in use for a long period of time, we recommend that the chair be covered, the power cord be coiled and that the unit be placed in an environment free of dust and moisture.

Adjust Pillow

Take a seat in the chair and take note of where the neck pillow rests on your neck. Adjust the pillow so that it rests comfortably in the arch of your neck. Do this by removing it from the velcro, aligning it, and then reattaching to the velcro once it is in the desired position.

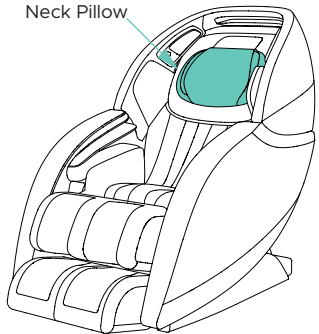

Reduce the Intensity of your Massage - Manually

To make the massage less intense, you can **add the back pad** to the seat back of your chair, or you can also **fold down the neck rest** to provide more cushioning between you and the massage mechanism in the seat back. To make the foot rollers less intense, insert the foot pads that came with your chair into the foot bed of the footrest.

Smart tip: To increase intensity in the neck and shoulder region, flip the pillow or the pillow and pillow pad up so you lay directly on the seat back pad.

Body Scanning

Select any auto program and press the **OK** button. The chair will automatically begin scanning your body, mapping your back, shoulders, and neck. During this process it is important to remain seated back into the chair without lifting your head.

The scan can be viewed on the remote control screen. If fine tuning is needed just after your body scan, wait for the **shoulder adjust prompt** to appear and then use the **Back Adjustment** buttons to move the massage rollers up or down for the perfect shoulder kneading position.

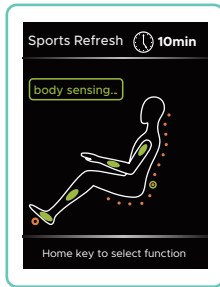

Body Scanning

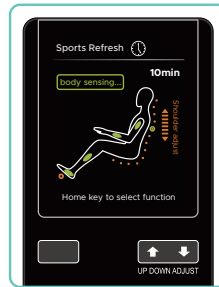

Shoulder Adjust Prompt

Legrest Extend/Retract

Your chair will automatically set the leg length, however, if you need to adjust, the legrest can be extended or retracted manually. To adjust the legrest, press the **feet extend** or **feet retract** button.

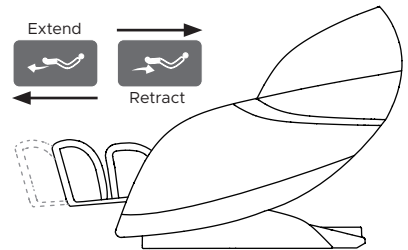

Getting out of the Chair

To easily exit the chair at any time, press the **ON/OFF** power button on the remote control to restore the chair to the upright position.

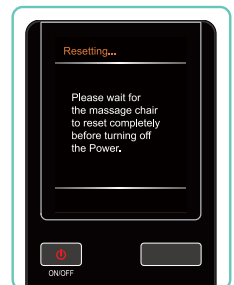

Taking Control

Auto Programs

When massage chair is operating, press the **AUTO** button on the remote control to enter Auto Program Menu. Choose from **Sports Refresh, Extension, Rest & Sleep, Working Relief, Neck & Shoulder, Waist & Spine, MyMassage 1, or MyMassage 2**. Press **OK** to enter the program you desire. Selected program will show on the home screen.

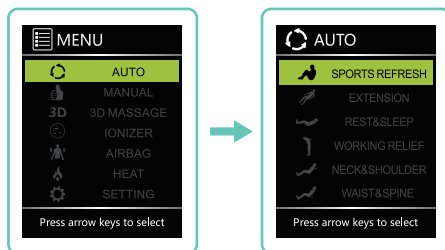

3D Massage

As well as the programs in the AUTO section, there are 3 additional 3D Massage programs. To access, select **3D MASSAGE** from Home display, navigate to **MODE** and then choose from **Deep shiatsu, Healthy Breath, or Message Extend**. Press **OK** to enter the program you desire. Selected program will show on the home screen.

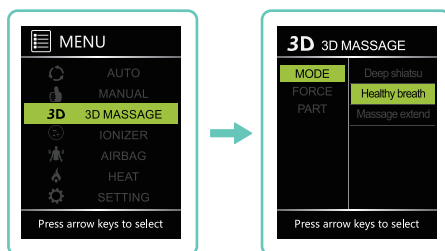

To adjust the intensity or region of your 3D Massage, press up or down button to navigate among: **FORCE** and **PART**.

MyMassage Memory

Your chair has the ability to save your favorite customized massage programs to memory. To do this, **create a manual massage program** (see page 18 for instructions) with all of your desired air, heat, speed, and intensity settings.

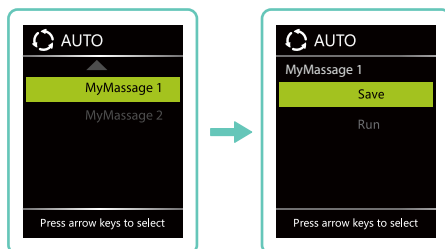

Storing a memory program:

After creating your custom massage in manual mode, select **AUTO** from the Home display and scroll to the bottom of the page. Here you will see **MyMassage 1** and **MyMassage 2**. Press **OK** button to select either 1 or 2 then select **“Save”**. If you save over the top of an existing memory program, the existing program will be erased and replaced by the most recent save.



Loading a memory program

Select **AUTO** from Home display and scroll to the bottom of the page. Select **MyMassage 1** or **MyMassage 2** and then select **“Run”**. The chair will now run the program you created.

Program	What for?	Description
Sports Refresh	Soothe muscles after sports activities and exercise.	Relaxes muscles and speeds up recovery time after intense exercise by promoting circulation.
Extension	This program is the best choice to relax tired muscles and increase physical vigor.	Inspired by Thai massage. The strong kneading and stretching functions effectively decompress the entire body.
Rest & Sleep	Try this program as you prepare your body to rest for the night.	Kneads the entire body with a gradual lightening of intensity massage to relieve tired muscles.
Working Relief	This is a great program for people who work at a desk or travel a lot.	Performs a strong massage to ease muscles and recuperate the body.
Neck & Shoulder	Soothing pain and tension in the neck and shoulders.	A sequence of neck, shoulder, and upper back massage techniques.
Waist & Spine	Helps to relax and recover the main back muscles along your spine.	Focuses on the lumbar vertebra with targeted massage to relieve tension in this area.
3D Massage 		
Deep Shiatsu	This program is recommended to relieve lower back pain.	Deep shiatsu on the back for 10 minutes.
Healthy Breath	Designed for morning or midday relaxing.	Rhythmic five-minute massage to aid with deep breathing.
Massage Extend	Reduce built up tension carried in the body from everyday stress.	Designed for morning or midday relaxing, this massage helps to boost the vitality of muscles.
MyMassage Memory 		
MyMassage 1	Saving custom built massage programs.	
MyMassage 2	Saving custom built massage programs.	

Taking Control

Airbag Massage

Select **AIRBAG** from Home display, press up or down button to navigate among: **PART** and **FORCE**. Select by pressing **OK**.

PART allows you to select which airbags to use. Select Full for all airbags. Otherwise pick and choose amongst the other Parts to turn them on or off. You may select more than one Part. To turn off all Airbags, select any lit parts and hit **OK** to turn off. When no Parts are lit, all airbags are off.

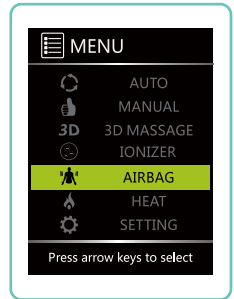

Airbag Region

Navigate to **PART**, press right button, then use the up or down button to select your desired airbag region: Full, Arm & Shoulder, Back and Waist, Leg & Foot, Buttock. Press **OK** button to select the airbag region.

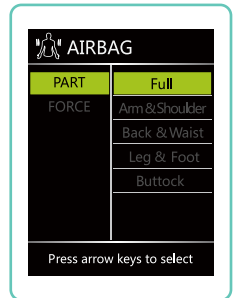

Airbag Intensity

Navigate to **FORCE**, press right button, then use the up or down button to select your desired intensity: 1 = light, 5 = firm, or Off. Press **OK** button to select the airbag intensity.

While the in-use screen is displayed during a massage program, press the **left** or **right directional button** to adjust the airbag intensity (this feature works in both Auto and Manual programs).

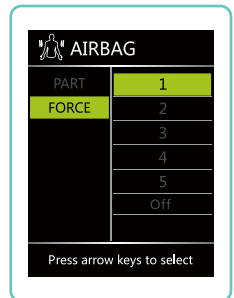

Smart tip: While the in-use screen is displayed during a massage program, press the **left** or **right directional button** to adjust the airbag intensity (this feature works in both Auto and Manual programs).

Back Heat

Select **HEAT** from Home display, press right button, then press up or down button to navigate to desired heat setting: On, or Off. Press **OK** button to select the heat setting.

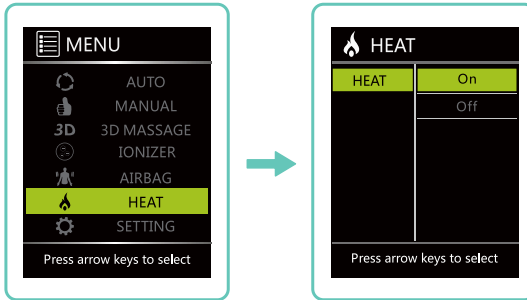

Foot Rollers

Select **MANUAL** from Home display, then press up or down button to navigate to **ROLLER**. Press right button, then use the up and down buttons to select your desired foot roller speed: 1 = slow, 2, 3 = fast, or Off (deactivate foot roller). Press **OK** button to select the foot roller setting.

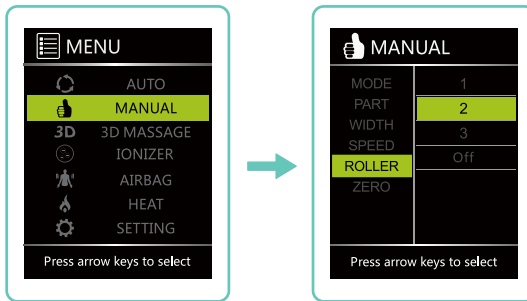

USB Charging Port

Your massage chair includes a USB-A port to charge your phone or tablet while using the chair. This feature is especially helpful when using the app to control the chair.

The port is located on the **left hip side of the chair behind the thigh airbag**. To access, locate the thigh airbag and pull it back, away from the chair to reveal the USB port.

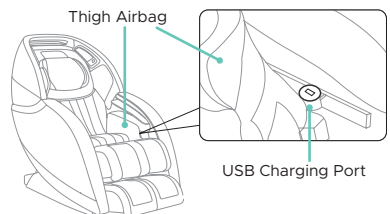

Set your Environment

Air Ionizer

Select **AIR IONIZER** from Home display, press right button, then press up or down button to select your desired Air Ionizer setting: On, or Off. Press **OK** button to select the setting.

Note: the Air Ionizer is only active on the right side of the chair and not the left. This is how this feature functions.

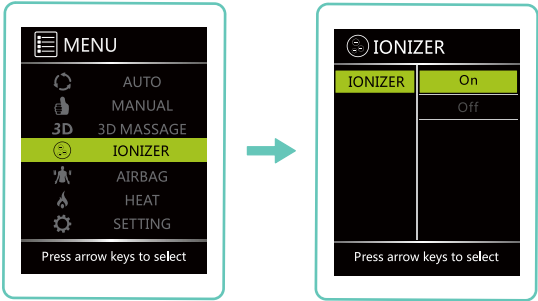

Bluetooth Audio

Your massage chair includes Bluetooth compatibility so you can play and enjoy your favorite music. To turn on your chair's Bluetooth, select **SETTING** from Home display, then press up or down button to navigate to **BLUETOOTH**. Press right button, then press up or down button to select your desired Bluetooth setting: On or Off. Press **OK** to select setting.

Open Bluetooth from audio device and pair with **Evolution** to play music.

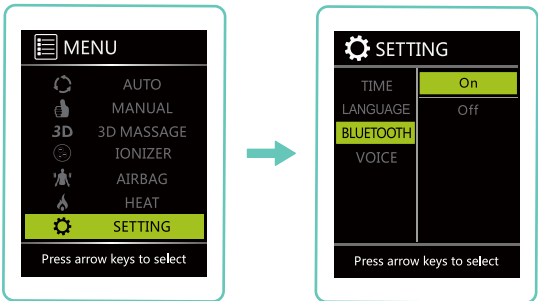

Smart tip: Have your command ready before activating voice control. After 5 seconds the voice command function will turn off automatically and must be awakened again.

Intelligent Voice Control

Your chair comes with built in intelligent voice control. This feature allows you to control your chair and massage experience completely hands-free by using one of the many voice commands.

To activate the intelligent voice control function, simply say '**Switch to Voice Mode**'. You may now give your chair any of the commands to the right **within 5 seconds**. Alternatively, you can touch the voice command pad on the left speaker to activate, and then speak your command within 5 seconds. Make sure to speak clearly and slowly. After 5 seconds the Intelligent Voice Command function will turn off automatically and must be awakened again.

Turn Off Listening

You can turn off intelligent voice control listening by using the remote control. Select **SETTING** from Home display, press up or down button to navigate to **VOICE**, press right button, then press up or down button to select **Off**. Press **OK** button to select the setting. Intelligent voice control will now no longer activate until turned back on.

Commands

Power On
Switch Off
Activate Massage
Sports Refresh
Extension
Rest & Sleep
Working Relief
Neck & Shoulder
Waist & Spine
Airbag Massage
Deep Shiatsu
Healthy Breath
Massage Extend
Zero Gravity
Start Heat
Heat Off

App Download & Installation

Android System Software (Android System V2.2 or later)

- Open the Google play store. In the search bar, search for '**Infinity Massage Chair Evolution**'. Click on the Evolution app tile.
- Click "Install" to download and install the Evolution **APK**, then press Settings button on your computer or Android device > press Wireless and Web Setting > Bluetooth > Scan Bluetooth device > Evolution, then pair.
- Start the Evolution APK, press Settings menu > Bluetooth > and pair with the Evolution to link the APK

Apple iOS: (iPhone or iPad devices)

- Open the App Store. In the search bar, search for '**Evolution by Infinity**' to find the app. Click "Get" at the top right corner to download and install the software.
- In your device settings, open Bluetooth and connect it to the massage chair.
- *Please note: Only Apple equipment compatible with Bluetooth 4.0 can connect to the chair's Bluetooth.*

Settings

Setting

Select **SETTING** from Home display, then use the up or down button to toggle between **Time, Language, Bluetooth, or Voice.**

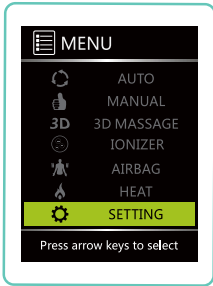

Timer

Navigate to **TIME**, press right button, then use the up or down button to select your desired timer: 10mins, 20mins, or 30 mins. Press **OK** button to select timer.

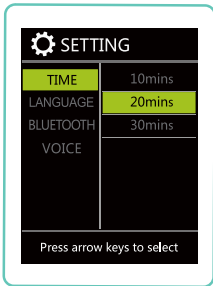

Language

Navigate to **LANGUAGE**, press right button, then use the up or down button to select your desired language: Chinese or English. Press **OK** button to select language.

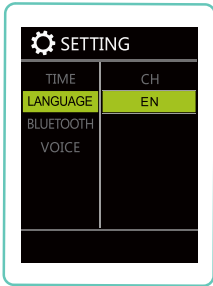

Smart tip: All settings listed below will be **memorized** when you turn off the massage chair.

Bluetooth

To connect your Android or Apple device, press **SETTING** from Home display, then press up or down button to navigate to **BLUETOOTH**. Press right button, then press up or down button to select your desired Bluetooth setting: On or Off. Press **OK** to select Bluetooth setting.

In order to use the chair app or to play music from your Bluetooth enabled audio device, Bluetooth must first be turned on in settings.

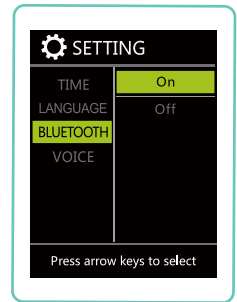

Voice

Navigate to **VOICE**, press right button, then press up or down button to select your desired voice control setting: On, or Off. Press **OK** button to select the setting.

To activate voice control function without going into settings, touch the button on the left speaker or say **“Switch to voice mode”**.

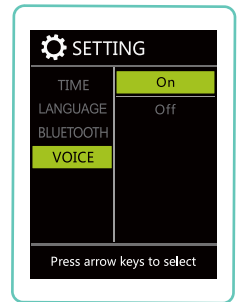

Remote Control In-Use Screen

Whilst running an Auto Program or Manual mode, the remote control screen will return to the in-use screen (as shown below) **after 10 seconds of being idle**.

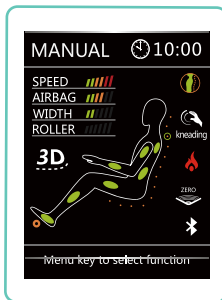

Manual in-use screen

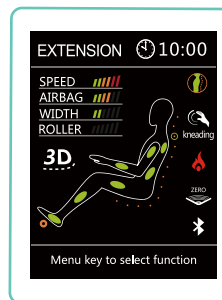

Auto Program in-use screen



- Please do not spill water or other liquids on the controller in order to avoid key malfunctions and error codes.
- Please do not place heavy objects on the controller or power cord.

Build your own

Manual Programs

In Manual mode you can operate components of your massage chair individually or combine them to create unique massage scenarios.

If you create a manual massage you love, you can save it to memory and go back to it whenever you want. See **'MyMassage Memory'** on page 10 for instructions on how to do this.

Press **MANUAL** from Home display, press up or down button to navigate among: **MODE, PART, WIDTH, SPEED, ROLLER, and ZEROG.**

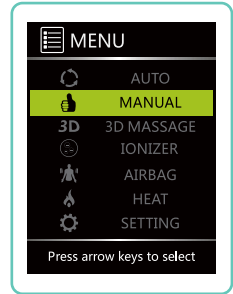

Back Massage Technique Mode

Navigate to **MODE**, press right button, then use the up or down button to select your desired mode: Kneading, Tapping, Knocking, Shiatsu, Sync. Press **OK** button to select mode.

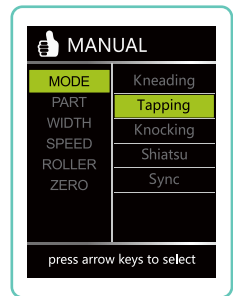

Massage Part (Back Region)

Navigate to **PART**, press right button, then use the up or down button to select your desired region: Whole, Partial, and Point massage. Press **OK** button to select region.

Whole travels the entire length of the track.

Partial travels a short distance and reverses direction for focused relief.

Point stops on the track for targeted relief.

Partial and Point location can be fine tuned using the **Back Adjustment** arrow up or arrow down buttons

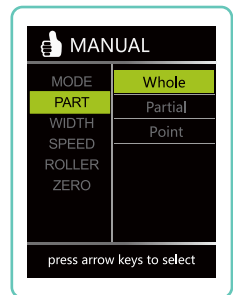

Smart tip: Message **Width** can't be adjusted when in Kneading, or Sync mode techniques. Message **Speed** can't be adjusted when in Shiatsu.

Back Node Width

Navigate to **WIDTH**, press right button, then use the up or down button to select your desired width: Wide, Medium, and Narrow roller width. Press **OK** button to select mode. (Message Width can't be adjusted when in Kneading, or Sync Manual modes).

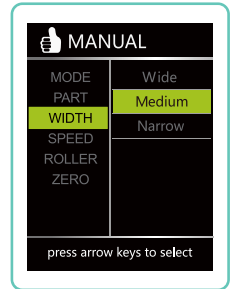

Massage Speed

Navigate to **SPEED**, press right button, then use the up or down button to select your desired speed: 1 = slow, 6 = fast. Press **OK** button to select the speed. (Message Speed can't be adjusted when in Shiatsu).

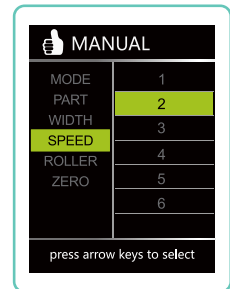

Foot Rollers

Navigate to **ROLLER**. Press right button, then use the up and down buttons to select your desired foot roller speed: 1 = slow, 2, 3 = fast, or OFF (deactivate foot roller). Press **OK** button to select the speed level you desire.

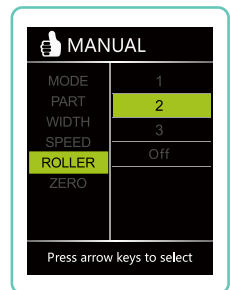

Zero Gravity

Zero Gravity mode will recline the back and elevate the feet to reduce the gravitational force on your spine. Navigate to **ZERO**, press right button, then use the up or down button to select your desired Zero Gravity setting: On or Off. Press **OK** button to select the setting.

While the in-use screen is displayed during a massage program, press the **OK** button to switch to Zero Gravity mode (this feature works in both Auto and Manual programs).

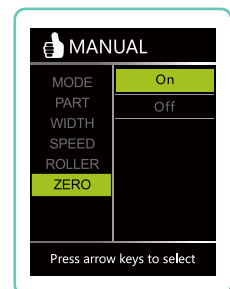

Staying Safe

Safety Precautions

Precautions listed below will help to ensure proper use of this appliance.

Read all instructions before using this appliance.

For household use only.

SAVE THESE INSTRUCTIONS.

Not Suitable For Below Persons

We recommend those with any of the following conditions consult your physician before using.



- Those who are using electronic medical instruments embedded in the body, such as a cardiac pacemaker.
- Those undergoing treatment, especially those who are not feeling well.
- Those with malignant tumors or malignant abscesses. (Need to be supervised)
- Women who are pregnant.
- Those with osteoporosis or a fractured spine.
- Those with skin diseases or those with skin injuries.
- Those with a high fever.
- Close supervision is necessary when this product is used by, on, or near children, invalids, or disabled persons.
- The appliance has a heated surface. Persons insensitive to heat must be careful when using the appliance.
- This appliance can be used by children aged 8 years and above and persons with reduced physical, sensory, or mental capabilities, or lack of experience and knowledge, if they have been given supervision or instruction concerning the use of the appliance in a safe way and understand the hazards involved.
- Children shall not play with the appliance.
- Cleaning and user maintenance shall not be made by children without supervision.

Control Buttons Precautions



- Do not operate the control buttons with wet hands.
- Do not spill water or other liquids onto the control buttons to avoid fault.
- Do not lay heavy objects on the controller.

Best Circumstances



- Do not operate under blanket or pillow. Excessive heating can occur and cause fire, electric shock, or injury to persons.
- Do not use this appliance when ambient temperature is over 40 C.
- Women who are pregnant should not use this chair.
- Do not use this appliance in humid or dusty environment, or when any part of the body is in contact with plumbing or any similar ground.
- Never operate the appliance with the air openings blocked. Keep the air openings free of lint, hair, and the like.
- Do not use outdoors.
- Do not operate where aerosol (spray) products are being used or where oxygen is being administered.
- Please place the product on a flat level floor.
- Do not store near heat or open flame.
- Connect this unit to a properly grounded outlet only. See Grounding Instructions.
- Do not use massager in close proximity to loose clothing or jewelry.
- Keep long hair away from massager while in use.

Cautions Regarding the Adapters and Cord



CAUTION

- Always unplug this appliance from the electrical outlet immediately after using and before cleaning.
- An appliance should never be left unattended when plugged in. Unplug from outlet when not in use.
- Unplug from outlet during thunder or lightning storms, and before putting on or taking off parts.
- Check that the power voltage stated on the rating label corresponds to your local electricity supply.
- Do not use a damp hand to unplug the cord to avoid electric shock.
- Do not drag the cord, reach to the front plastic end to unplug it.
- Do not squeeze, over bend, pull hard, or twist the cord.
- Keep the cord away from heated surfaces.
- Do not carry this appliance by supply cord or use cord as a handle.
- Never operate this appliance if it has a damaged cord or plug, if it is not working properly, if it has been dropped or damaged, or dropped into water. Return the appliance to a service center for examination and repair.
- To disconnect, turn all controls to the off position, then remove plug from outlet
- The appliance is only to be used with the power supply unit provided with the appliance.
- It must only be supplied at safety extra low voltage corresponding to the marking on the appliance.
- If the supply cord is damaged, it must be replaced by the manufacturer or its service agent or a similarly qualified person in order to avoid a hazard.

Best Practices for Safe Use



CAUTION

- Only for users who weigh below 300 lbs.
- Use this product only for its intended use as described in this manual. Do not use attachments not recommended by the manufacturer.
- Appliance should only be used by one person, do not use by two or more persons at the same time to avoid damage to the product.
- Do not use the product right after a meal, it may cause discomfort.
- Remove personal accessories from arms and empty pockets while using the massage services.
- Check the upholstery under the cushions and other spots, if any damages are present, do not use it and refer to a qualified service professional for servicing.
- If you feel any abnormal discomfort during the operation of this product, turn off the power immediately and do not use the product.
- Use of the appliance for 20 minutes each time is highly recommended.
- Make sure there are no obstacles behind the chair and there is enough clearance before adjusting the backrest or legrest angle.
- Make sure there is no other excessive load pressed on the backrest or legrest besides the user.
- Make sure there are no children, pets or other objects under the backrest or legrest.
- Please be seated properly while using the product.
- Do not drag or push the chair or roll on its caster on wood floor or carpet to avoid damage



- Do not stand on or stack heavy objects on the footrest.
- Do not fall asleep while the product is operating.
- Avoid using the product under the influence of alcohol.
- Never drop or insert any object into any openings.
- If there is any smoke or unusual smell while using, stop using immediately, and unplug the power cord.



- Do not disassemble this product yourself to avoid failure.
- Do not dismantle, fix or modify the product yourself. Please contact authorized dealer or service agent.

Fixing Issues

Specifications

Model	Evolution 3D/4D
Dimension of Main Body (in)	66 x 35 x 48 (L x W X H)
Necessary Clearance to Wall (in)	4"
Net Weight (lbs)	328
Shipping Weight (lbs)	404
Max. User Weight (lbs)	300
Voltage	110-120V
Fuse	1.4 AMP
Power Consumption	150W
Safety Standards	Type 1

Trouble Shooting

No.	Symptoms	Possible Causes	Possible Solution
1	Noise is heard while in use	These noises are normal and arise from friction between the massage rollers and the faux leather cover	No need to take any measures
2	Massage Chair does not start	<ul style="list-style-type: none"> - The power cord is not secured into the socket - Not switched ON - The fuse is blown 	<ul style="list-style-type: none"> - Insert the power plug properly into the power socket - Turn on the switch found on chair side. Then push power button on remote - Replace only with a fuse of same type and rating
3	No music comes from the speaker	The volume is turned to the lowest setting	Adjust the speaker volume from the mobile device. Make sure Bluetooth setting on chair and phone are both ON
4	Backrest or footrest can not raise or recline	Excessive load has been pressed on the backrest or legrest	Reduce the load and try again
5	Airbag malfunction	The air hose is blocked	Straight the air hose and clearout the blockage

If problem remains, please contact Infinity for maintenance.

Tip: Do not attempt to repair this product yourself, our company shall not be liable for the injury or damage caused by any servicing without authorizations. Thank you for your cooperation

Frequently Asked Questions

Q: I find the chair is too intense to be comfortable. What can I do?

A: Your body needs to become acclimated to therapeutic massage. To be effective, the massage techniques must compress the tissue in your body. We recommend the following steps to help get started. Then over time as your body acclimates you can increase the intensity by reducing the layers between you and the chair.

1. Use body the Pillow and Pillow pad to reduce upper body intensity.
2. Use the back pad that came with your chair to reduce back intensity.
3. Use the foot bed pads that came with your chair.
4. Go into Airbag on the main menu, scroll down to FORCE, select air intensity setting 1 - If a specific airbag is too intense, scroll down to PART, turn off Full and turn on only the airbags you want.
5. Go into Manual, select Rollers, and turn the foot rollers off.
6. Adjust the recline on the remote. More upright will be less intense. Zero Gravity will be more intense.

Q: I'm not a foot massage person, what should I do?

A: Turn off foot rollers, navigate to Manual on the home display, arrow down and select Rollers, then switch to off. You may also want to turn off the Foot/Calf airbags or reduce the air intensity to level 1. Finally make sure the foot pads are inserted into the foot beds on the foot rest.

Q: My chair is not performing as expected. What should I do?

A: Your Infinity massage chair is an amazing combination of programming and robotics. On occasion the chair just may need to be rebooted. To do this power down the chair and unplug from the wall for 5 minutes then plug back in and power back up to see if it self-healed. If you are still having an issue, give Infinity a call at 603-910-5000.

Q: I can never seem to get in my Infinity Massage chair, someone is always in it.

A: We know. It happens. Tell your friends to get their own Infinity Chair.

For more information and access to further questions, and resources, visit our website at www.infinitymassagechairs.com

INFINITY®

72 Stard Road, Seabrook, NH 03874
603-910-5000

www.infinitymassagechairs.com

Version 2.2