



**3** YEAR  
WARRANTY



Scan the QR code using a smart-phone device,  
for product warranty registration online.



**MISSION** 770



# Important Safety Information

Before installing this product read all these instructions!



This symbol indicates that there are important operating and maintenance instructions in the literature accompanying this unit.

Read these instructions. Keep these instructions. Heed all warnings. Follow all instructions.

Before making any connections, switch all the units in your system off at the mains.

Set the volume control at minimum when you switch on your system or change sources, and turn the level up gradually.

DO NOT use your amplifier at full volume.

Ensure that all loudspeakers in the system are correctly wired.

DO NOT subject your loudspeakers to excessive cold, heat, humidity or sunlight.

Loudspeakers should not be placed directly facing other hi-fi units, or share the same shelf or cabinet.

DO NOT place heavy objects on top of loudspeakers.

Some manufacturers forbid the placing of objects on top of their TV sets. Check your TV handbook before installing the speaker directly on your TV set. Consult your TV dealer if you are in any doubt.

DO NOT connect speaker terminals to the mains supply.

DO NOT dismantle the loudspeaker. There are no user serviceable parts inside it and you will void the warranty by doing so.

Refer all servicing to qualified service personnel. Servicing is required when the apparatus has been damaged in any way, the apparatus has been exposed to rain or moisture, does not operate normally, or has been dropped.

Caution: Changes or modifications not expressly approved by the manufacturer could void the user's authority to operate this device.

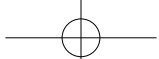

## CONTENTS

- 04 Music Leads,  
Technology Follows
- 05 Designer's Notes
- 14 Loudspeaker Installation
- 17 Warranty Coverage
- 21 Technical Data

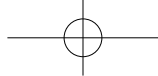

# Music Leads, Technology Follows

Mission has built a world-class reputation for advanced audio design since the company's formation in Huntingdon, Cambridgeshire in 1977, with an engineering-led approach to product development that has resulted in some of the most popular and iconic loudspeakers, ever devised.

Three things have always characterised Mission speakers. First, the cabinets and drive units use innovative materials and sport a distinctive, modern appearance. Second, the sound they produce is fast, detailed and engaging. Third, they deliver excellent sonic and material value for money.

Today, Mission continues to stretch the boundaries of what can be achieved at specific price points, pioneering technologies to create fresh, new designs. Mission's team of engineering experts is headed by award-winning audio designer Peter Comeau whose history with the Mission brand stems from when he joined Mission as Director of Acoustic Design in 1999. The brand benefits from the unrivalled manufacturing facilities and global reach of parent company IAG, with the majority of component parts of every loudspeaker now made in-house.

Yet the company's roots remain firmly entrenched in Huntingdon, where much of Mission's design, servicing and technical support work is still carried out. This, coupled with a design team brimming with British and European talent, ensures Mission speakers remain as impressive today as they were when the company first established itself at the forefront of the burgeoning British audio scene more than 40 years ago.



mission

## The Origins

Legend has it that Farad Azima, Founder and CEO of Mission, was so taken with the design of the Sendor BC1 that he wanted to improve upon it. Thus started the legendary Mission 770, a two-way vented loudspeaker in the classic mode of the late '70s that was to shake up the hi-fi world.

On the face of it, Mission 770 was nothing special. But, then, it's often what's under the surface that surprises you. At its heart was a polypropylene cone, 8-inch bass unit that had started out life as a Chartwell design and transmogrified into a unit from SEAS of Norway by the time I got to hear a prototype. The treble unit also came from SEAS and was a plastic 25mm dome. This pairing was then placed on a white front baffle with a simple cardboard tube bass reflex port at the bottom, surrounded by a chipboard cabinet heavily damped with bitumastic pads.



Above: The first legendary Mission 770, a two-way vented loudspeaker in the classic mode of the late '70s that was to shake up the hi-fi world.

# MISSION

## ELECTRONICS

## Designer's Notes

*The mid '70s saw the expansion of subjective reviewing, as opposed to the almost perfunctory paragraph of 'listening notes' added to the end of extensive measurement and technical description reviews that had gone before, and Farad made the most of his editorial press connections.*

*I was a contributor to Hi-Fi Answers at the time and so witnessed hearing some of the prototypes that Farad presented at Paul Benson's (the editor) flat. Among other reviews, it was Paul's revelatory review in HFA that described the magic of the musicality of the 770 which was like a breath of fresh air amongst loudspeakers of the time.*



*Above: Around 1978, Mission's legendary 770, the originator of the famous 700 series, was personally designed by Farad Azima.*



*Above: Instantly recognisable in style and performance, the 700 series, and 770 in particular, are still hallmark Mission designs.*

## Designer's Notes

### Classically Modern

*The 770 soon became highly popular. It quickly turned into Mission's best-selling speaker and gravitated naturally into Mk2 and Mk3 revisions with improvements to sensitivity and power handling. After that, the design eventually migrated to Freedom and other variations, but none of them created the sales impact or notoriety that the original 770 received.*

*For the 'new' Mission 770, I was eager to revisit the original Mk1 design and hear, again, the highly musical performance that I had witnessed back in 1978. The key to the 770's performance was, indeed, that combination of polypropylene cone and resonance controlled cabinet and, so, this became the emphasis for the design of the new model.*

*Accordingly, we developed a new polypropylene driver, mimicking the extended response and low colouration of the original, while upgrading the motor system to take account of modern power handling and dynamic requirements.*



# Designer's Notes

## Drivers Anew

Naturally, like the original, the driver is built on to an 8-inch (200mm) die-cast chassis with large rear 'windows' to reduce early reflections back through the cone. Special care has been taken to marry a low density nitrile surround to the cone to match its impedance and reduce reflections from the cone edge.

This new polypropylene cone has been treated with mineral filling to make it stiffer than the original, yielding a very tight and fast bass that enables you to hear exactly how bass instruments are being played. This is balanced by tuning the cabinet and reflex port to a very low frequency, avoiding the 'one-note bass' that is typical of a lot of bass-reflex systems. In addition, the port is strongly flared at both inlet and outlet to smooth airflow and eradicate distortion. Bass extends powerfully and cleanly to below 30Hz in room, which is remarkable for this size of speaker.

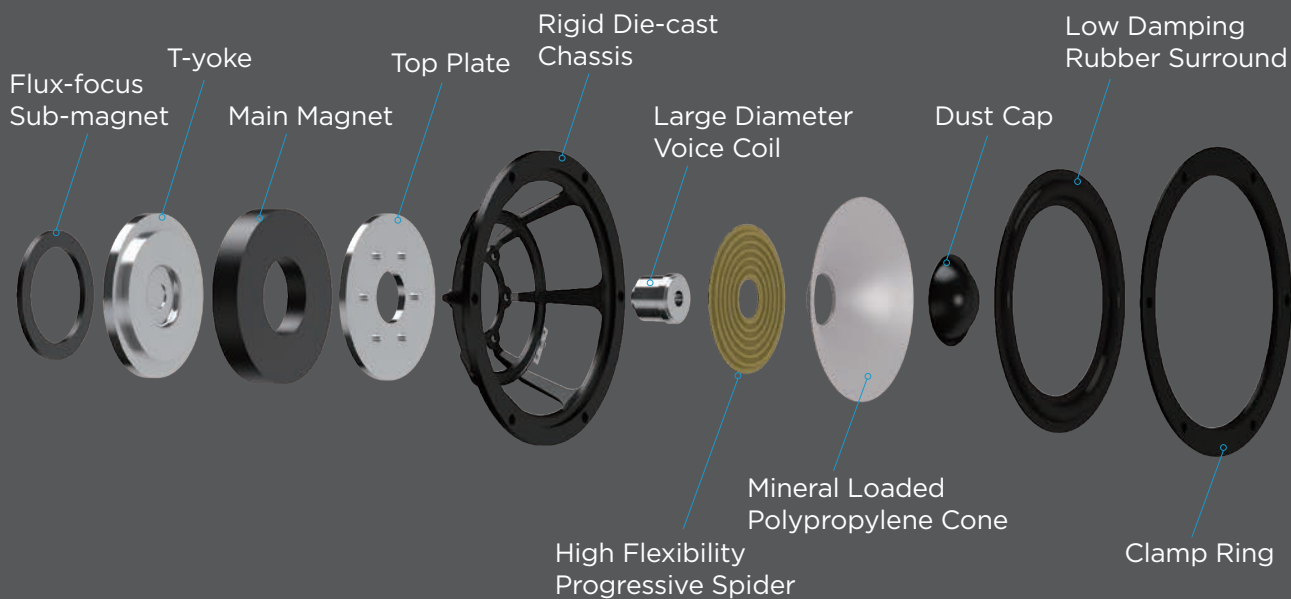

Above: Exploded technical diagram for the new Mission 770 bass unit.



## Drivers Anew

*For the new 770, we have chosen a lightweight, damped microfibre dome with a super smooth response, backed by a damped rear chamber that pushes the fundamental resonance well below the crossover region. The quality of this 28mm treble dome matches and marries to the polypropylene bass/midrange to ensure evenness of character throughout the range of the whole speaker.*

*The original 770 crossover used a single coil to both balance and equalise the bass to midrange response as well as cross over to the treble unit, the latter driven by a resistor, capacitor and coil combination. This was always going to be a compromise solution as it is not easy to use just a few components to perform both functions.*

*Today's advanced software crossover mapping and measuring techniques allow us to accurately equalise the bass/midrange balance and adjust the crossover to the treble unit by mapping the acoustic crossover slopes accurately. The simplicity and elegance of the original 770 crossover has been maintained, with additional elements added only to optimise the crossover performance while retaining the musical character.*

*The best acoustic performance, featuring a seamless transition between the bass and treble units while retaining all the thrilling musical detail and emotion of the performance, has been realised through hundreds of hours of listening sessions, using a wide variety of music.*

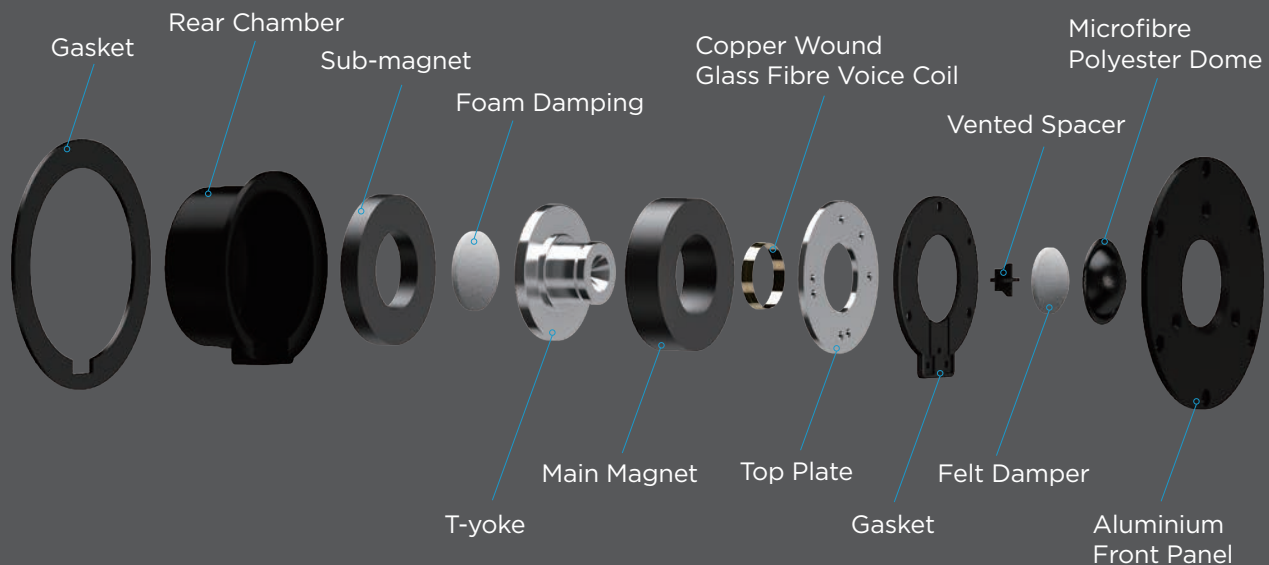

*Above: Exploded technical diagram for the new Mission 770 treble unit.*

## Designer's Notes

### A Genuine Classic

*Drivers and crossover are housed in a real-wood veneered cabinet with white laminated front baffle that echoes the style that made 770 a stand-out product in the '70s hi-fi market. Beneath the rich rosy-tinged walnut or black veneers lies a further technological achievement. While the original 770 reduced midrange colouration through the use of the BBC influenced technique of a thin-wall cabinet damped by mass loading with bitumen pads, the new 770 features a twin wall sandwich of high-density MDF and particleboard bonded by a layer of high damping glue. This results in a cabinet with panel resonance well below audibility, allowing the drive units to do their job unsullied by cabinet colouration at all frequencies.*

*Internal bracing adds strength to the front baffle to create a mechanical support that aids the dynamic performance of the bass unit and reveals the micro-dynamics of the musical performance. Finally, the internal absorption layer of acoustic foam and fibre has been specially chosen and adjusted to absorb reflections inside the cabinet without overdamping the bass quality.*

*To repeat the 770's brochure claims of 'staggering bass definition and response; lack of colouration; uncanny imaging; information retrieval; transient attack; depth and perspective; accuracy and linearity; speed and dynamic range' is only to hint at the real performance of the 770. Instead, we prefer to focus on the 770's uncanny ability to reveal the true depth, emotion and drama of whatever music you care to feed to it.*

*We are sure you will find that a classic design has been reborn.*



PETER COMEAU  
Director of Acoustic Design  
IAG Group Ltd

# Designer's Notes

## Mission 770 Cabinet

- Real-wood veneered cabinet with white laminated front baffle.
- Features a twin wall sandwich of high density MDF and particle board bonded by a layer of high damping glue.

## Mission 770 Air Profiled Port

- The low frequency energy is vented to the custom engineered, flared port at the speaker's front. The port is specially profiled to allow smoother airflow.
- The result is natural bass extension to below 30Hz, in room.

## Mission 770 Treble

- Light-weight damped microfibre dome with a super smooth response.
- High flux ferrite magnet engineered for detailed HF extension.

## Mission 770 Bass

- Totally new, and improved, polypropylene driver with design cues and pedigree taken from the original **770** design.
- Upgraded motor system, taking into account of modern power handling and dynamic requirements.

## Mission 770 Stand

- The custom designed, British design and built, **770** Stand ensures the optimum presentation both visually and acoustically.

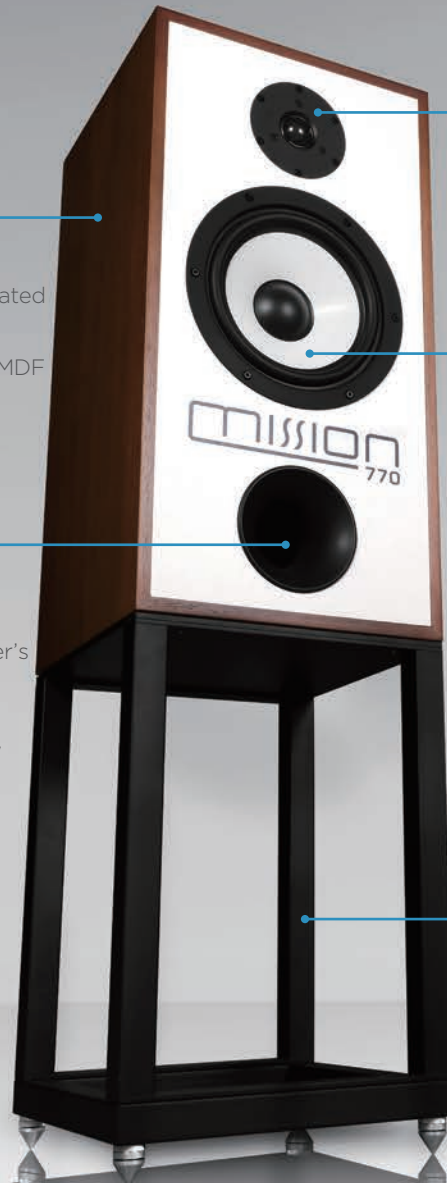

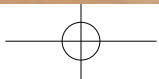
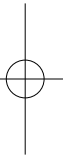
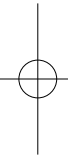
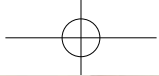

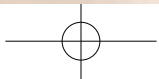
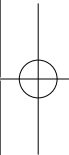
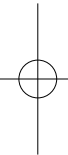
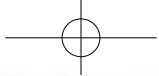

# Loudspeaker Installation

## Unpacking Your Loudspeakers

- Please read this manual as soon as you have opened the carton.
- Lift the loudspeaker carefully out of the packing. Do NOT try to lift the loudspeaker using the cloth bag.
- Unpack any accessories carefully.
- If there is any sign of damage or if the contents are incomplete, report this to your dealer as soon as possible.
- Retain the packing for future safe transport of the product. Dispose of the packing with respect to any recycling provisions in your area.

## Positioning Stereo Loudspeakers

- Place the loudspeakers on rigid stands. We strongly recommend the Mission 770 stands which have been purposely designed to achieve the best performance from your speakers.
- If you are sitting within 2 metres of the speakers, the distance between the speakers should be similar to the distance between you and the speakers.
- Otherwise site the speakers between 2 to 2.5 metres apart, clear of room corners. The quality and quantity of bass can be adjusted by moving the speakers closer to, or farther from, the wall behind the speakers.
- If the loudspeakers are placed too far from the walls, the bass may be too light and lacking warmth. If the loudspeakers are placed too close to the walls the bass will increase but may be boomy and indistinct. If the loudspeakers are placed further apart, the inward angle ("toe in") may be increased by up to 30%. As personal taste and room acoustics play a large role, experiment with different configurations and play a wide range of programme material before finalising the position of your speakers.
- The optimum listening position is in an area between the speakers broadly known as the "sweet spot". The more extreme the angle of toe-in the narrower the sweet spot. Mission loudspeakers are designed to cover a wide sonic perspective so there should be no need for extreme settings. A mild angle inwards will cover a wide range of seating positions.
- The grilles are provided to protect the loudspeaker drive units from accidental damage. For critical listening, you may remove the grilles.

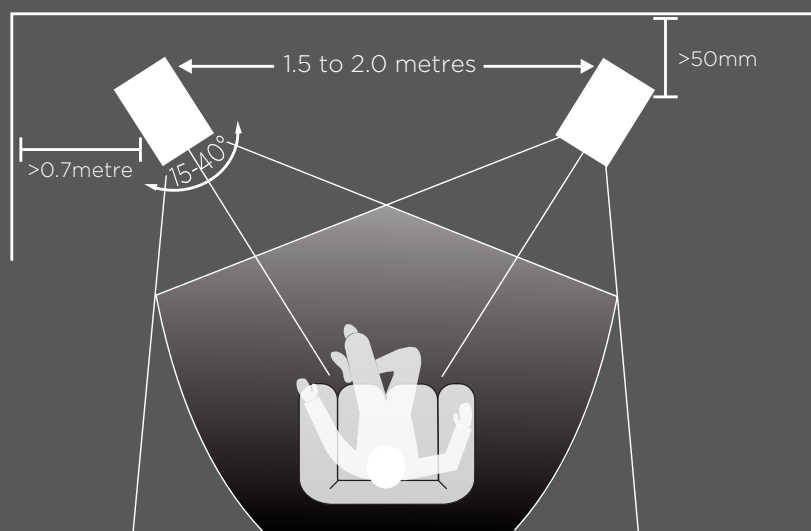

# Loudspeaker Installation

## Setting Up a Home Theatre System

- Front and Effects Channels: The front loudspeakers are placed on either side of the television screen, 2 to 3 metres apart. The speakers should be angled slightly so they are aimed towards listeners. We recommend placing the rear effects speakers in a high position, behind the listener's head. If the rear or side walls are a long way from the listening seat, consider stand mounting the loudspeakers. If the centre loudspeaker is very high or low, angle it towards the listener's ear level.
- The front faces of the centre and surround loudspeakers should also be in line as far as possible.
- Subwoofer: As the ear is unable to detect the direction from which deep bass originates, you have freedom to position the unit. Varying the distance from the wall alters the bass. Placing the subwoofer across a corner boosts the bass but may impair clarity. The performance of a home theatre system can be enhanced by using two subwoofers.

## 6.1 and 7.1 System Placement

- Dolby Labs, DTS and THX offer 6.1 and 7.1 format. Although the precise configuration of these systems will depend on the capabilities of your processor and you should be guided by those instructions, we would make some observation.
- For 6.1 and 7.1 formats the listening seat should not be too close to the rear wall.
- Optimising the time delay so that information from all speakers arrives at the listening seat coherently is critical if the benefits of these systems are to be fully realised.
- Dolby Labs Recommended Placement for Multichannel Home Theater Systems.

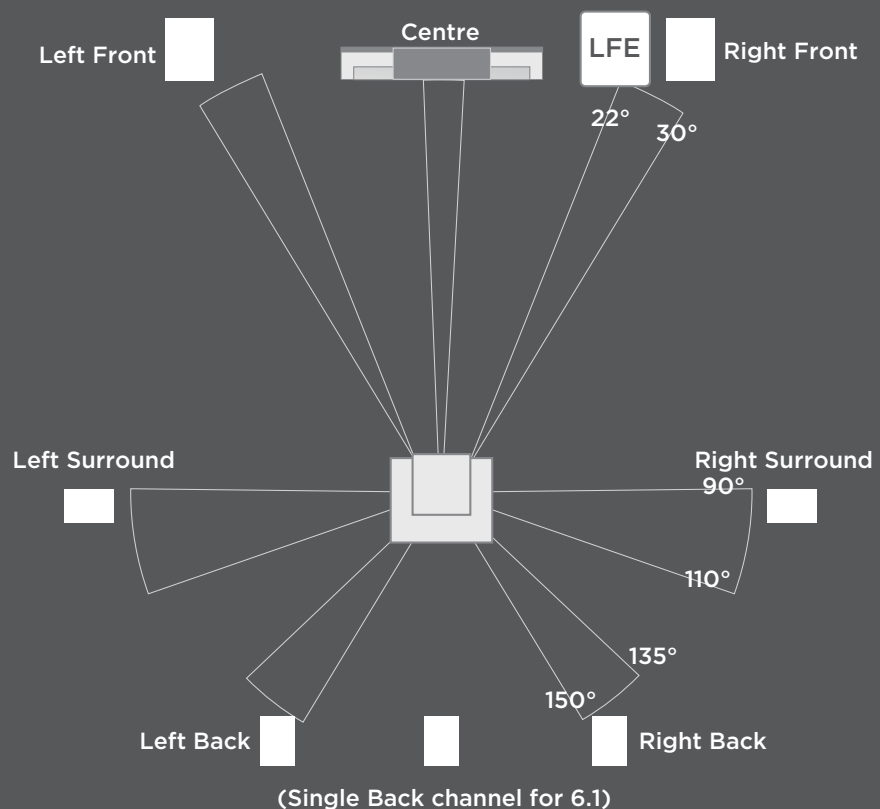

# Loudspeaker Installation

## Standard Connection

- Choose a suitable length of twin core speaker cable for each channel and prepare the ends. Unscrew each terminal a few turns. Connect the red, positive (+) terminal of the Left loudspeaker to the corresponding red, positive (+) amplifier terminal.
- Connect the black, negative (-) terminals similarly. Tighten the terminal securely. Repeat this procedure for the Right Channel.

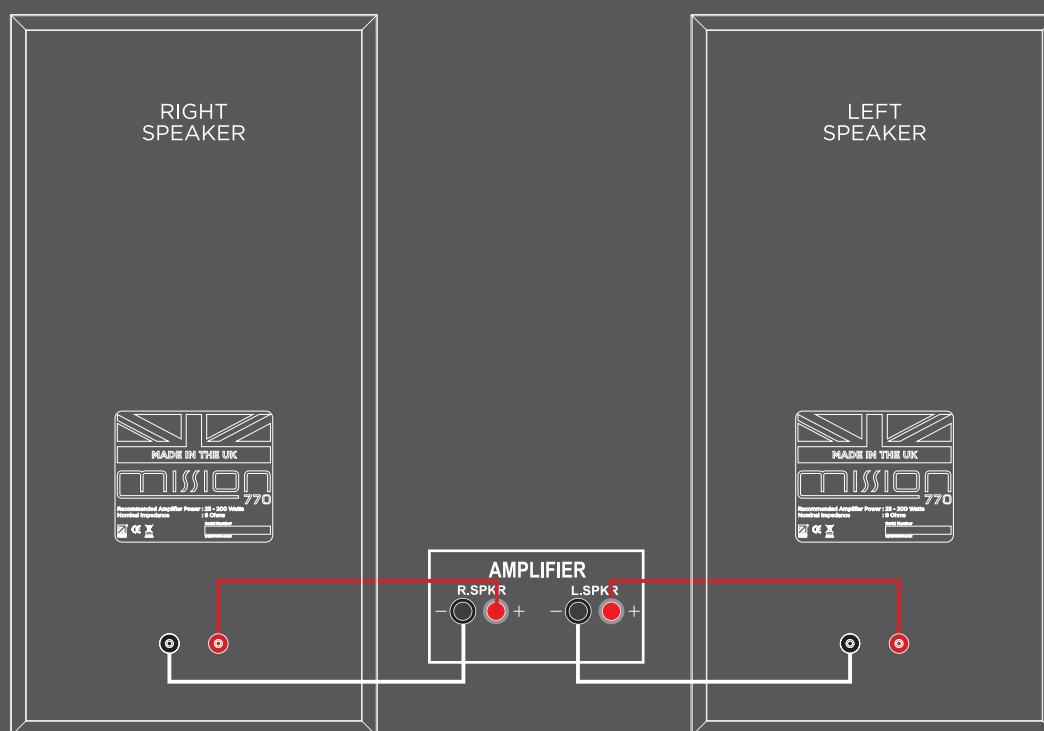

## Looking After Your Loudspeaker

- These speakers are hand-finished with a varnish coating. As with all real wood furniture finishes; exposure to direct sunlight, heat, cold and varying humidity can affect the natural properties of the speaker cabinet. We advise protecting the speaker from extreme variances in temperature and environmental conditions.
- We advise that you do not place anything on the surface of the cabinets, to protect from damage. Treated with care, the veneer finish will last a lifetime. They will age naturally and subtly, retaining the properties of the beautiful high gloss wood finish.
- Your Mission loudspeakers use an especially hardwearing sealed finish. They should not be waxed or treated with spray polishes which will smear and dim their lustrous finish. Polish them with a dry or barely moist cloth to remove dust and finger marks, etc.
- Occasionally, remove the loudspeaker grilles and brush them gently with a soft brush before replacing them carefully.
- Avoid getting any liquid behind the grille. If you accidentally spill liquid on your loudspeakers, take them to your dealer for attention before using them again.



# Warranty Coverage

Your loudspeakers have been constructed to the highest standards. From top grade furniture construction and finish to carefully designed and selected acoustic components, Mission speakers are built to provide a lifetime of sonic pleasure. We hope you will derive many years of good service from our products.

Mission warrants its products, subject to the following terms and conditions below, to be free from defects in materials and workmanship.

## Online Registration



Scan the QR code using a smart-phone device, for product warranty registration online.

- The three (3) year extended warranty is applicable to items purchased from Jan 1st 2021, onwards. Items purchased prior to this date are not eligible for this extended warranty service but are subject to statutory warranty claims and all applicable consumer rights.
- To qualify for the extended 3 year warranty, you must register your product within ninety (90) calendar days from the date of purchase. Visit [mission.co.uk/warranty-registration](https://mission.co.uk/warranty-registration) to complete your online registration. Items not registered online will have a Limited Warranty for one (1) year, or for the period of your country's statutory warranty, whichever is longer.
- Warranty can only be offered to products registered with proof of purchase with date, model and details of the authorised dealer clearly stated on the receipt/invoice. Please keep the original receipt/invoice in case it is required for a warranty claim.
- This Limited Warranty is non-transferable and is offered exclusively to the original owner.
- This Limited Warranty is valid only in the original country of purchase.
- Repairs or replacements are provided under this warranty are the exclusive remedy of the consumer. Mission shall not be liable for any incidental or consequential damages for breach of any express or implied warranty with any product. Except to the extent prohibited by law, this warranty is exclusive and in lieu of all other warranties whatsoever, both expressed and implied, including but not limited to the warrant of merchantability and fitness for practical purpose.

This warranty provides benefits that are additional to and do not affect your statutory consumer rights.

- This Limited Warranty offer is subject to correct information being submitted in your application. Incorrect dates or mismatched purchase receipt dates that are outside of the warranty terms will immediately invalidate any warranty claim.

\*Please check with your dealer local distributor for further information.

# Warranty Coverage

## Exclusions

- The following items are excluded from the Mission warranty:
  - Normal wear and tear and cosmetic damage (including but not limited to any wear from reasonable use, environmental deterioration or neglect)
  - Products on which the serial number has been removed, altered or otherwise made illegible.
  - Products not purchased from an authorised Mission dealer.
  - Products that were not new at the time of original purchase.
  - Products sold 'as is', 'as seen' or 'with faults'
  - Product not purchased from an Authorised Dealer/Distributor within the region of the claim (ie parallel imports or grey market products)
  - Accidental damage or faults caused by commercial use, acts of God, incorrect installation, incorrect connection, incorrect packaging, misuse or careless operation or handling which is not in accordance with the user instructions.
  - Equipment that has been operated in conjunction with unsuitable, inappropriate or faulty apparatus.
  - Repairs, alterations or modifications carried out by parties other than Mission or its authorised service partners.
  - Damage in transit that cannot be attributable to the fault of Mission, the authorised distributor or dealer (ie. claims otherwise covered by transit insurance.)
  - Faults relating to abnormal or inappropriate power supply voltage or power surges.
  - Faults relating to extremities in temperature, exposure to heat, water or other liquids, insects, excessive moisture, sand, chemicals, battery leakage or any other contaminants.
  - Any force majeure events, including but not limited to any acts of God, fire, lightning, typhoon, storm, earthquake, hurricane, natural disaster, tsunami, flood, war, riot, public disturbance.
  - Any other causes beyond the reasonable control of either Mission and its Authorised Distributor.
- Please note items purchased before 1st Jan 2021 are not eligible for the extended warranty claim.

## How to Claim

- To obtain warranty service please contact the authorised dealer from which you purchased this product and present the limited warranty certificate offered upon registration of your product's extended warranty offer.
- Do not dispatch goods without the prior agreement of the dealer distributor or authorised service centre.
- If asked to return products for inspection and or repair, please pack carefully preferably in the original carton or packaging affording an equal degree of protection and returned via insured, trackable courier service.
- The authorised dealer or distributor will offer full return details and instructions. However, please note if unsuitable packaging is used the warranty may be deemed void due to improper action in return.
- Mission or the authorised distributor, dealer or service centre may make a charge for the supply of new packaging for the return of the repaired item. Please note, insurance is recommended as goods are returned at the owner's risk. Authorised distributors or service centres cannot be held liable for loss or damage in transit. Insurance and freight charges on the return journey will be paid for by Mission, authorised dealer, distributor or service centre if corrective work proves to be necessary.
- In the event of 'no-fault found' or 'no repair necessary,' the return shipping charge will be the responsibility of the owner.

# Warranty Coverage

## Repairs

- All repairs will be carried out by the appointed distributor (or locally appointed service centre). Repairs handled or processed without authorisation or approval of the appointed representative will be excluded from this limited warranty. Please note, Mission is not able to supply parts or replacement items to any other entity than the official distributor or authorised service centre.
- Other than the warranty and services set out in this warranty, to the fullest extent permitted by law, Mission shall not be liable to you and/or any third party or entity whatsoever for:
  - Any loss, damages and/or malfunction caused to any product(s) which is/are connected to any of the products covered by this warranty.
  - Any damages, loss and liability, whether direct, indirect, incidental, consequential special, punitive or otherwise, howsoever caused by, arising out of or otherwise, in relation to the installation, delivery, use, service, repair, replacement and/or maintenance of the product;
  - Any damages, loss and liability under this warranty in respect of any act, omission, or negligence of any of their technicians, employees, agents, representatives or independent contractors relating to the actual or purported performance of any of the obligations under this warranty.

## Service Centre Address

- Should a fault occur with your loudspeakers, please pack it correctly, using the original packing, so you can ship it safely. Product for service should be returned to the appointed dealer from whom you purchased the product. If you experience difficulties or there is no Mission dealer in your area, contact the Mission distributor or the office below.

IAG Service Dept.  
13/14 Glebe Road  
Huntingdon  
Cambridgeshire  
PE29 7DL  
UK  
Tel: +44(0)1480 452561  
Email: [service@mission.co.uk](mailto:service@mission.co.uk)
- For information on other authorised service centres worldwide contact Mission International, UK.
- A world wide distributors list is available on the Mission website: [www.mission.co.uk](http://www.mission.co.uk)

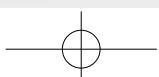
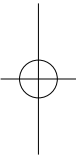
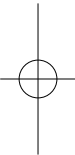
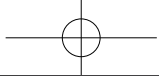

## Specifications

<b>General Description</b>	<b>MISSION 770</b> 2-way vented-box / standmount
<b>Enclosure Type</b>	Bass reflex
<b>Transducer Complement</b>	2-way
<b>Bass Driver</b>	8" (200mm) mineral loaded polypropylene cone
<b>Treble Driver</b>	1.25" (28mm) soft dome
<b>AV Shield</b>	No
<b>Sensitivity (2.83V @1m)</b>	88dB
<b>Recommended Amplifier Power</b>	25-200W
<b>Peak SPL</b>	117dB
<b>Nominal Impedance</b>	8Ω
<b>Minimum Impedance</b>	6Ω
<b>Frequency Response (+/-3dB)</b>	42Hz ~ 20kHz
<b>Bass Extension (-6dB)</b>	30Hz
<b>Crossover Frequency</b>	2.9kHz
<b>Cabinet Volume (in litres)</b>	38.5L

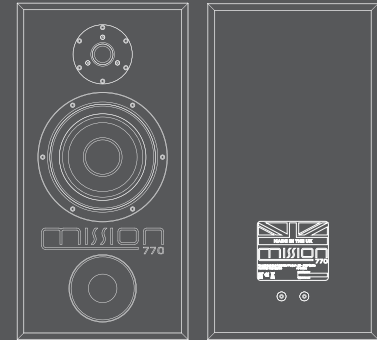

<b>Dimensions (mm)</b>	
<b>Height (on plinth)</b>	590mm
<b>Width</b>	300mm
<b>Depth (with terminals)</b>	(300+22)mm
<b>Carton Size</b>	440 x 430 x 725mm
<b>Net Weight</b>	19.2kg/pcs

<b>Columns</b>	<b>MISSION 770 Stand</b> High carbon steel with internal damping
<b>Top Plate</b>	High carbon steel
<b>Base Frame</b>	Interlocked high carbon steel tube
<b>Base Spikes</b>	Hardened stainless steel

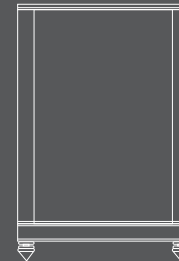

<b>Dimensions (mm)</b>	
<b>Height (on spikes)</b>	445mm
<b>Width</b>	300mm
<b>Depth</b>	300mm
<b>Top Plate (W x D)</b>	300 x 300mm

<b>Carton Size</b>	400 x 300 x 670mm
<b>Net Weight</b>	8kg/pcs
<b>Gross Weight</b>	17.9kg/ctn



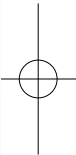
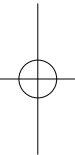



# Music Leads, Technology Follows

 [www.mission.co.uk](http://www.mission.co.uk)

 missionhifi

 Mission HiFi Official

 missionhifi

 missionhifi

**MISSION**

IAG House, 13/14 Glebe Road, Huntingdon, Cambridgeshire, PE29 7DL, UK  
Telephone: +44(0)1480 452561 Email: [service@mission.co.uk](mailto:service@mission.co.uk)

IAG reserves the right to alter the design and specifications without notice. All rights reserved © IAG Group Ltd.  
Mission is a member of the International Audio Group.