

# CONO

PENDANT W/ 2 SHADES

INSTRUCTIONS MANUAL

W0UD

# STEP 1

DECIDE THE LENGTH OF THE CORD AND MOUNT THE CEILING ROSE BRACKET USING THE WALL PLUGS AND SCREWS.

EU / SAA

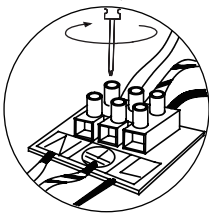
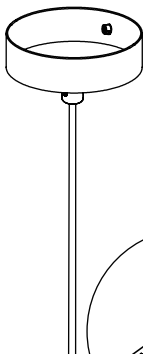
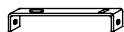
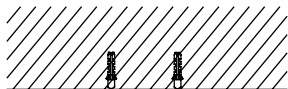

cUL

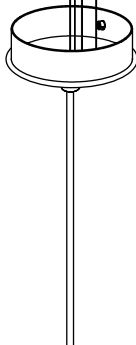
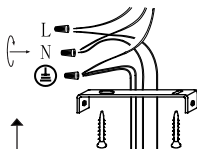
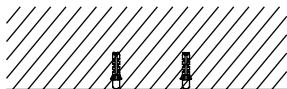

## STEP 2

MOUNT THE CEILING ROSE TO THE BRACKET USING THE SMALL SCREW BOLTS. THEN INSERT SUITABLE LIGHT BULBS.

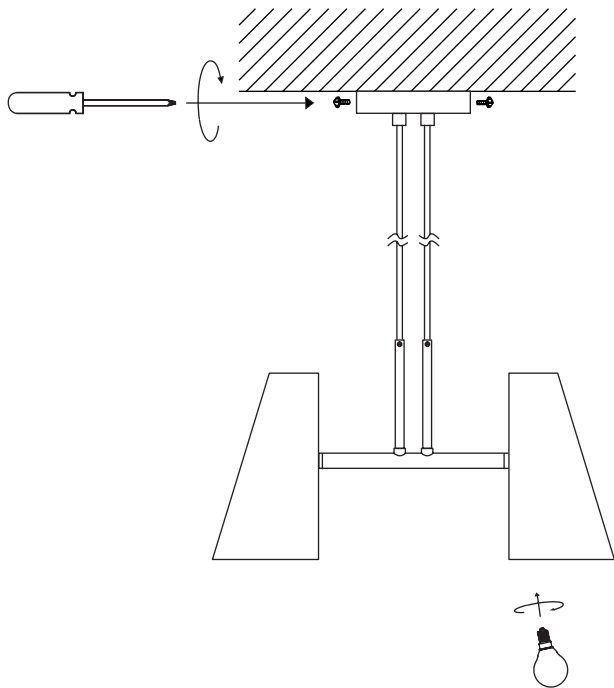

# **SAFETY INSTRUCTIONS**



**IF THE EXTERNAL FLEXIBLE CABLE OR CORD OF THIS LUMINAIRE IS DAMAGED, IT SHALL BE EXCLUSIVELY REPLACED BY THE MANUFACTURER OR SIMILAR QUALIFIED PERSON IN ORDER TO AVOID A HAZARD.**

**THE LAMP IS ONLY INTENDED FOR INTERIOR USE.**

**LAMP EXTERIOR CAN GET HOT AFTER PROLONGED USE.**

**ENSURE BULB HAS FULLY COOLED BEFORE ATTEMPTING TO REMOVE IT.**

**PROTECT FROM CONTACT WITH LIQUIDS.**

**DO NOT PLACE THE CABLE IN REACH OF SMALL CHILDREN OR ANYWHERE THERE IS A RISK OF FALLING OVER IT.**

**WARNING: MUST BE INSTALLED BY A LICENCED ELECTRICIAN.**