

M102-419-202 EDGE DINING TABLE

MORDEN EDGE

ASSEMBLY INSTRUCTIONS

TWO(2)PEOPLE REQUIRED

PLEASE UNPACK ALL PARTS AND CHECK AGAINST PARTS LIST ON THIS INSTRUCTION SHEET BEFORE DISCARDING PACKING AND CARTON!!





1. Turn the table top face down on a smooth, soft surface.
2. Attach the 4 Leg using the Bolt, Flat washer, Lock Washer (C.B.A.). See the Diagram A. Diagram B.

Noted: The Part "Cabinet" is used for Assembly instruction only, not for replacement part;

*** NOTE KEEP THIS SHEET!!! ***

In the unlikely event that you would need a replacement part for your **furniture**, please contact your local authorized Schnadig International dealer. If you need replacement hardware quickly, it could be purchased from your local hardware store.

M103-419-202		
Geometric Cocktail Table		
Part Description	Part No.	QTY
Rectangular Table Leaf	M102-419-202-4051	1
Leg	M102-419-202-4015	4
Nail-in Floor Glide	M102-419-202-4003	8
RTA Hardware	M102-419-202-4001	1

RTA Hardware			
Hardware List			
			Qty
A		Bolt 5/16"*2-1/4"	8
B		Flat Washer: 5/16"	8
C		Lock Washer:5/16"	8
D		Wrench	1

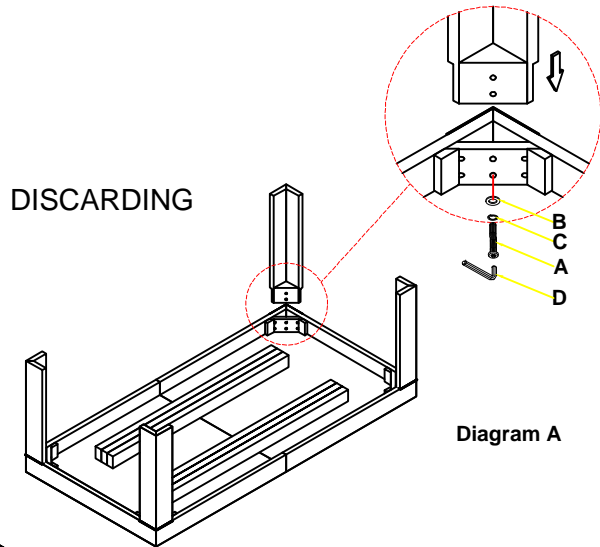

Diagram A

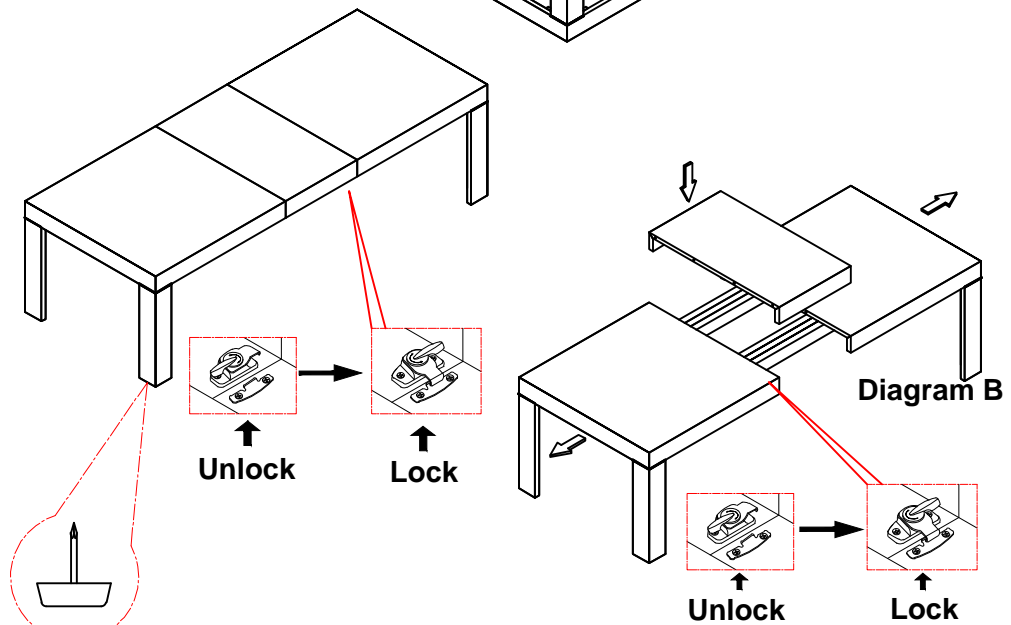
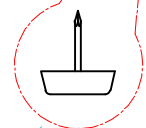

Diagram B



Nail-in Floor Glide