

KHC-022-102-122H/F/R UPHOLSTERED QUEEN/KING BED

HOUSE OF HOPPEN

ASSEMBLY INSTRUCTIONS

TWO (2) PEOPLE AND PHILIP'S SCREWDRIVER REQUIRED







PLEASE UNPACK ALL PARTS AND CHECK AGAINST PARTS LIST ON THIS INSTRUCTION SHEET BEFORE DISCARDING PACKING AND CARTON!!

- 1) Connect the side rails and headboard / footboard by bolt (F).
- 2) Assemble the side rails and headboard / footboard using the curved washer (A), flat washer (B), lock washer (C), and nut (D) tighten with wrench provided (E), as shown in Diagram A.
- 3) Assemble the support leg on the bottom rail of headboard & footboard as shown in Diagram B.
- 4) Attach the center support rail on the Cleat of headboard & footboard, Using Philips' screw driver to tighten the screw (N)as shown in diagram C.
- 5) Attach the bed slats on the center support rail and cleat of side rails then using Philips' screw driver to tighten the screw (N)as shown in diagram D.

*** NOTE KEEP THIS SHEET!!! ***

In the unlikely event that you would need a replacement part for your furniture, please contact your local authorized Caracole International dealer. If you need replacement hardware quickly, it could be purchased from your local hardware store.

Part Description	KHC-022-102H/F/R QUEEN BED		KHC-022-122H/F/R KING BED	
	Part No.	QTY	Part No.	QTY
Headboard (1)	KHC-022-102H	1	KHC-022-122H	1
Footboard (2)	KHC-022-102F	1	KHC-022-122F	1
Side Rail (3)	KHC-022-102R	2	KHC-022-122R	2
Center Support Rail (4)	KHC-022-102R	1	KHC-022-122R	2
Slat (5)	KHC-022-102-F-3067	11	KHC-022-102-F-3067	11
Support leg(6)	KHC-022-102-F-30305	2	KHC-022-122-F-30305	4
RTA Hardware(7)	KHC-022-102-R-3001	1	KHC-022-102-R-3001	1
RTA Hardware(8)	KHC-022-102-F-3001	1	KHC-022-122-F-3001	1

RTA Hardware For Side rail (7)			
NO.	Hardware List	Q'ty	
A	 Curved Washer	8	
B	 Flat Washer(5/16")	8	
C	 Lock Washer(5/16")	8	
D	 Nut	8	
E	 Wrench	1	
F	 Bolt (5/16"X85MM)	8	
N	 Screw(4.2x32MM)	4	

RTA Hardware for bed slats of QN Bed (8)			
N	 Screw(4.2x32MM)	55	

RTA Hardware for bed slats of KG Bed (8)			
N	 Screw(4.2x32MM)	66	

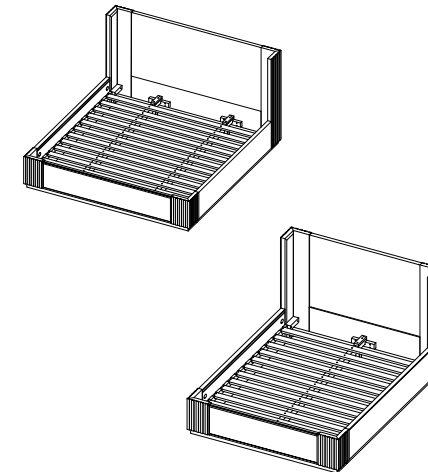

KHC-022-102-122H/F/R UPHOLSTERED QUEEN/KING BED

HOUSE OF HOPPEN

