

CON-COCTAB-014 SOCIABLES
CARACOLE CONTEMPORARY

ASSEMBLY INSTRUCTIONS
TWO PEOPLE REQUIRED

UNPACK ALL PARTS AND CHECK THEM AGAINST PARTS LIST ON THIS INSTRUCTION SHEET BEFORE DISCARDING PACKING AND CARTON!!

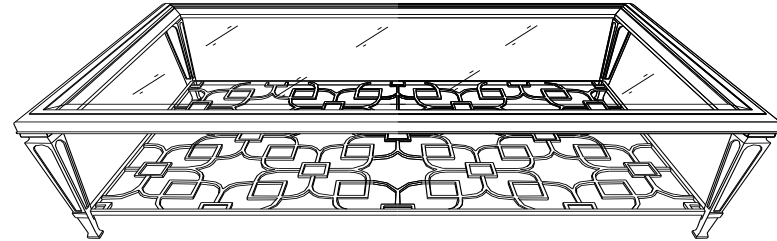



- 1) Secure metal base to leg using the bolts(A), tighten the bolts with wrench (E) until stretcher is fully assembly (see step 1 on Drawing A)
- 2) Turn the top upside down on a soft clean surface. Secure leg to top using the bolt(B),lock washer(C) and flat washers (D),tighten the bolts with wrench (E).(See step 2 on drawing A)
- 3) Assembly middle support leg on metal base by wrench (E). (see step 3 on drawing A)
- 4) Put the glass top on the top frame(See step 4 on drawing A)
- 5) To level the Table , adjust the levelers on the bottom of each foot.



***** NOTE KEEP THIS SHEET!!!**

In the unlikely event that you would need a replacement part for your furniture, please fax this sheet to our CSR at 1-800-848-8930 with your order or call 1-800-468-8730. If you need replacement hardware quickly,it could be purchased from your local hardware store.

CON-COCTAB-014		
SOCIABLES		
Part Description	Part No.	QTY
Top Frame	CON-COCTAB-014-40307	1
Legs	CON-COCTAB-014-4018	4
Bottom shelf	CON-COCTAB-014-4027	1
Middle support leg	CON-COCTAB-014-40305	1
Glass TOP	CON-COCTAB-014-4029	1
Levelers	CON-COCTAB-014-4075	5
RTA Hardware	CON-COCTAB-014-4001	1

RTA Hardware			
Hardware List			Qty
A		DIA 1/4"X 5/8" Flat head Bolt	4
B		DIA 1/4"X 1-1/8" Bolt	8
C		DIA1/4" lock washer	8
D		DIA 1/4" X 16mm flat washer	8
E		4mm Allen Wrench	1
F		M1/4"X3/8FLAT HEAD BOLT	2

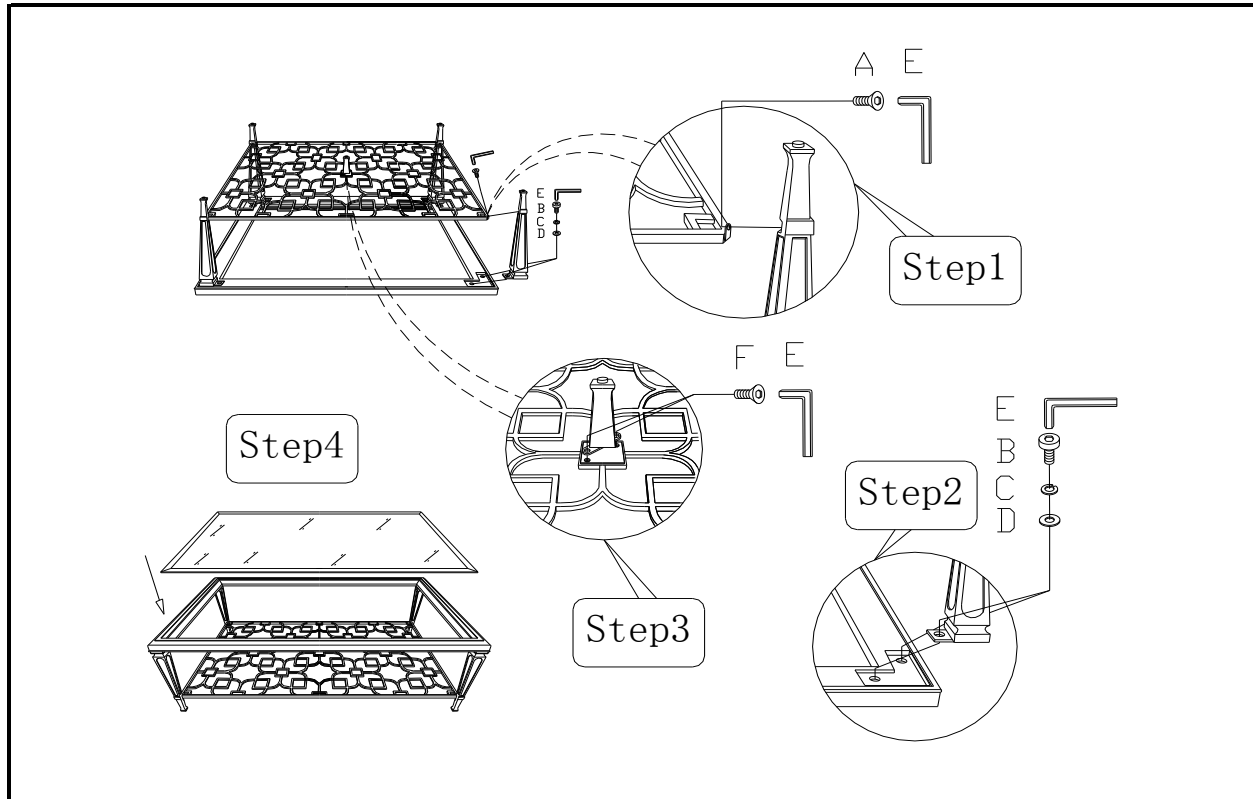

Drawing A