

# CLA-422-413 OCULUS CARACOLE CLASSIC

## ASSEMBLY INSTRUCTIONS

PLEASE UNPACK ALL PARTS AND CHECK AGAINST PARTS LIST ON THIS INSTRUCTION SHEET BEFORE DISCARDING PACKING AND CARTON!!







- 1) Turn the table top face down on a smooth ,soft surface.
- 2) Attach legs to table top using the flat washer (A), lock washer (B) and bolt (C), tighten with wrench provided (D),as shown in Diagram A&B.
- 3) Turn the table to upright position.

**Note:** Touch-up pen is provided for repair of minor issues resulting from transit, handling and normal use.

\*\*\* NOTE KEEP THIS SHEET!!! \*\*\*

In the unlikely event that you would need a replacement, please contact your local authorized Caracole dealer.

CLA-422-413		
<b>OCULUS</b>		
Part Description	Part No.	QTY
Top Face	CLA-422-413-50171	1
Shelf	CLA-422-413-50116	1
Upper Leg	CLA-422-413-50117	3
Glass Shelf	CLA-422-413-5028	1
Touch -up Pen	CLA-422-413-50439	1
RTA Hardware (1)	CLA-422-413-5001	1

RTA Hardware (1)			
Hardware List			Q'ty
A		Flat Washer: 5/16	12
B		Lock Washer: 5/16	12
C		Bolt 5/16(in)x35(mm)	12
D		Wrench	1
E		Shelf Support with Hole	3
F		Clear Bumper	3

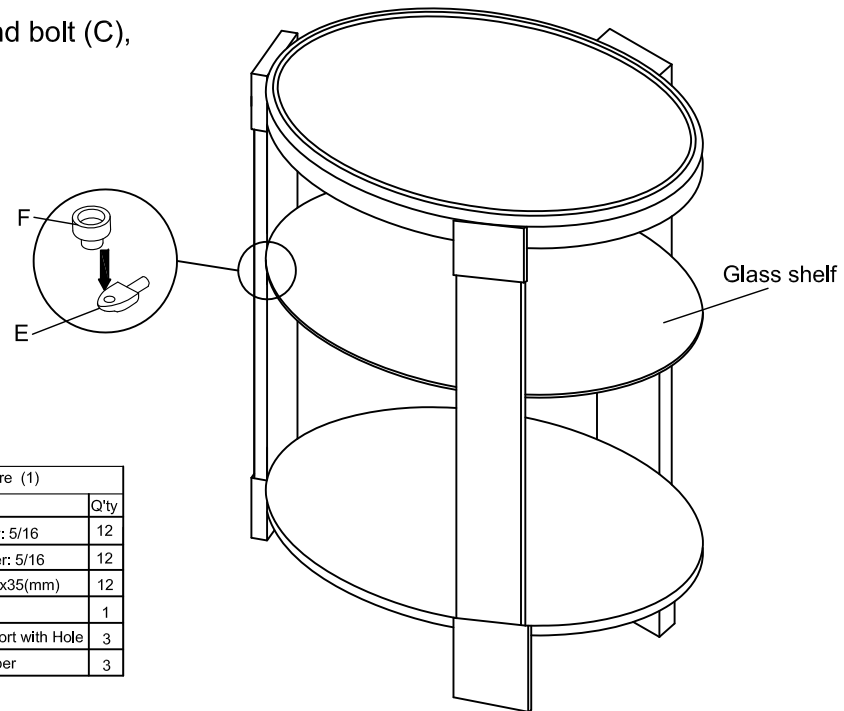

Diagram A  
Diagram B

