

# CLA-418-413 SOCIAL CIRCLE

## CARACOLE CLASSIC

### ASSEMBLY INSTRUCTIONS





**PLEASE UNPACK ALL PARTS AND CHECK QUANTITY AGAINST PARTS LIST BEFORE DISCARDING PACKING CARTON!**

- 1) Secure the bottom metal shelf to the legs with the screws(A), and the wrench(E).
- 2) Turn the top upside down on a soft clean surface. Secure the leg leg to the back side of the top with the screws(B), with the spring washer(C), the flat washers(D), and the wrench(E).
- 3) Put the plastic bumpers(G) onto the inset of the top frame.
- 4) To level the Table, adjust the levelers on the bottom of each foot.

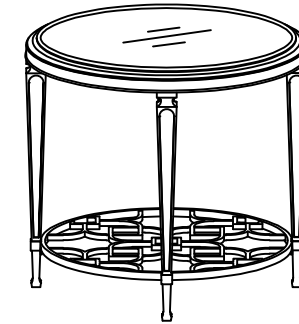
\*\*\* NOTE KEEP THIS SHEET \*\*\*

In the unlikely event that you would need a replacement part for your furniture, please contact your local authorized Schnadig International dealer. If you need replacement hardware quickly, it could be purchased from your local hardware store.



CLA-418-413				
<b>SOCIAL CIRCLE</b>				
Part List				
NO.	Hardware List		Part Number	QTY
1		Top Frame	CLA-418-413--0307	1
2		Glass Top	CLA-418-413-029	1
3		Bottom Shelf	CLA-418-413-027	1
4		Leg	CLA-418-413-018	4
5		Adjustable Floor Glide	CLA-418-413-075	4

RTA Hardware				
Hardware List				QTY
A		Screws	DIA 1/4"*5/8"	4
B		Screws	DIA 1/4"*1-1/8"	8
C		Spring Washer	DIA 1/4"	8
D		Flat Washer	DIA 1/4"*16mm	8
E		Allen Wrench	4mm	1
F		Glear Bumper		4

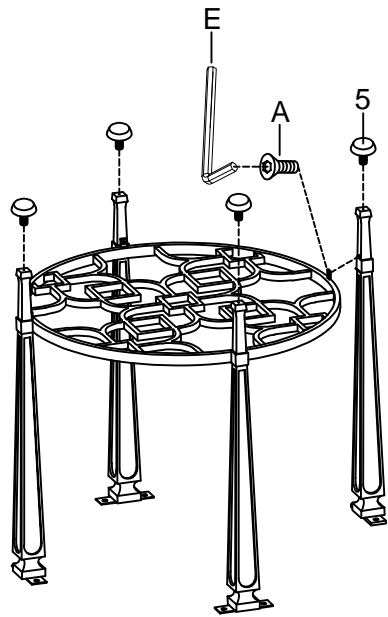

STEP 1

STEP 3

STEP 2

