

CLA-017-442 SLIM CHANGE CARACOLE CLASSIC

ASSEMBLY INSTRUCTIONS
TWO (2) PEOPLE REQUIRED







PLEASE UNPACK ALL PARTS AND CHECK AGAINST PARTS LIST ON THIS INSTRUCTION SHEET BEFORE DISCARDING PACKING AND CARTON!!

1. Face down the table on a soft, cleaning surface.
2. Loosely assemble the stretcher with front legs and back legs using bolt (E) and wrench provided (F) as shown in diagram A.
3. Attach legs & stretcher assembled to table top using flat washer (A), lock washer (B) and bolt (C), tighten with wrench provided (D) as shown in diagram A.
4. Tighten all the bolts and turn the table to upright position.

*** NOTE KEEP THIS SHEET!!! ***

In the unlikely event that you would need a replacement part for your table, please contact your local authorized Schnadig International dealer. If you need replacement hardware quickly, it could be purchased from your local hardware store.

Part Description	CLA-017-442	
	SLIM CHANGE Part No.	QTY
Drawer Pull	CLA-017-066-3081	2
Drawer Guide	CLA-017-442-20350	1set
RSF Front Leg	CLA-017-442-2066	1
RSF Back Leg	CLA-017-442-20431	1
LSF Front Leg	CLA-017-442-2065	1
LSF Back Leg	CLA-017-442-20430	1
RTA Hardware	CLA-017-442-2001	1
Stretcher w/screws	CLA-017-442-20166	1
Nail-in Floor Glide	CLA-017-066-3086	4

RTA Hardware		
Hardware List	Qty	
A 	Flat Washer: 5/16	8
B 	Lock Washer: 5/16	8
C 	Bolt 5/16(in)x58(mm)	8
D 	Wrench	1
E 	Bolt 1/4(in)x8(mm)	4
F 	Wrench	1

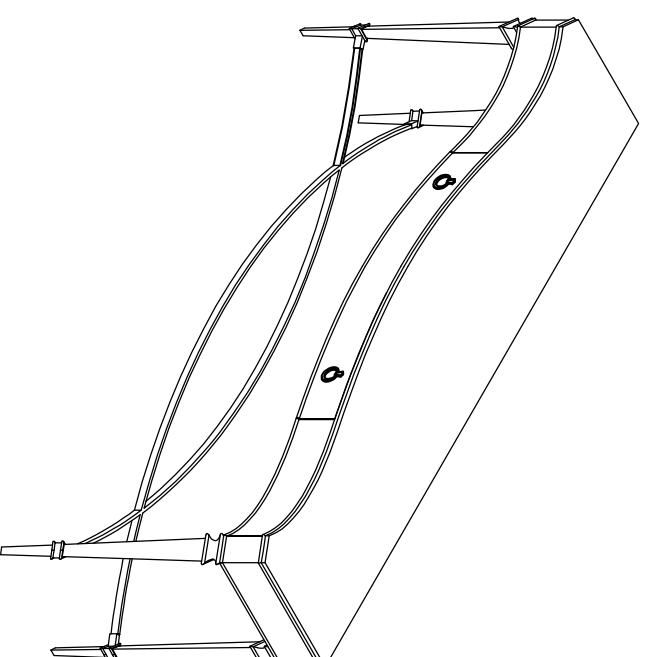

Diagram A

