

**CLA-016-811**  
**CARACOLE CLASSIC**

**ASSEMBLY INSTRUCTIONS**

**PLEASE UNPACK ALL PARTS AND CHECK QUANTITY AGAINST PARTS LIST BEFORE DISCARDING PACKING CARTON!**

- 1) Open the carton and inside there are one metal frame and six glass shelves.
- 2) Position the metal frame in a required display location.
- 3) Assemble the L-Shape bracket on the top of the back as the page2 illustration.
- 4) Insert the rubber bumpers into the metal shelves as the page2 illustration.
- 5) Carefully place the glass shelves into the metal shelves.

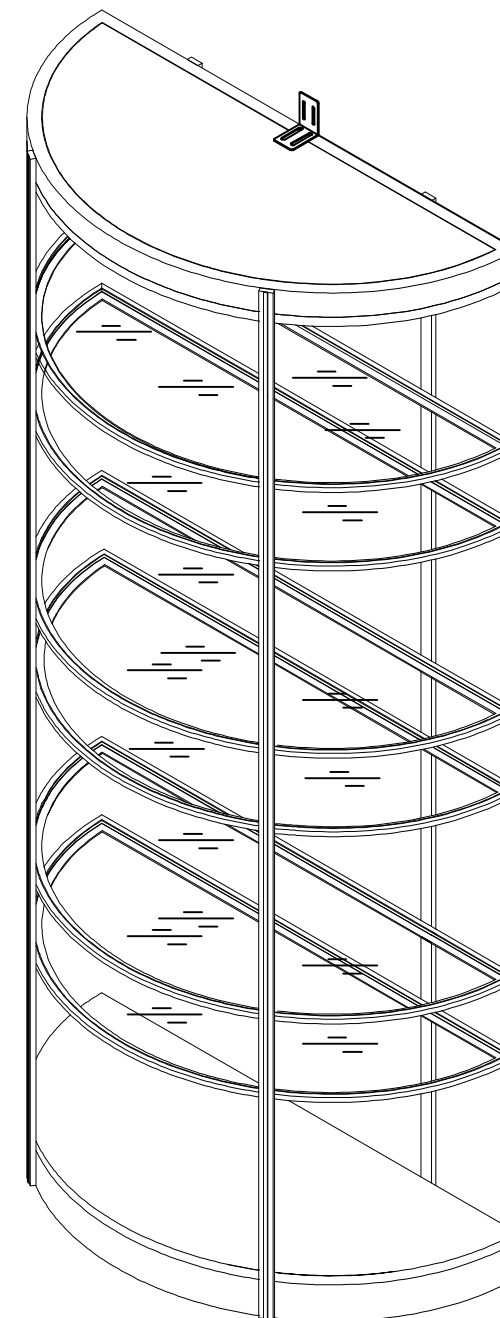





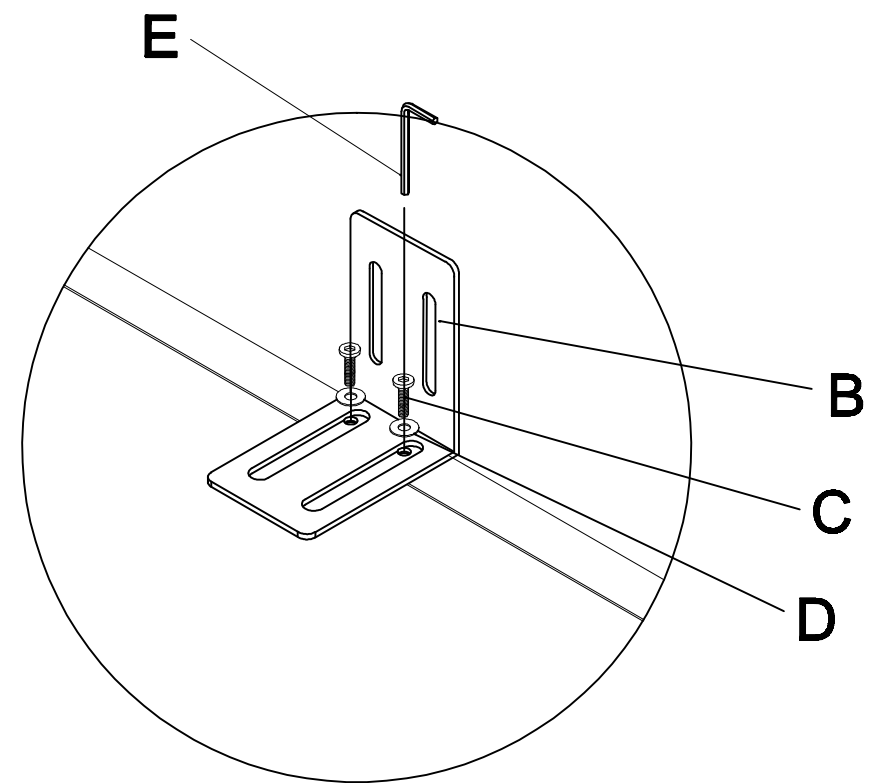
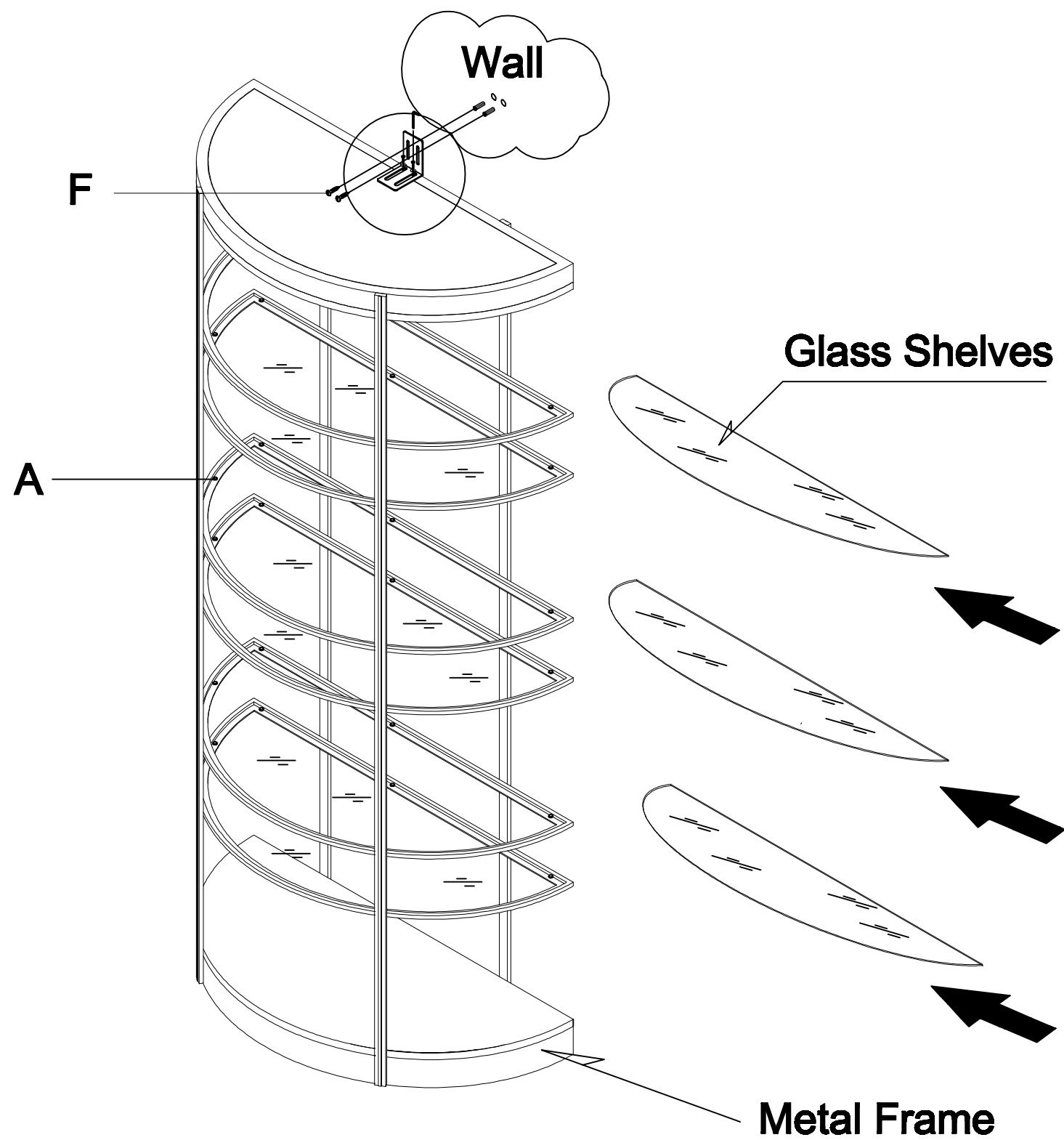

\*\*\* NOTE KEEP THIS SHEET \*\*\*

In the unlikely event that you would need a replacement part for your furniture, please contact your local authorized Schnadig International dealer. If you need replacement hardware quickly, it could be purchased from your local hardware store.

<b><u>CLA-016-811</u></b>		
<b>UP, UP AND AWAY</b>		
Part Description	Part No.	QTY
Glass Shelf	CLA-016-811-028	6
Adjustable Floor Glide	CLA-016-811-003	4
RTA Hardware	CLA-016-811-001	1



RTA Hardware			
Hardware List			QTY
A		Clear Rubber Bumper	24
B		L-Shape Bracket	1
C		Bolt	2
D		Washer	2
E		Wrench	1
F		Screw	2