

Product Manual

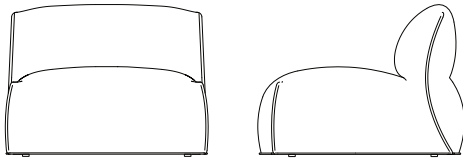

Arke Modular Sofa Designed by Studio Nooi

Version 1.0 - March/2023

Bolia.com

Vaerkmestergade 11-13
8000 Aarhus C, Denmark
+45 51 50 51 22

EN

Read the product manual carefully before using your product. If you do not follow the instructions, there is a risk that you could damage the product or in the worst case cause injury. Keep the product manual for future reference. If the product is later passed on to third parties, this manual must also be provided.



This symbol indicates a warning regarding the care, handling, or use of the product. If such a warning is not followed, there is a risk that you could damage the product, or in the worst case cause injury.

Use the product only for the purpose described in this manual. Any other use does not correspond to the intended purpose of the product and can lead to damage to the product or injuries. The manufacturer or dealer accepts no responsibility for damage resulting from the use of the product in a manner for which it is not intended. Incorrect, improper use of the product can lead to personal injuries. Children must not play with the packaging film, as there is a risk that they will be wrapped up in it and caught. Before using the product, make sure that there is nothing that can harm or injure people.

Risk of damaging the product

Incorrect, improper use, handling and cleaning can damage parts or the entire product. Do not step on or jump on the product. It is not intended for this. Do not use a hard brush, solvent, corrosive or strong cleaning agent to clean the products, if not advised by Bolia.com. Always use recommended care and cleaning products. Never cover wet products. If a wet product is covered, it can be damaged. Further information can be found on our website: Bolia.com

Technical information

As we are constantly developing and improving our products, design and technical changes may occur. This products manual can be downloaded as a PDF file from our website: Bolia.com



Disposal of packaging & product

Dispose of the product and packaging in accordance with local waste regulations. Packaging materials must be separated and disposed of properly.

For user instructions in other languages,
please scan this code





GB: Please tighten the screws/legs after 4-5 weeks of use and then subsequently every 4-5 month.

DK: Spænd skruerne/benene efter 4-5 ugers brug og derefter hver 4.-5. måned

DE: Ziehen Sie die Schrauben/Beine nach 4 bis 5 Wochen Gebrauch und anschließend alle 4 bis 5 Monate nach.

NO: Stram skruene/bena etter 4-5 ukers bruk, og deretter hver 4.-5. måned

SE: Dra åt skruvarna/benen efter 4-5 veckors användning och därefter var 4-5:e månad

NL: Draai de schroeven/poten na 4-5 weken gebruik aan en vervolgens elke 4-5 maanden.

FR: Veuillez resserrer les vis/pieds après 4 à 5 semaines d'utilisation, puis tous les 4 à 5 mois suivants.

ES: Aprieta los tornillos/patas después de 4-5 semanas de uso y posteriormente cada 4-5 meses



GB: CAUTION — KEEP AWAY FROM SMALL CHILDREN. THE THIN FILM MAY CLING TO NOSE AND MOUTH AND PREVENT BREATHING.

DK: FORSIKTIG – OPBEVARES UTILGÆNGELIGT FOR SMÅ BØRN. DEN TYNDE FILM KAN DÆKKE NÆSE OG MUND OG FORHINDRE VEJRTRÆKNING.

DE: VORSICHT – VON KLEINEN KINDERN FERNHALTEN. DIE DÜNNE FOLIE KANN AN NASE UND MUND HAFTEN UND DIE ATMUNG VERHINDERN.

NO: FORSIKTIG – MÅ HOLDES UNNA SMÅ BARN. DEN TYNNE FILMEN KAN KLEBE SEG TIL NESE OG MUNN OG FORHINDRE PUST.

SE: VARNING – FÖRVARA UTOM RÄCKHÅLL FÖR SMÅ BARN. DEN TUNNA FOLIEN KAN FASTNA I NÄSAN OCH MUNNEN OCH ORSAKA KVÄVNING.

NL: LET OP – BUITEN BEREIK VAN KLEINE KINDEREN HOUDEN. DE DUNNE FILM KAN AAN NEUS EN MOND KLEVEN EN DE ADEMHALING VERHINDEREN.

FR: ATTENTION – TENIR HORS DE PORTÉE DES ENFANTS. LE FILM FIN PEUT SE COLLER AU NEZ ET À LA BOUCHE ET EMPÊCHER LA RESPIRATION.

ES: PRECAUCIÓN: MANTENER FUERA DEL ALCANCE DE LOS NIÑOS. EL FINO FILM DE PLÁSTICO PUEDE ADHERIRSE A LA NARIZ Y LA BOCA E IMPEDIR A LOS NIÑOS QUE RESPIREN.



GB: This product is only for outdoor use.

DK: Dette produkt er kun til udendørs brug.

DE: Dieses Produkt darf nur im Freien verwendet werden.

NO: Dette produktet er kun ment for utendørs bruk.

SE: Den här produkten är endast avsedd för utomhusbruk.

NL: Dit product is uitsluitend bedoeld voor gebruik buitenshuis.

FR: Ce produit est uniquement destiné à un usage extérieur.

ES: Este producto es para uso exclusivo en exteriores.



GB: Do not push or drag furniture across the floor – please lift when moving.

DK: Skub eller træk ikke møbler hen over gulvet – løft dem, når du flytter dem.

DE: Schieben oder ziehen Sie Möbel nicht über den Boden – heben Sie sie bitte an, wenn Sie sie bewegen

NO: Ikke skyv eller trekk møblene over gulvet – løft dem når de skal flyttes.

SE: Skjut eller dra inte möbler över golvet – lyft dem vid flytt.

NL: Duw of sleep meubels niet over de vloer – til ze op wanneer u ze verplaatst.

FR: Ne pas pousser ou traîner les meubles sur le sol – veuillez les soulever lorsque vous les déplacez.

ES: No empujes ni arrastres muebles por el suelo, levántalos cuando los muevas.

Max
110 kg
242 lb

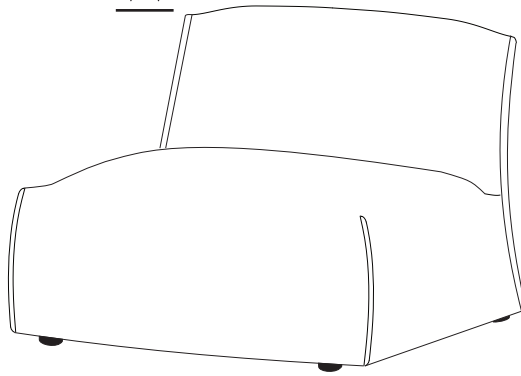

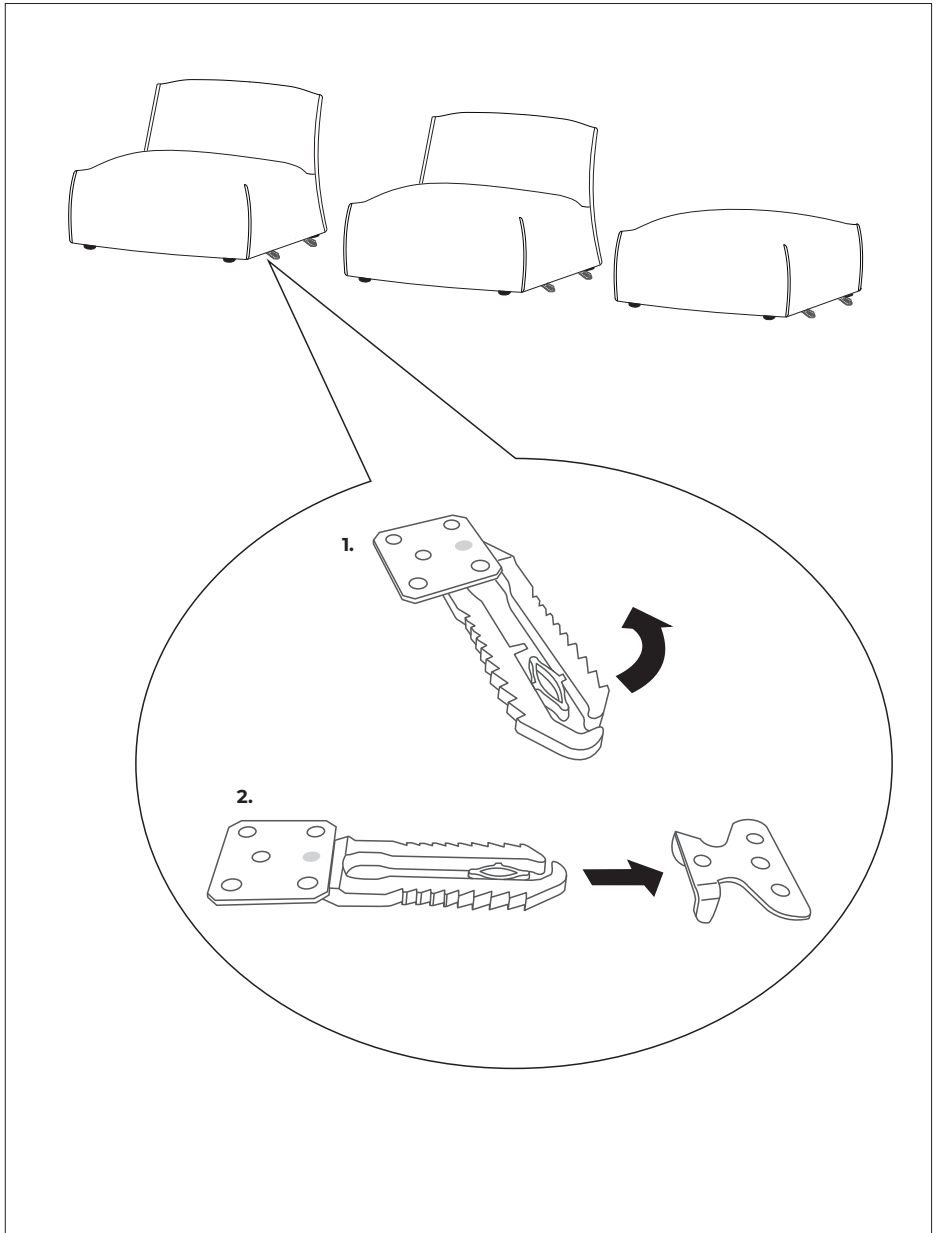

REMOVING REMOVABLE COVER

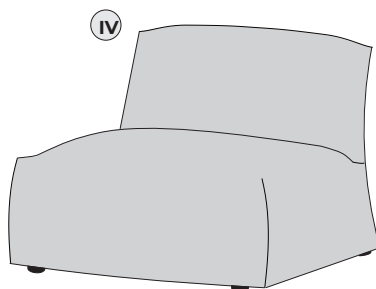
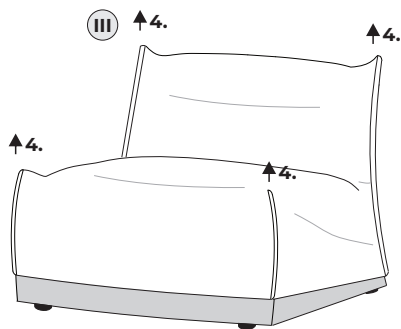
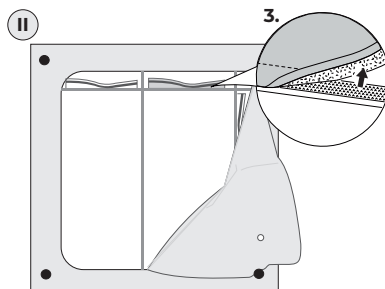
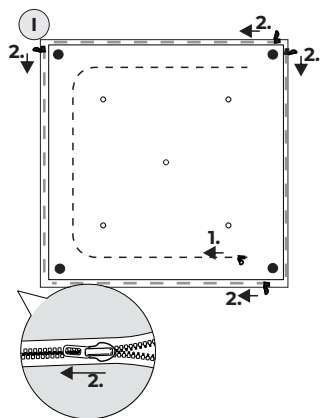

RE-INSTALLING REMOVABLE COVER

