



Item type
Chandelier

Item name
Argento

Item no
111975UL

Attention! Do not connect your luminaire to electricity until it is fully assembled.

Care instructions:

Wipe with a soft dry cloth, do not use chemicals or abrasive cleaning materials.

Eichholtz B.V.

Delfweg 52
2211 VN Noordwijkerhout
The Netherlands

🏠 www.eichholtz.com
✉ service@eichholtz.com
☎ +31 (0)252 515 850

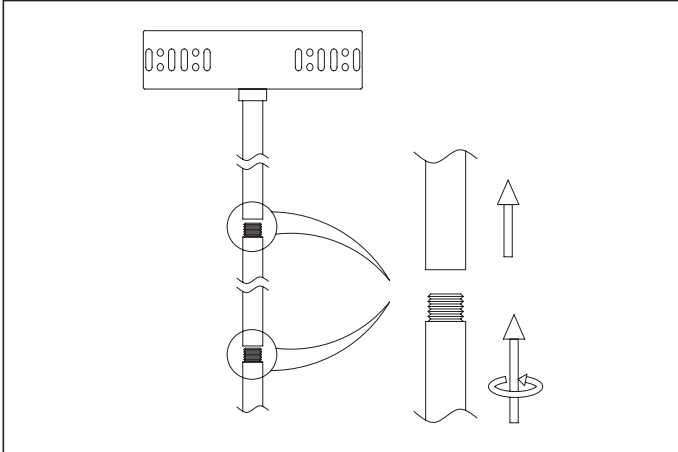

1. Determine the desired height of your chandelier and connect the extension pipes. Thread the wire from the lamp through the pipes. Three pipes are included, extra extension pipes can be ordered.

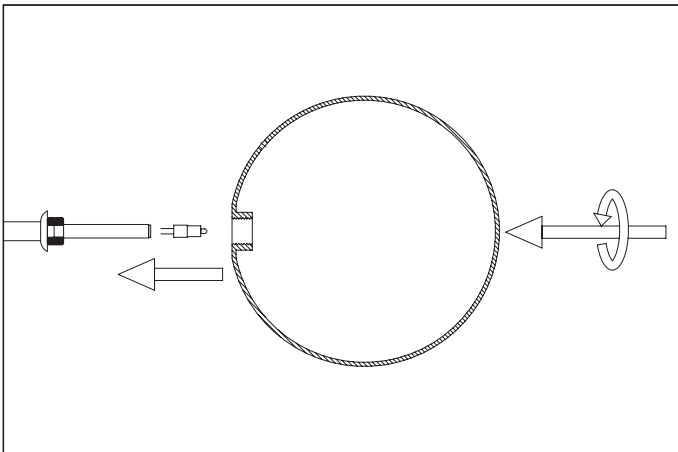

3. Adjust the arms until your luminaire is balanced.

Place the G4 lightbulbs (included) and carefully screw on the glass balls. Do not over tighten as it might cause the glass to break.

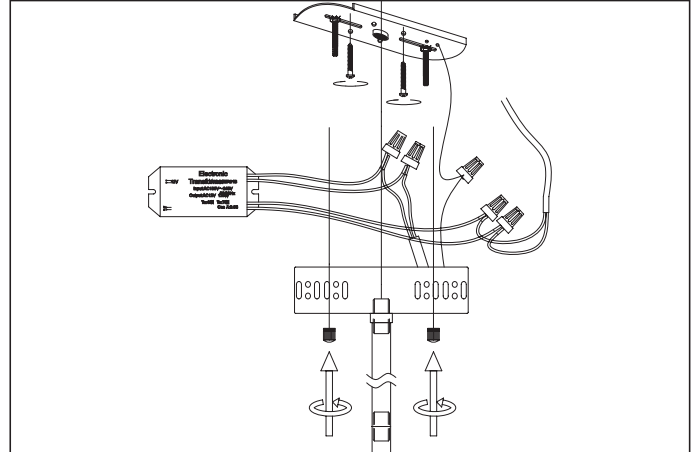

2. Move the arms one by one until the luminaire looks balanced. Final balancing will be done after the luminaire is installed.

Fix the ceiling plate to the ceiling by using mounting plugs and screws suitable to your ceiling type. Guide the wires through the plate. Place or hold the lamp in an elevated position in such a way that the wires can freely reach the ceiling junction box.

Connect the 3 wires according to their markings.

Place the ceiling canopy flush against the ceiling and fix it securely with the two nuts supplied.

The LED driver is suitable to be used in combination with a LED dimmer (not included).