

Item type
Wall Lamp

Item name
Reading

Item no
111511UL

Attention! Do not connect your luminaire to electricity until it is fully assembled.

Care instructions:
Wipe with a soft dry cloth, do not use chemicals or abrasive cleaning materials.

Eichholtz B.V.
Delfweg 52
2211 VN Noordwijkerhout
The Netherlands

🏠 www.eichholtz.com
✉ service@eichholtz.com
☎ +31 (0)252 515 850

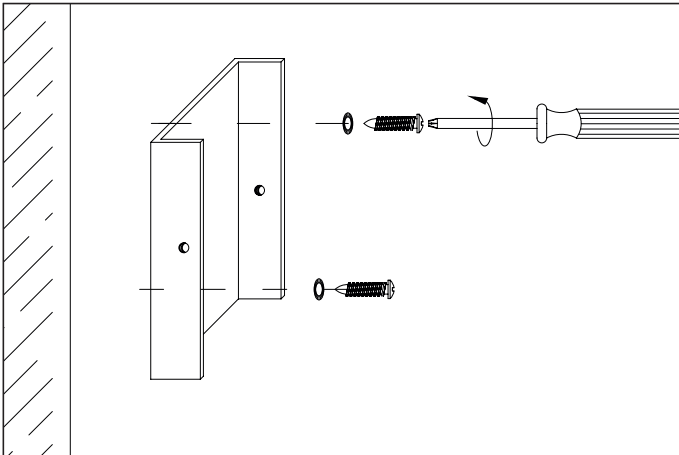

1. Fix the wall plate to the wall by using mounting plugs and screws suitable for your wall.

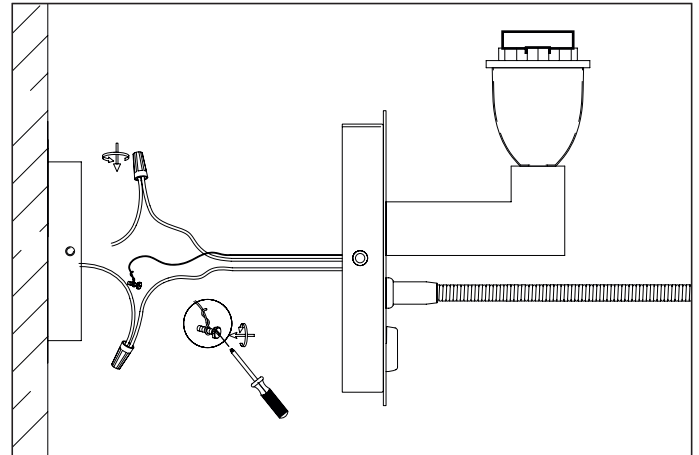

2. Connect the three wires.

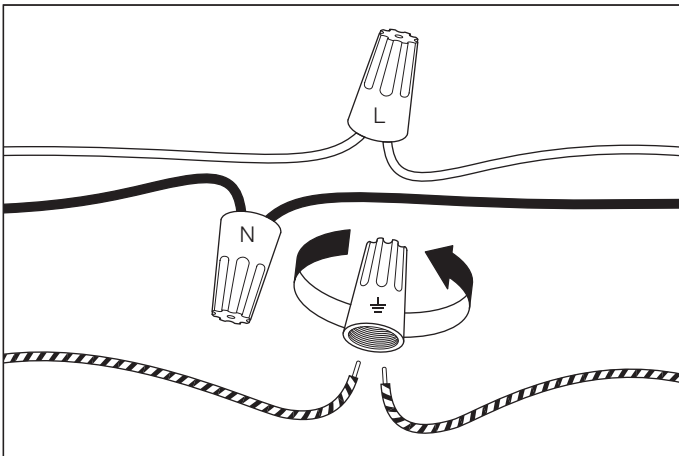

3. L is the live wire, N is the neutral wire. The course wire is the grounding wire.

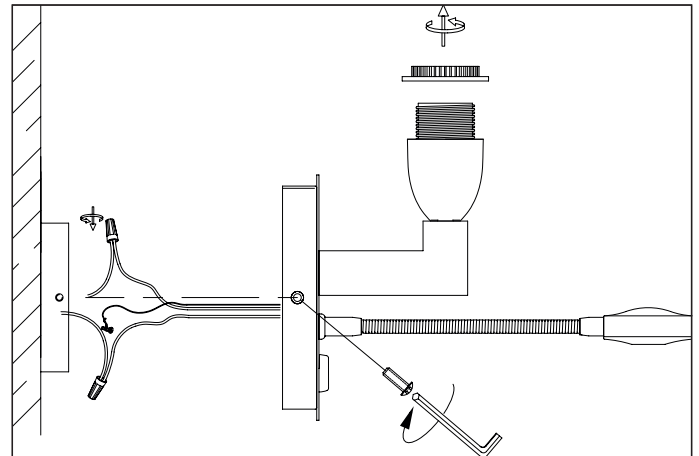

4. Place the lamp over the wall plate and fix it securely with the screws on both sides.

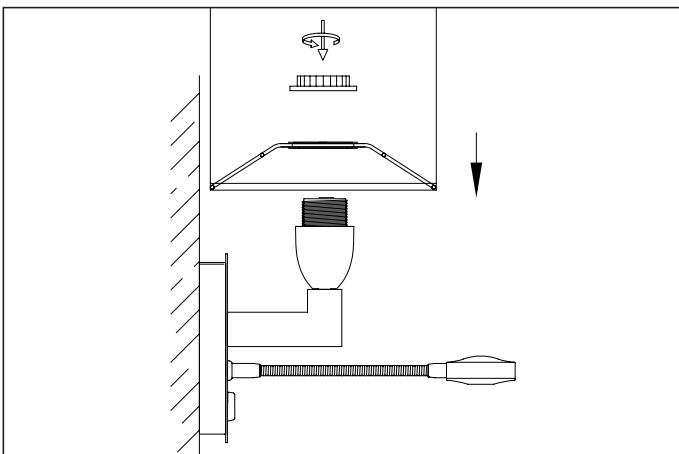

5. Place the shade.

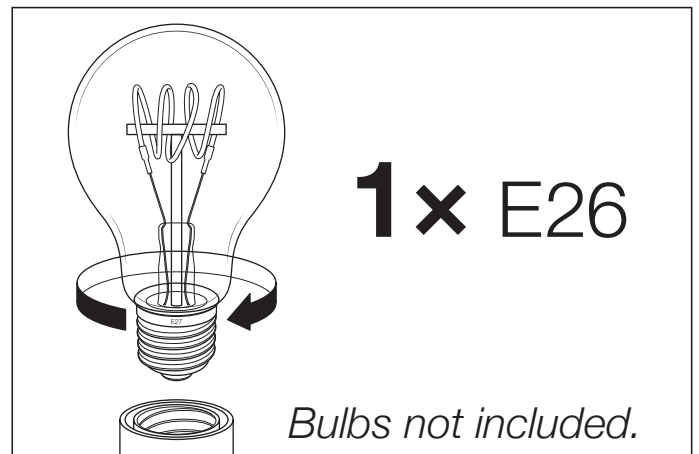

6. Carefully place the bulbs in the fittings. Do NOT turn the bulbs further than necessary, to prevent damage to the fitting.