

Item type

Chandelier

Item name

Commodore

Item no

111305UL

Attention! Do not connect your luminaire to electricity until it is fully assembled.

Care instructions:

Wipe with a soft dry cloth, do not use chemicals or abrasive cleaning materials.

Eichholtz B.V.

Delfweg 52
2211 VN Noordwijkerhout
The Netherlands

🏠 www.eichholtz.com
✉ service@eichholtz.com
☎ +31 (0)252 515 850

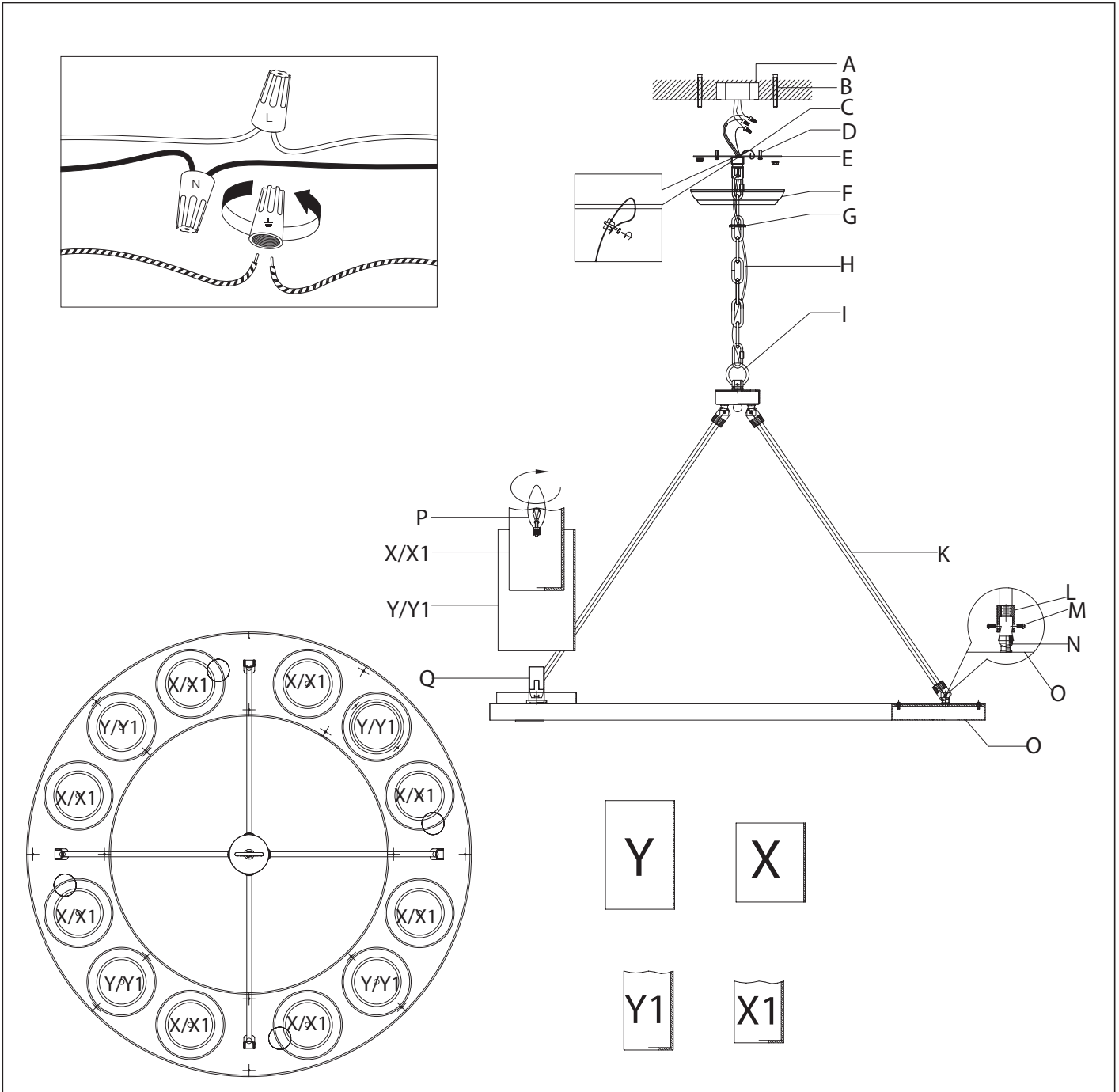

1. Connect two ends of 4 pipes(K) with screws(M).
2. Fix the crossbar by screws(D)and bolts(Y).
3. Connect ring(I) of lampbody and crossbar(E) by chain(H).
4. Connect 3 wires.
5. Fix steel wire to the crossbar with wire lock.
6. Fix the canopy to crossbar by ring(G).
7. Install white shades according to their sizes.
8. Place the bulbs to the lampholders.