

# Swings and Things



Suppliers of a wide range of swings and associated fittings

Phone Tui on 021 128 0521

Visit our website: [www.swingsandthings.co.nz](http://www.swingsandthings.co.nz)

Or contact us at: [swingsandthingsnz@gmail.com](mailto:swingsandthingsnz@gmail.com)

Swings and Things is a small family business, we are the combination of a skilled craftsperson and an early childhood teacher. We have been a manufacturer of specialised outdoor equipment for early childhood centres for 35 years.

We are suppliers of all swing fittings and associated equipment, offering excellent service, advice and expertise on swings and swing frames. We produce a range of quality, innovative swings for the whole family, designed for challenge, physical development, fun and enjoyment with a range of physical and motor development equipment.

Our swings are made from recyclable resources whenever possible. We also provide a rope replacement service.

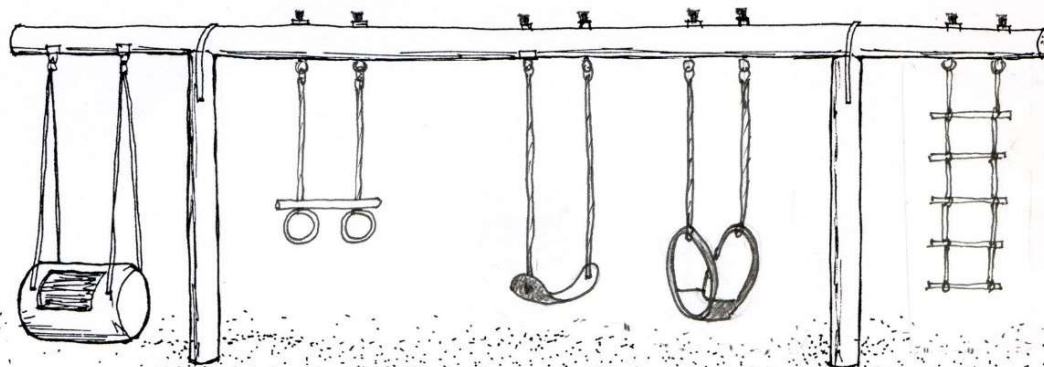

Our range includes 40 different types of swinging equipment.

**Note: The installation and regular maintenance of swings and all fittings are the responsibility of the purchaser.  
All Swings and Things equipment fully complies with NZS5828:2004  
All Prices exclude GST and freight.**



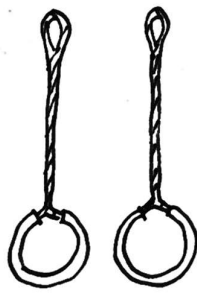

Bar Swing \$72

Roman Swing  
\$72

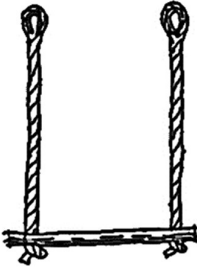

Hand Rings  
\$126



Trapeze Bar  
\$114

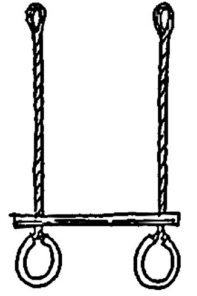

Trapeze Bar with  
Rings \$162

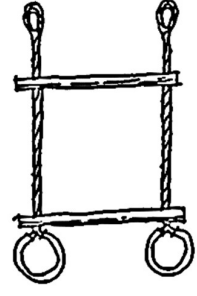

Double Trapeze  
with Rings  
\$174

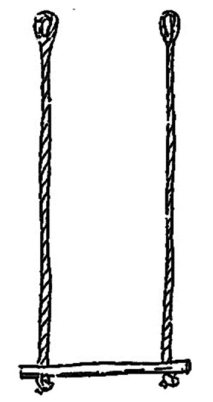

Trapeze Swing  
\$126

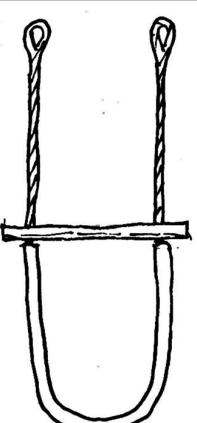

Sabine Swing  
\$162

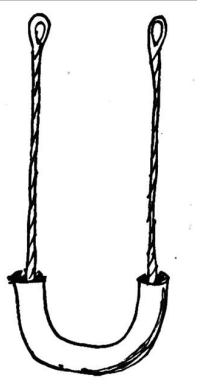

Plastic Tubing  
Swing  
\$126

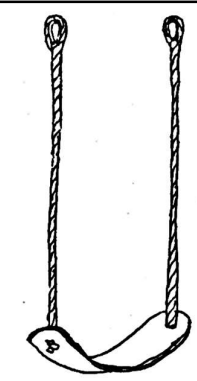

Plastic Strap  
Swing  
\$144

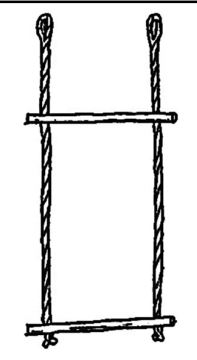

Double trapeze  
Swing  
\$144

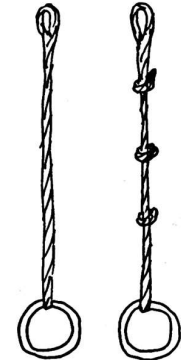

Rope Foot Swing  
plain \$96  
Knotted \$108

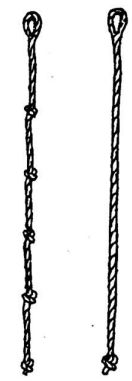

2 m ropes plain \$54  
Knotted \$96

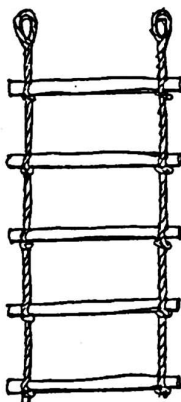

Rope and Dowel  
Ladder \$192

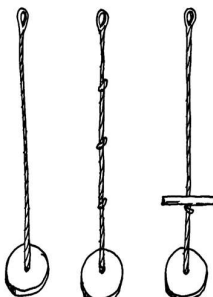

Wooden Platter  
Swing  
Plain \$156  
Knotted \$168  
handle \$168

**Please Note: We also offer a repair and rope replacement service.**  
Prices exclude GST and freight.

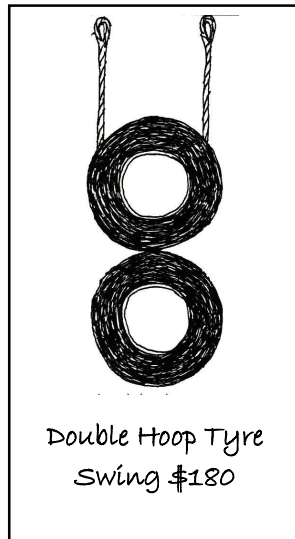
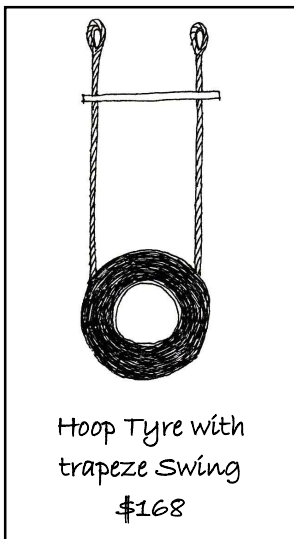
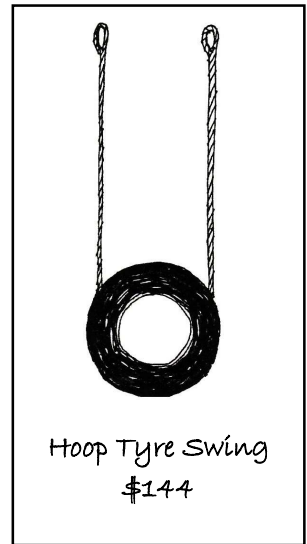
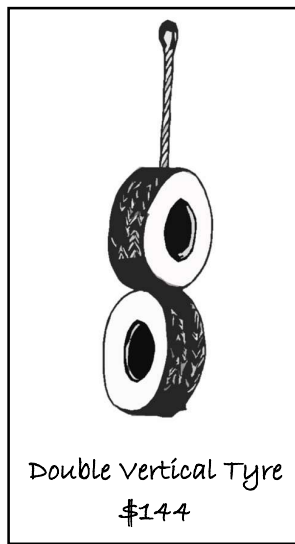
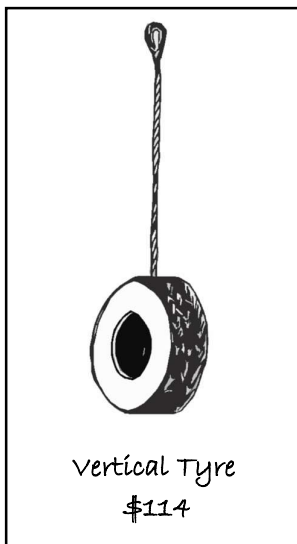
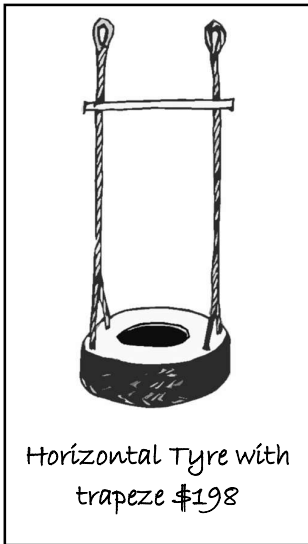
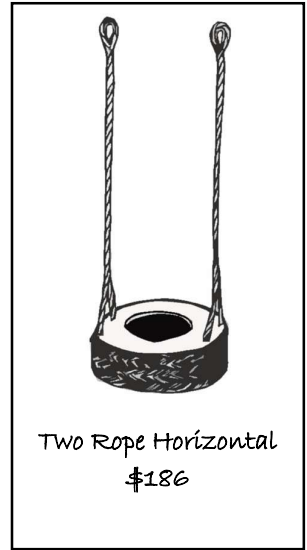
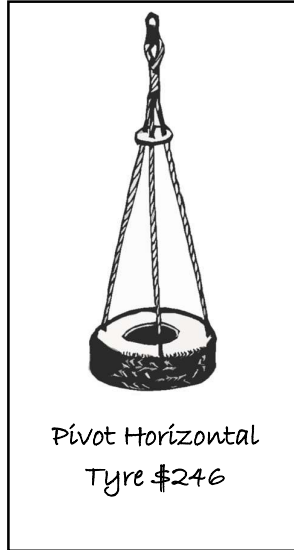
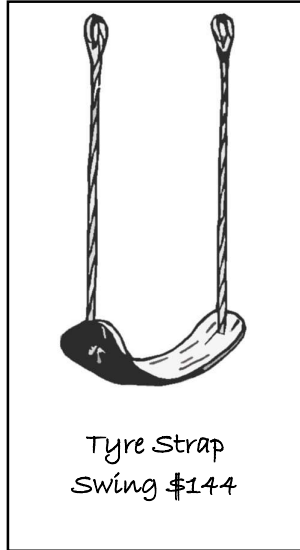

Please Note: We also offer a repair and rope replacement service.  
Prices exclude GST and freight.

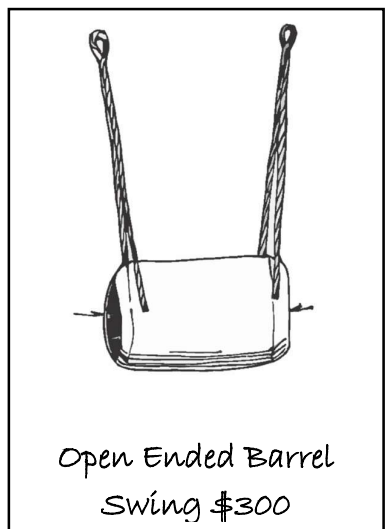
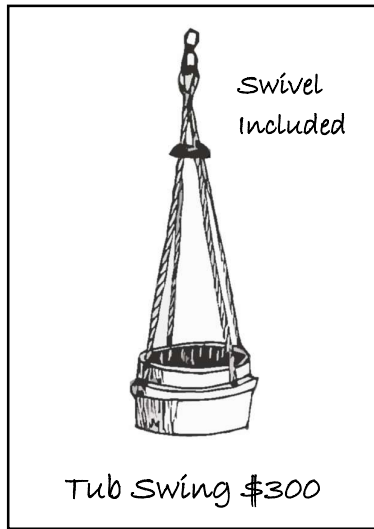
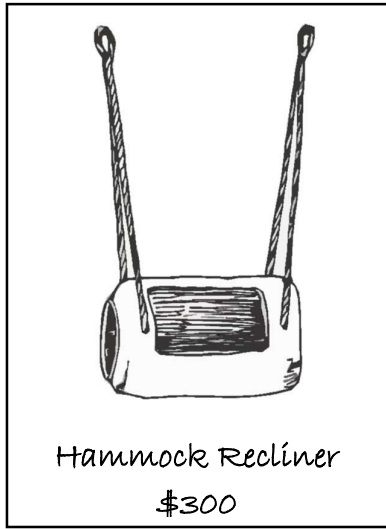
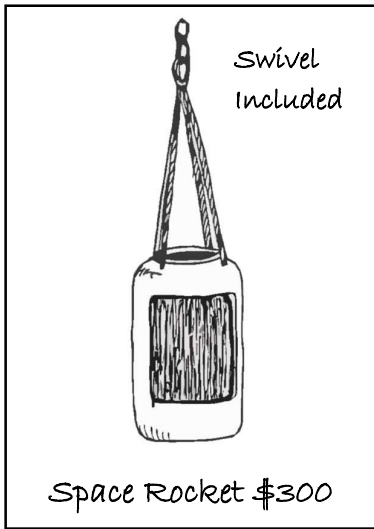
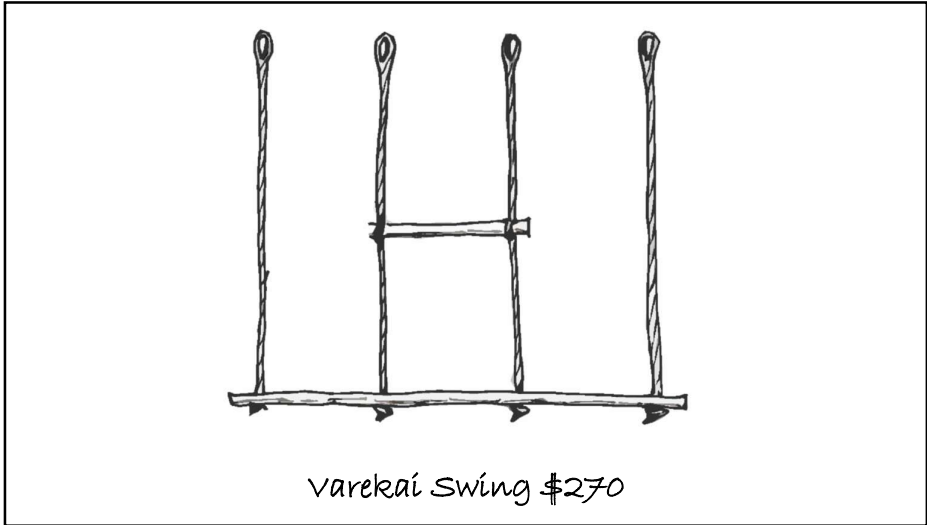

**Please Note: We also offer a repair and rope replacement service.**  
Prices exclude GST and freight.

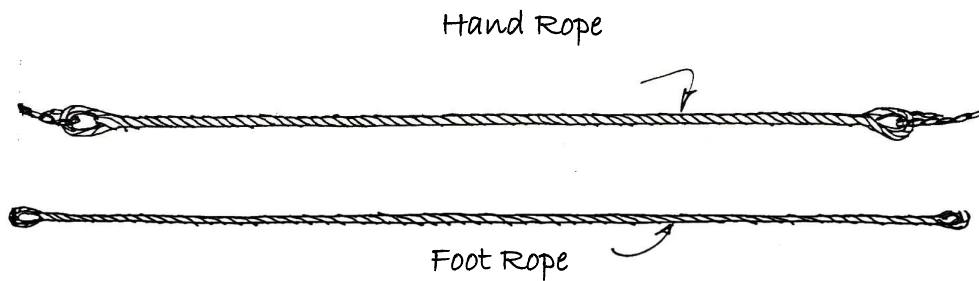

Note accurate pole face to pole face measurements are important. Fixing is by chain to eyebolt or through the poles.

Balancing Rope set an average price including all fittings \$234

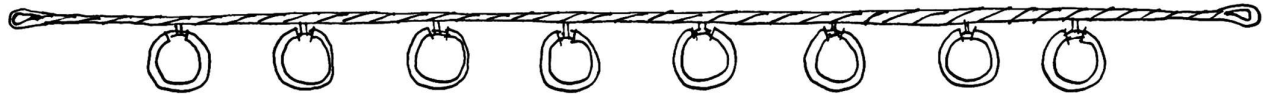

Monkey rings average price including all fittings and foot rope \$318

### Re-Roping Service

If your swings are becoming frayed or worn do not throw the swing away, send us an email with a photo and we will access them for repair.

Price by request to [swingsandthingsnz@gmail.com](mailto:swingsandthingsnz@gmail.com)

Send re-rope swings to

Swings and Things, Unit 7, 13 Beatrice Tinsley Dr, Albany, Auckland. Attention Rob 021 934 062,

Make sure you include your swing frame measurement and of course put a note on where the swing is from!





Swing frame showing changeable equipment

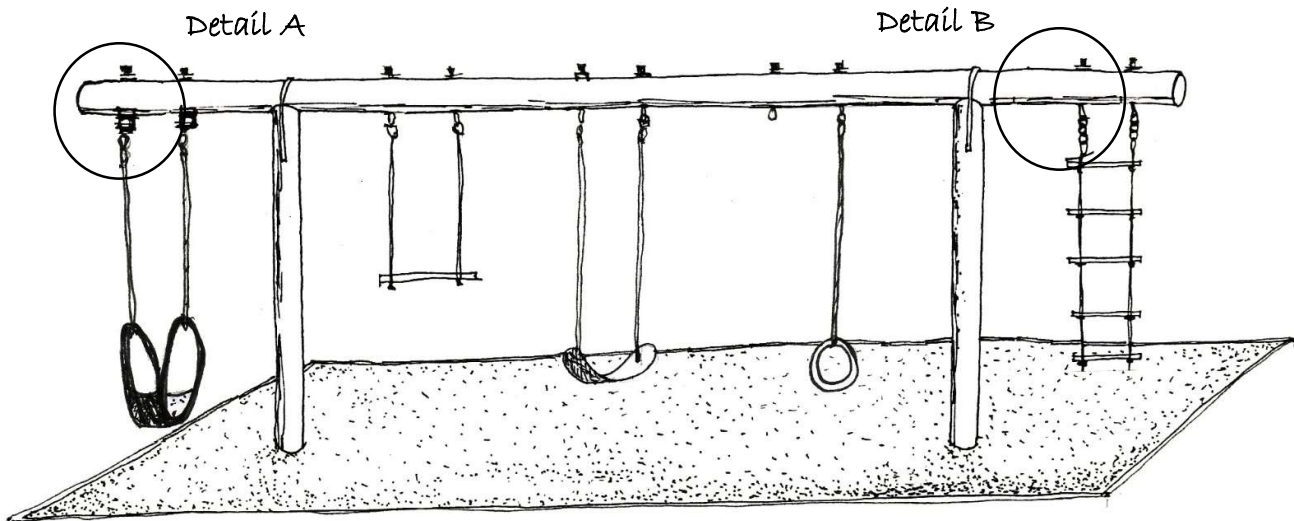

### Detail A Pendulum Eyebolt

This configuration uses the pendulum eyebolt and eliminates wear on the carabine clip and stops squeaks. This is recommended where swings have heavy use.

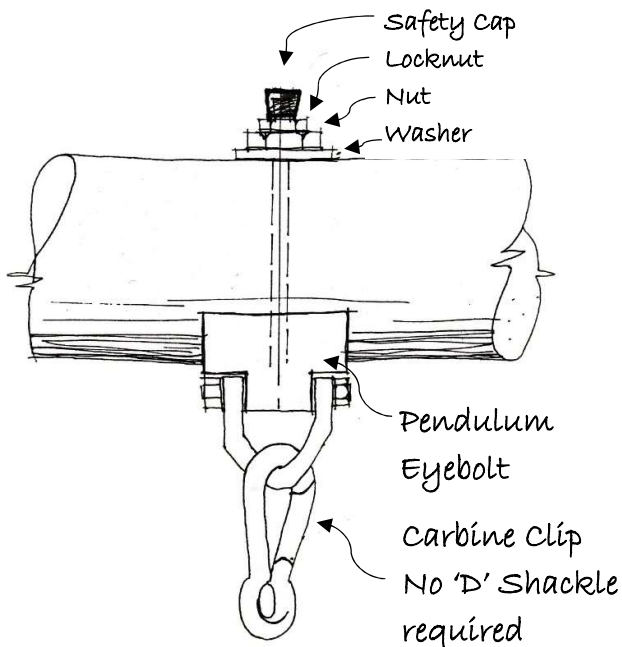

### Detail B Eyebolt

This configuration uses a 'D' shackle to reduce the wear on the carabine clip. The 'D' shackle needs to be permanently left on the eyebolt.

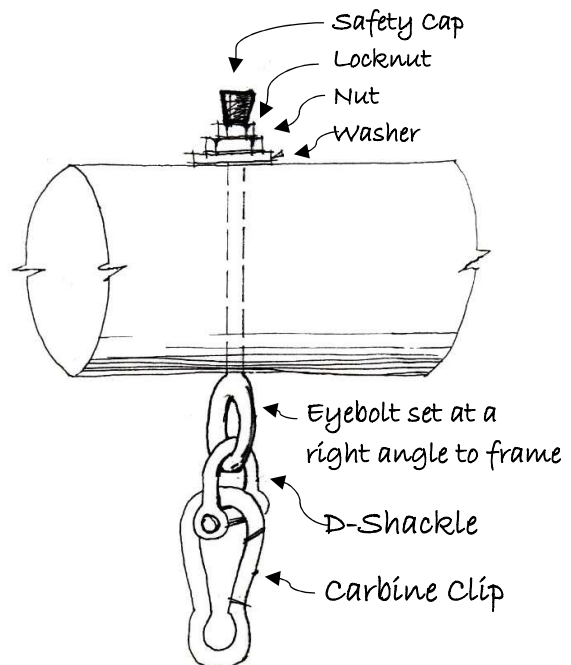

**Please Note: We also offer a repair and rope replacement service.**  
Prices exclude GST and freight.



Lock Nut

Length

Eyebolts  
 150mm \$16  
 200mm \$17  
 250mm \$18  
 300mm \$19

Safety cap required

Pendulum Eyebolt  
 \$78

Removes squeaks and stops wear and tear

10mm Carbine  
 length 100mm \$12.50

Large 12mm Carbine  
 length 120mm \$16.50

10mm galvanised  
 'D' Shackle \$5.50

Swivel Stainless Steel  
 \$40

**Note:** Please state pole diameter or timber thickness when ordering eyebolts. Price range according to size.  
 Carbine clips are used when you need to change swings frequently.

Cleat and screws \$18.50

Galvanized Chain  
 \$14.50 per metre

12mm Rope  
 \$7 per metre

Rope Thimble  
 \$5

Galvanised Washer  
 \$3.50

Safety cap for Eyebolts \$5

**Please Note: We also offer a repair and rope replacement service.**  
 Prices exclude GST and freight.



How to order!

Ask for a Quote or Email your order through to [swingsandthingsnz@gmail.com](mailto:swingsandthingsnz@gmail.com)

Once you have selected the swing you would like to purchase, we need some measurements from you. Please measure the height of your swing frame i.e. from the bottom edge of the eyebolt to the ground. We will work out the swing height based on the safety standards and your supplied swing frame measurement.

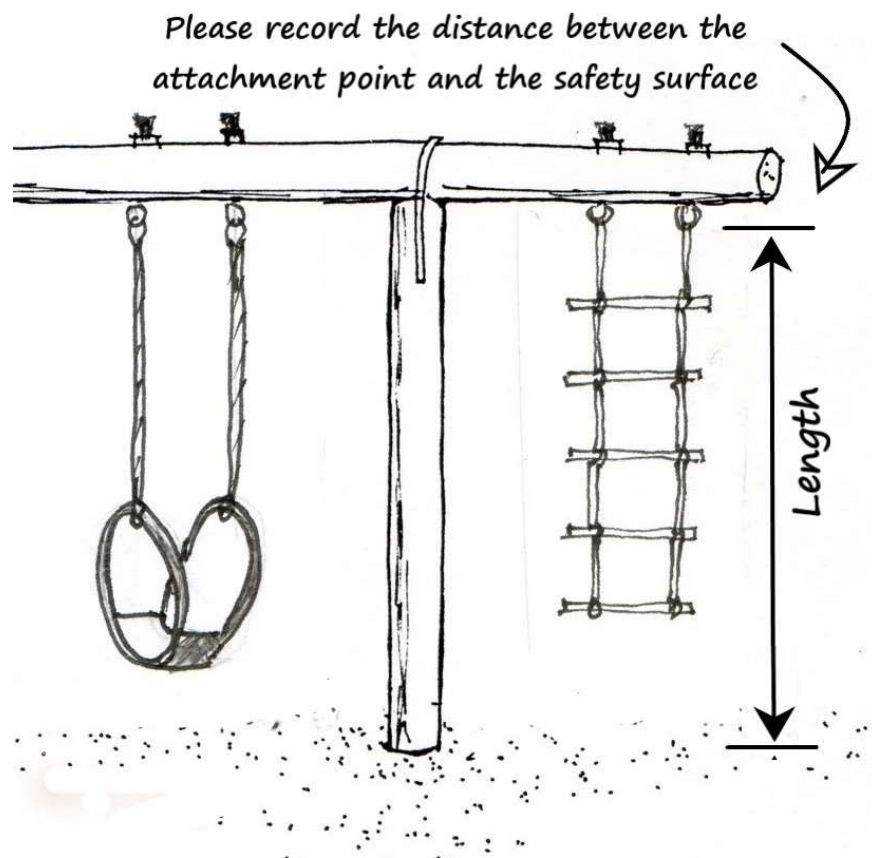

As swings are made by hand and to order, delivery times can be two to four weeks, please let us know if your need is urgent.

Note: Pricing does not include freight. If required please ask for a separate price for freight as large items can be quite expensive to ship around the country.

If you have any questions, please call 021 128 0521 and we will be pleased to help.

**Please Note: We also offer a repair and rope replacement service.**  
Prices exclude GST and freight.