



1 1/2-5
years

Ice Cream Cozy Truck™

ASSEMBLY INSTRUCTIONS

#657856M8

Adult assembly required. Approx. assembly time: 50 min.



Look for video of assembly at
littletikes.com/videoinstructions

Thank you for choosing the Little Tikes® Ice Cream Cozy Truck™.

We strive to provide a durable, easy-to-assemble toy that's made to last, giving your child years of imaginative, engaging fun!

Really important information you should know!

- Read through all the instructions first.
- Clear a flat surface to lay out all the materials so everything is close at hand.
- You will need a Phillips head screwdriver (power driver, recommended, not included) hammer and safety glasses (not included) to assemble the Ice Cream Cozy Truck™.
 - When installing screws, be sure screws are tightened snugly, but do NOT OVERTIGHTEN.
- Be sure to locate your decals and set aside. Decals are easier to apply when the part is laying flat, so you may want to apply the decals before assembly.
- The parts are listed below - each part is identified with a letter in RED for easy reference.
- Illustrations are for reference only. Styles may vary from actual contents.
- **If you have any questions, we're here to help. Give our customer service team a call at 1-800- 321-0183.**

WARNINGS!

• **Adult Assembly Required**

- Keep these instructions for future reference.
- Prior to assembly, this package contains small parts: hardware which is a choking hazard and may contain sharp edges and sharp points. Keep away from children until assembled.
- Ride-on toys should not be used near swimming pools, on or near steps, hills, roadways, or inclines.
- Shoes must be worn at all times.
- Only one rider at a time.
- Maximum weight limit: 50 lbs. (23 Kg)
- This product is intended for use by children ages over 1 1/2 - 5 years.
- Adult supervision required. Do not leave children unattended.
- This product is intended for outdoor domestic family use only.
- Protect your eyes. Always wear safety glasses when using a hammer.
- When temperatures fall below 0°F/-18°C, outdoor use of this product is not recommended. In extreme cold, plastic materials lose resilience and may become brittle and crack upon impact. Store product in a warmer, protected place.

DISPOSAL

Disassemble and dispose of equipment in such a manner that no hazardous conditions such as, but not limited to, small parts and sharp edges exist at the time equipment is discarded.

BATTERY SAFETY INFORMATION:

- Keep these instructions for future reference.
- Install 3 "AAA" alkaline batteries (not included).
- The voltage of a fully-charged, rechargeable battery is often lower than that of a fresh alkaline battery. Therefore, it is recommended that alkaline batteries be used instead of rechargeable batteries for best performance and longer play time.
- Install batteries with the correct polarity (+ and -).
- To avoid battery leakage:
 1. Follow the toy and battery manufacturer's installation instructions.
 2. Do not mix old and new batteries.
 3. Do not mix standard (carbon-zinc), alkaline or rechargeable batteries. Do not mix different brands of batteries. Only batteries of the same or equivalent type as recommended are to be used.
 4. When toy is not used for an extended period of time, remove batteries to prevent possible leakage and damage to the unit.
 5. Remove dead or exhausted batteries from product.
 6. Dispose of dead batteries properly; do not bury. Do not dispose of batteries in fire as they may leak or explode.
- Make sure cover is properly installed on unit at all times.
- Do not attempt to recharge non-rechargeable batteries.
- Rechargeable batteries are to be removed from the toy before recharging.

- Charging of rechargeable batteries should be done only by an adult.
 - The supply terminals are not to be short circuited.
- NOTE: If the unit stops working or doesn't work as it should, remove the batteries for a few minutes and then re-insert them. If there is still a problem, install new batteries.

FCC COMPLIANCE

NOTE: This equipment has been tested and found to comply with the limits for a Class B digital device, pursuant to Part 15 of the FCC Rules. These limits are designed to provide reasonable protection against harmful interference in a residential installation. This equipment generates, uses and can radiate radio frequency energy and, if not installed and used in accordance with the instructions, may cause harmful interference to radio communications. However, there is no guarantee that interference will not occur in a particular installation. If this equipment does cause harmful interference to radio or television reception, which can be determined by turning the equipment off and on, the user is encouraged to try to correct the interference by one or more of the following measures:

- Reorient or relocate the receiving antenna.
- Increase the separation between the equipment and receiver.
- Connect the equipment into an outlet on a circuit different from that to which the receiver is connected.
- Consult the dealer or an experienced radio/TV technician for help.

This device complies with Part 15 of the FCC Rules. Operation is subject to the following two conditions: (1) This device may not cause harmful interference, and (2) this device must accept any interference received, including interference that may cause undesired operation.

Caution: Modifications not authorized by the manufacturer may void users authority to operate this device. This Class B digital apparatus complies with Canadian ICES-003.



'Let's care for the environment!'

The wheelie bin symbol indicates that the product must not be disposed of with other household waste. Please use designated collection points or recycling facilities when disposing of the item. Do not treat old batteries as household waste. Take them to a designated recycling facility.

© The Little Tikes Company, an MGA Entertainment company. LITTLETIKES® is a trademark of Little Tikes in the U.S. and other countries. All logos, names, characters, likenesses, images, slogans, and packaging appearance are the property of Little Tikes. Please keep this address and packaging for reference since it contains important information. Contents, including specifications and colors, may vary from photos depicted on package. Instructions included. Please remove all packaging including tags, ties & tacking stitches before giving this product to a child.

CONSUMER SERVICE:

United States:

www.littletikes.com

1-800-321-0183 Monday - Friday

The Little Tikes Company

2180 Barlow Road, Hudson, OH 44236

E-mail: service@littletikescare.com

Printed in U.S.A. D.R.©2020 The Little Tikes Company

United Kingdom:

www.littletikes.co.uk

Little Tikes, MGA Entertainment (UK) Ltd

50 Presley Way

Crownhill

Milton Keynes MK8 0ES

Bucks, UK

Tel: +0 800 521 558

E-mail: support@LittleTikesStore.co.uk

Australia

www.littletikes.com.au

Imported by MGA Entertainment

Australia Pty Ltd

Suite 2.02, 32 Delhi Road

Macquarie Park NSW 2113

1 300 059 676



LIMITED WARRANTY

The Little Tikes Company makes fun, high quality toys. We warrant to the original purchaser that this product is free of defects in materials or workmanship for one year * from the date of purchase (dated sales receipt is required for proof of purchase). At the sole election of The Little Tikes Company, the only remedies available under this warranty will be the replacement of the defective part or replacement of the product. This warranty is valid only if the product has been assembled and maintained per the instructions. This warranty does not cover abuse, accident, cosmetic issues such as fading or scratches from normal wear, or any other cause not arising from defects in material and workmanship. *The warranty period is three (3) months for daycare or commercial purchasers.

U.S.A and Canada: For warranty service or replacement part information, please visit our website at www.littletikes.com, call 1-800-321-0183 or write to: Consumer Service, The Little Tikes Company, 2180 Barlow Road, Hudson OH 44236, U.S.A. Some replacement parts may be available for purchase after warranty expires—contact us for details.

Outside U.S.A and Canada: Contact place of purchase for warranty service. This warranty gives you specific legal rights, and you may also have other rights, which vary from country/state to country/state. Some countries/states do not allow the exclusion or limitation of incidental or consequential damages, so the above limitation or exclusion may not apply to you.



A Few Things Before You Start!

BEFORE you begin assembly, make sure you have all the parts listed below.

! Some packages of hardware may have extras pieces.

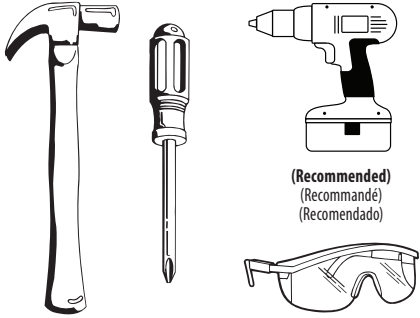
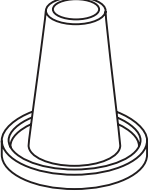
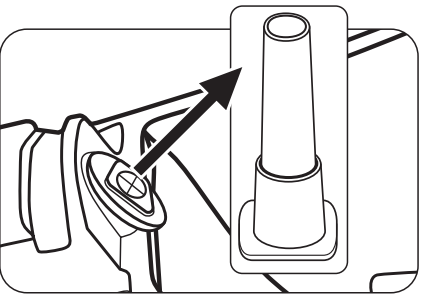
! Questions? We're here to help.
Little Tikes customer service team at 1-800- 321-0183.

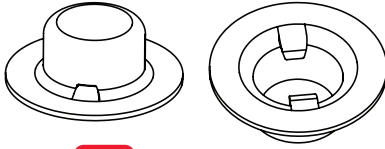
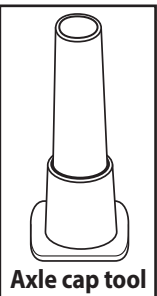
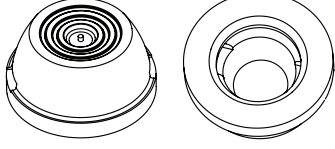
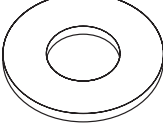
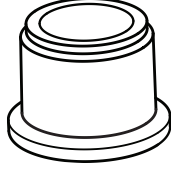
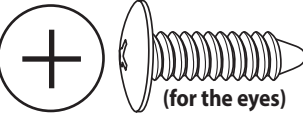
<p>Tools required (not included)</p>  <p>(Recommended) (Recommandé) (Recomendado)</p>	<p>Included in hardware pack. Discard after use.</p>  <p>Top hat tool</p> <p>Tool color may vary.</p>	 <p>Remove axle cap tool and use for assembly. Discard after use.</p>
---	---	--

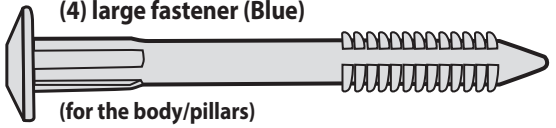
<p>Hardware Guide</p>  <p>Top hat tool</p>  <p>AA Top hat (4)</p>	 <p>Axle cap tool</p>  <p>BB Axle Cap (2)</p>	 <p>CC Washer (6)</p>  <p>DD Bushing (6)</p>
<p style="text-align: center;">Shown actual size</p> <div style="display: flex; justify-content: space-between;"> <div data-bbox="138 1564 422 1984"> <p>(8) 3/4" (1.9 cm) (for large ice cream cone)</p> <p>(9) 1" (2.54 cm) (3 - for rear tray) (4 - for ice cream cone to roof) (2 - for sound module to roof)</p> <p>(4) 1/2" (1.27 cm) (2 - for door latch) (4 - for the eyes)</p> </div> <div data-bbox="552 1638 860 1963"> <p>(2) short plastic fastener</p>  <p>(for the eyes)</p> <p>(6) Cap covers</p>  </div> <div data-bbox="966 1606 1518 1932"> <p>(2) large fastener (Red) (for the roof/pillars)</p>  <p>(4) large fastener (Blue) (for the body/pillars)</p>  </div> </div>		

A Body (1)

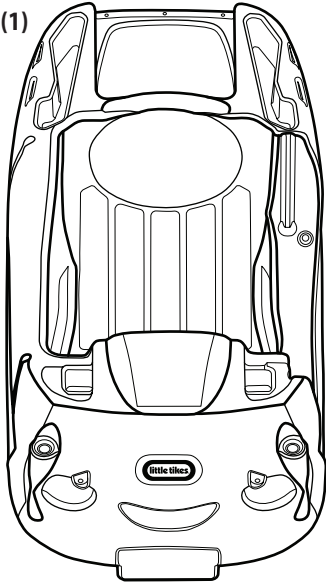

D Roof (1)

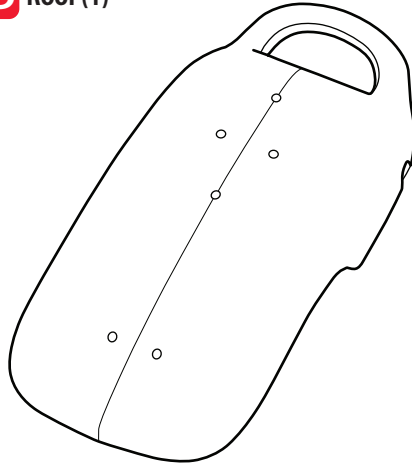

Roof Pillars - FRONT

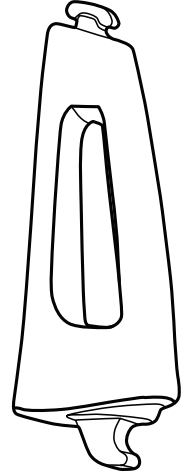
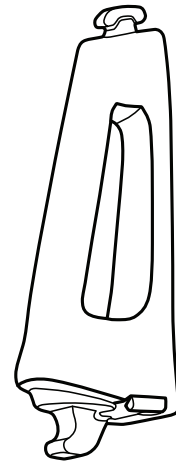

E1 Roof pillars - front right (1)

E2 Roof pillars - front left (1)

B Door (1)

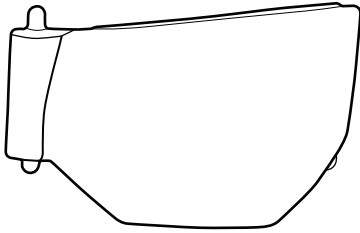

C Door latch (1)

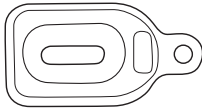

G Eye base (2)

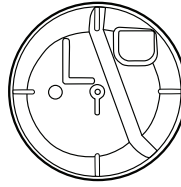
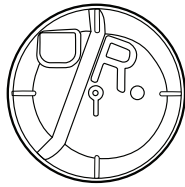

H Eye cover (2)

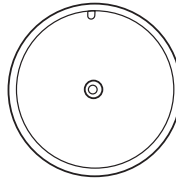
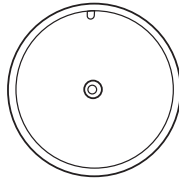

Roof Pillars - REAR

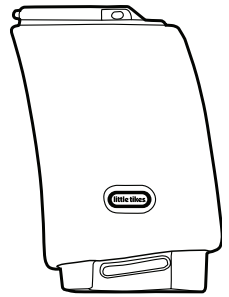
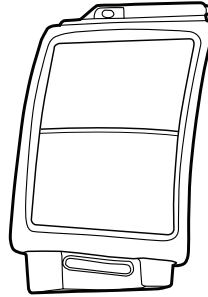

F1 Roof pillars - rear right (1)

F2 Roof pillars - rear left (1)

I Cooler lid (1)

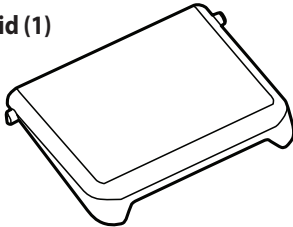

J Rear tray (1)

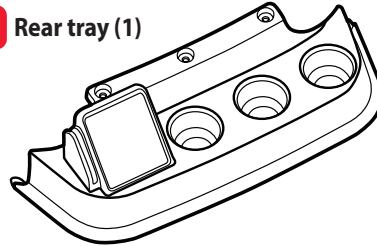

K Tail Lights (2)

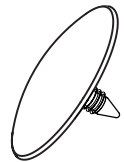

M Wheels (4)

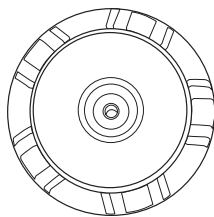
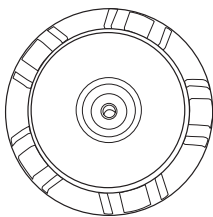
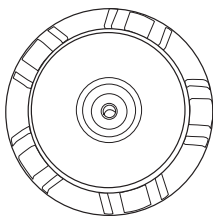
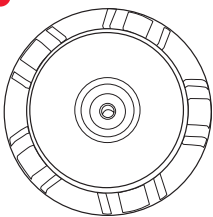

O Center caps (4)

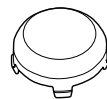
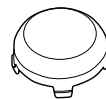
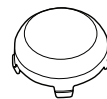
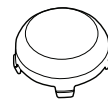

N Hubcaps (4)

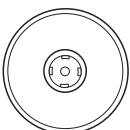
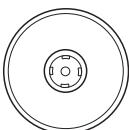
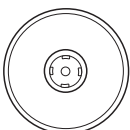
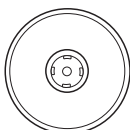

P Rear axle (1)

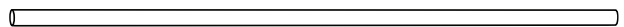

Front Wheel Axles

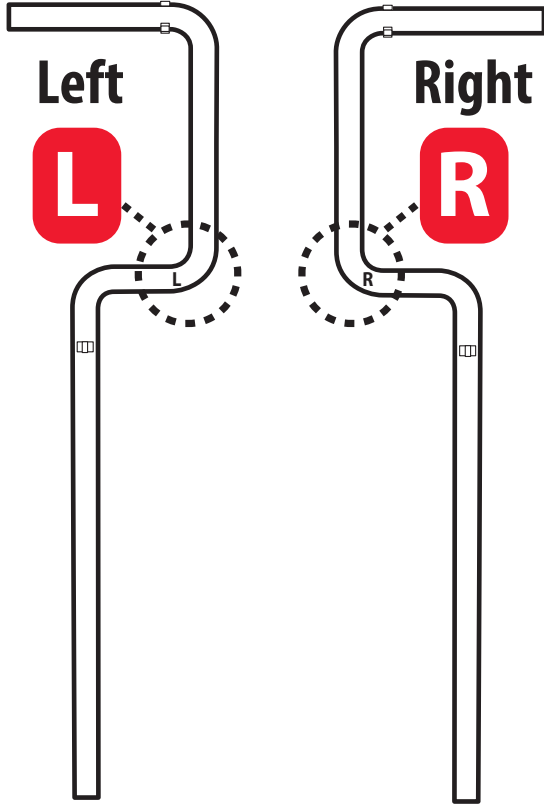

Q1 Horn collar (1)

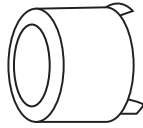

Q2 Horn button (1)

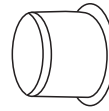

Q3 Horn bellows (1)

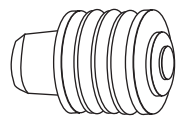

S Steering clip (1)

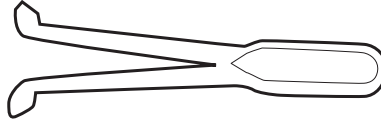

U Steering Wheel (1)

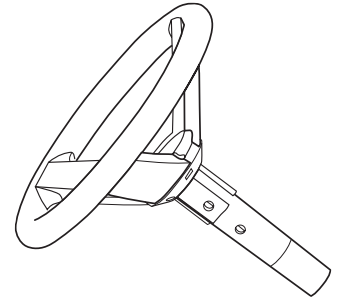

T Steering O-ring (1)

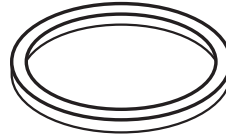

V Floorboard buttons (2)

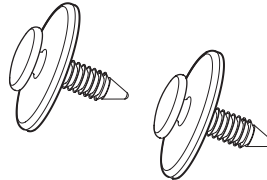

W Floorboard (1)

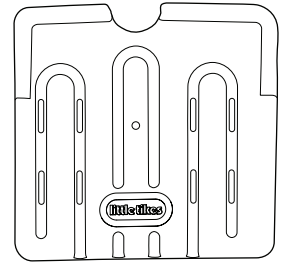

Roof Ice Cream Cone

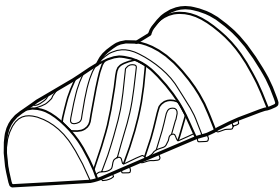

X1 Ice cream cone top (1)

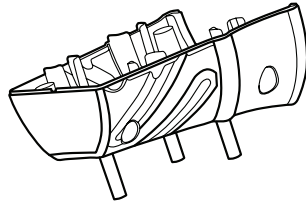

X2 Ice cream cone bottom (1)

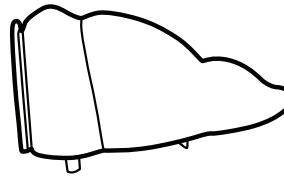

Y1 Ice cream top (1)

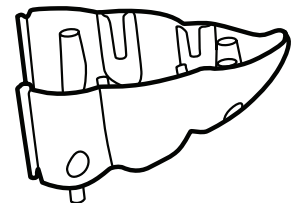

Y2 Ice cream bottom (1)

Z Sound module (1)

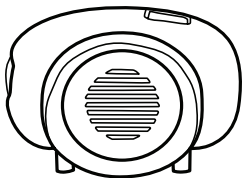

Accessories

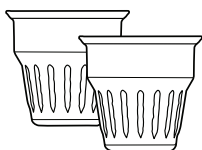

Cones (2)



Ice cream tops (2)

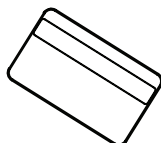

Credit card (1)



(2) Decal sheet is located in the hardware pack.

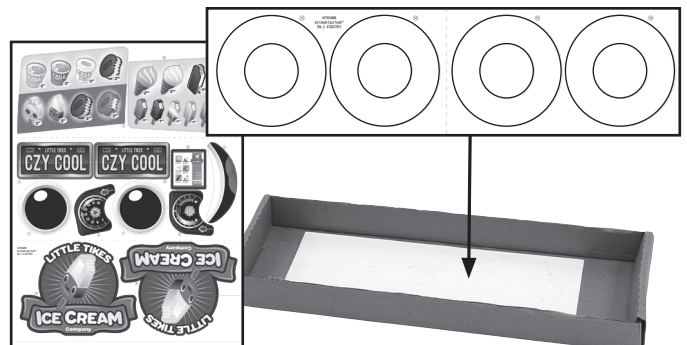

1 Ready...let's get started...pop in the tail lights!

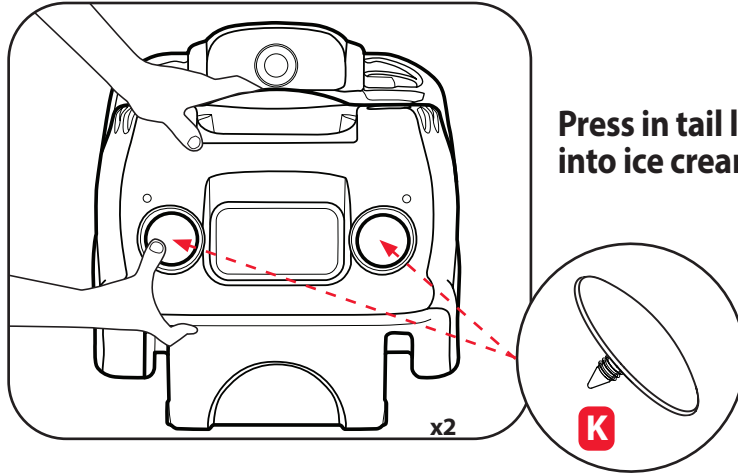

Press in tail lights (part K) into ice cream truck body

2 Put the horn together

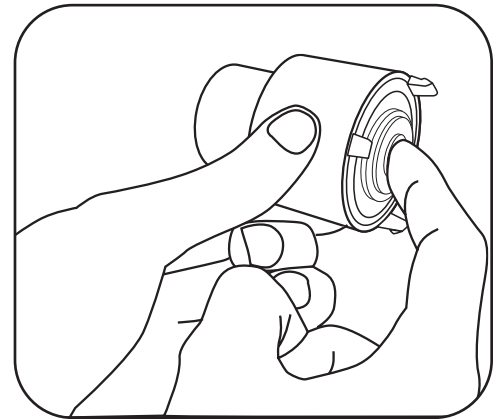

Insert horn button (part Q2) and bellows (part Q3) into horn collar (part Q1)

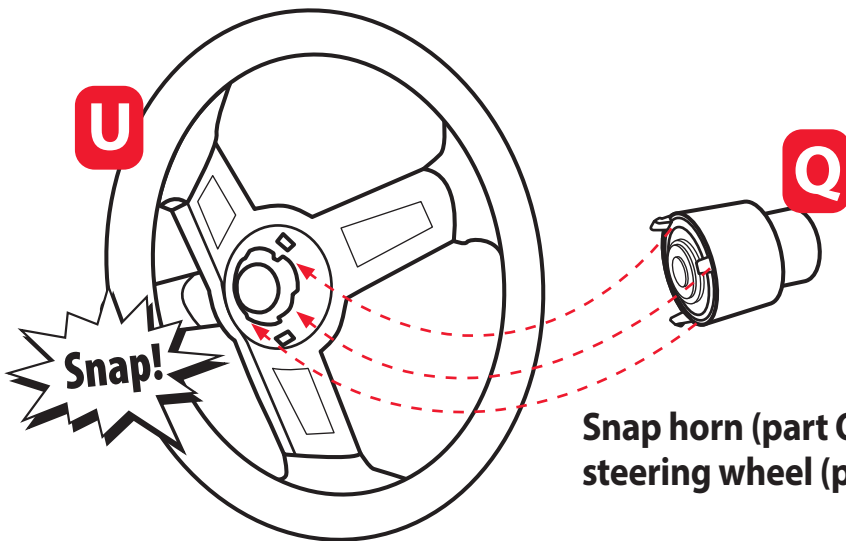

Snap horn (part Q) into center of steering wheel (part U)

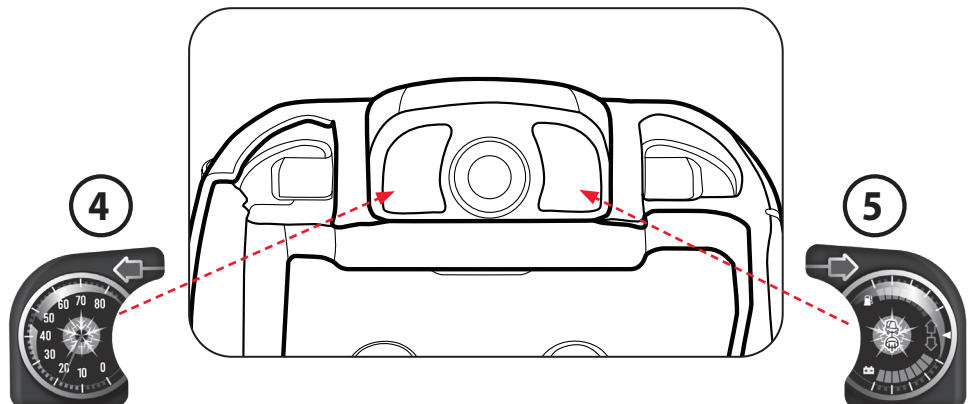

Before installing steering wheel, apply decals 4 & 5 to dashboard.

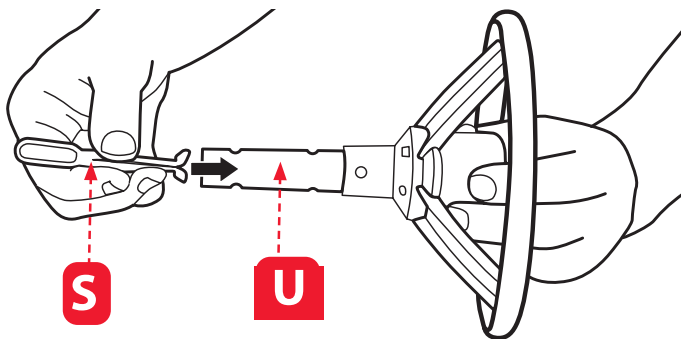

3 Steering wheel...in a Click!

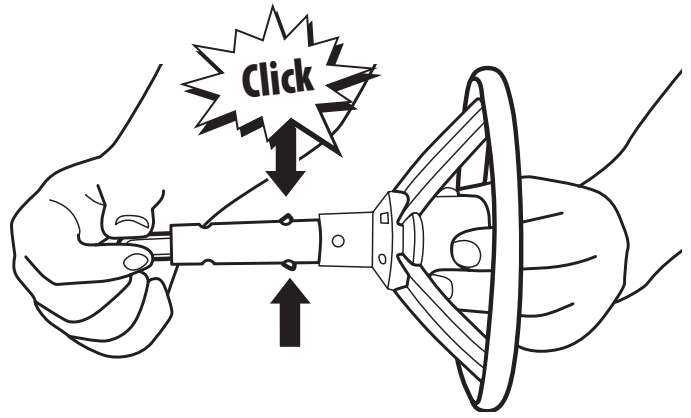

1 Squeeze steering clip (part S) into steering wheel (part U)



2 Steering clip should snap into MIDDLE hole on each side of the steering column.

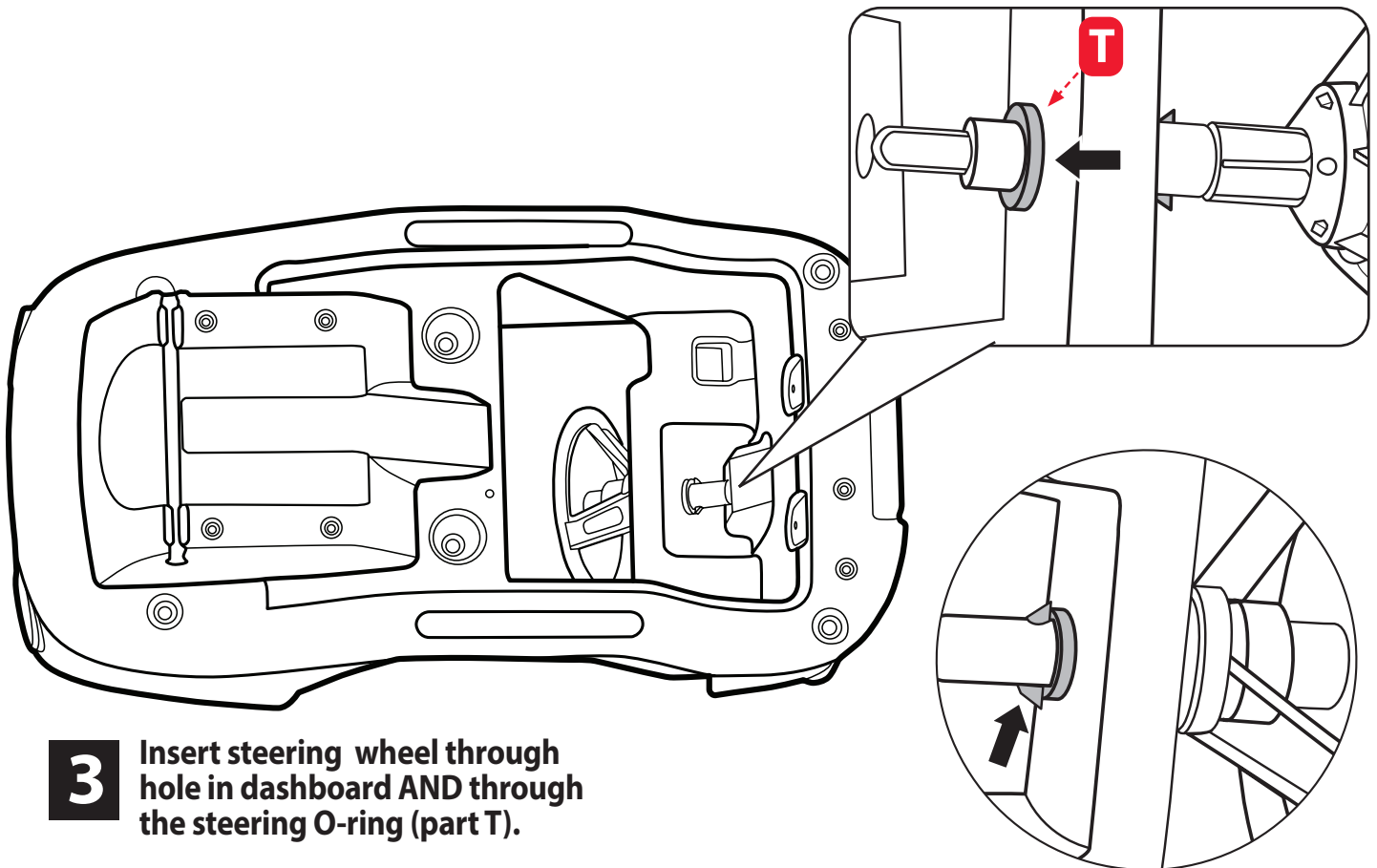

3 Insert steering wheel through hole in dashboard AND through the steering O-ring (part T).

4 Make sure the steering clip snaps past the O-ring.



If your steering wheel is loose or not staying in place; check to be sure the steering clip has completely snapped past the O-ring.

4 Floorboard needs buttons!

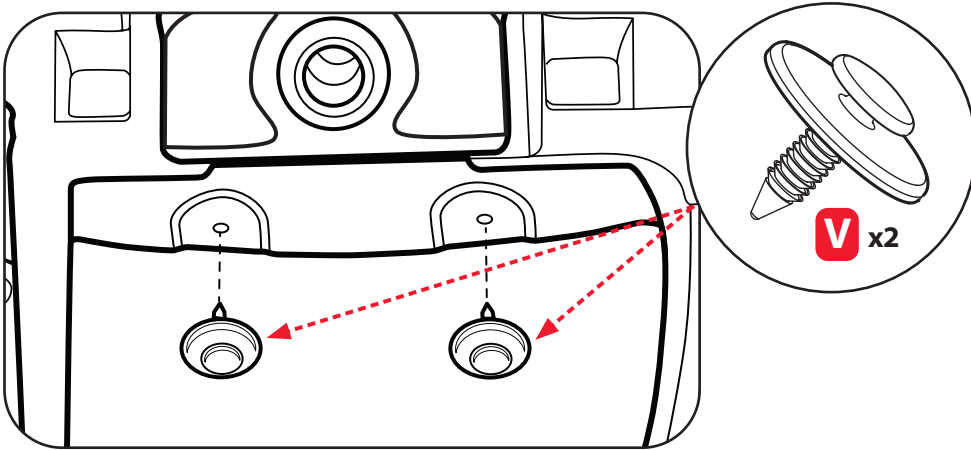

Insert (2) floorboard buttons (part V).

5 Ice Cream! Ice Cream!

1

Insert the ice cream bottom (part Y2) into the groove on the ice cream cone bottom (part X2).

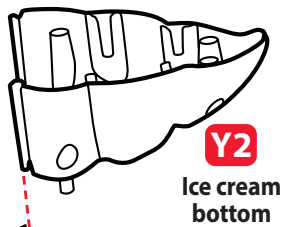

X2
Ice cream cone bottom

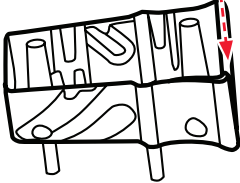

2

Attach the ice cream top (part Y1) to the assembled ice cream.



Y1
Ice cream top

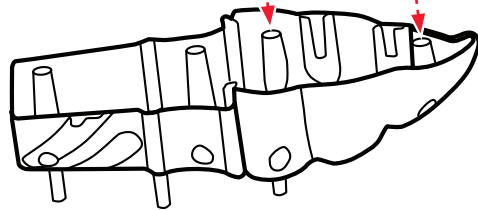

X1

Ice cream cone top

3

Fit the ice cream cone top (part X1) to the assembled ice cream.

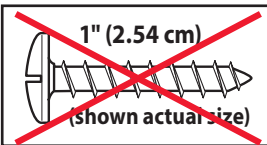
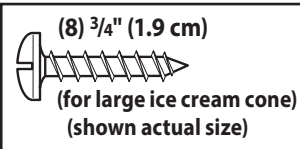
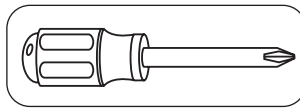
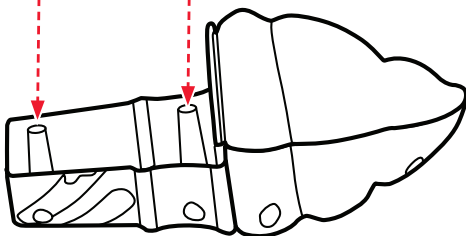
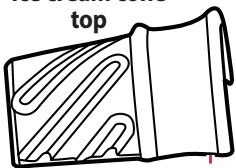

4

Secure using (8) $\frac{3}{4}$ " (1.9cm) screws.

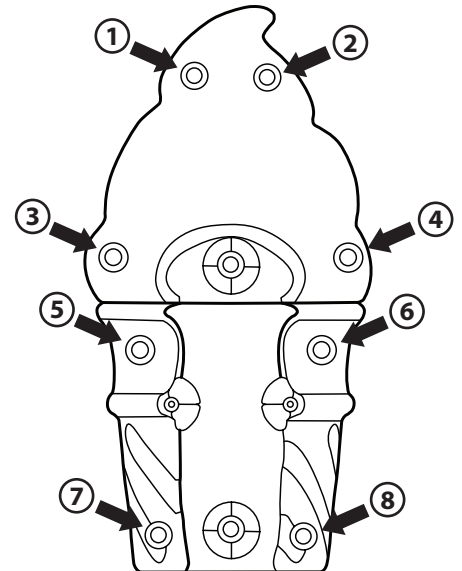

6 Add the tray...

1 Align notches on tray (part J) and insert into the rear of the ice cream body.

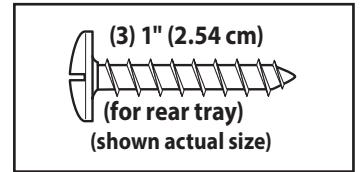
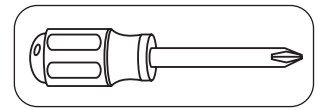
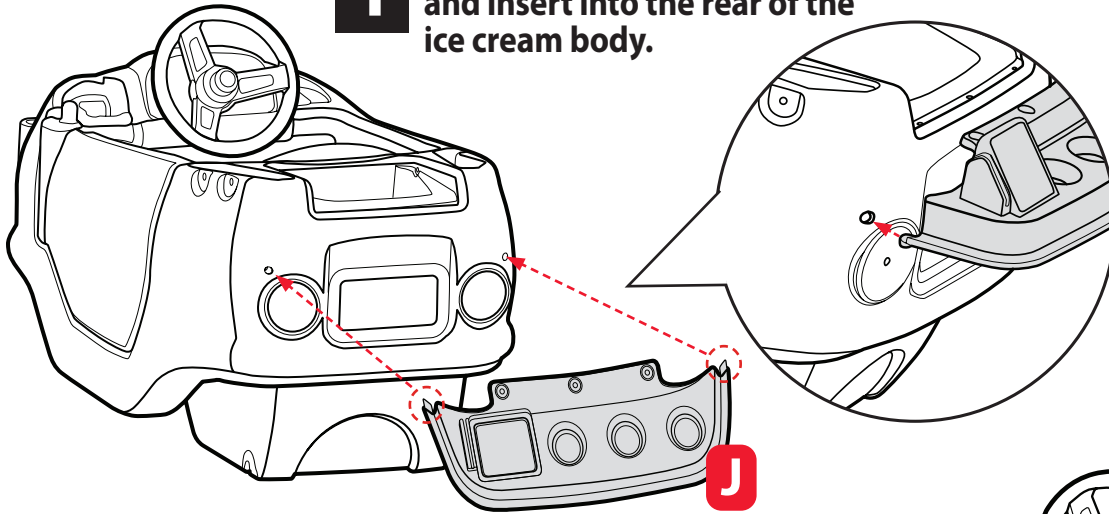

2 Swing tray up into position.

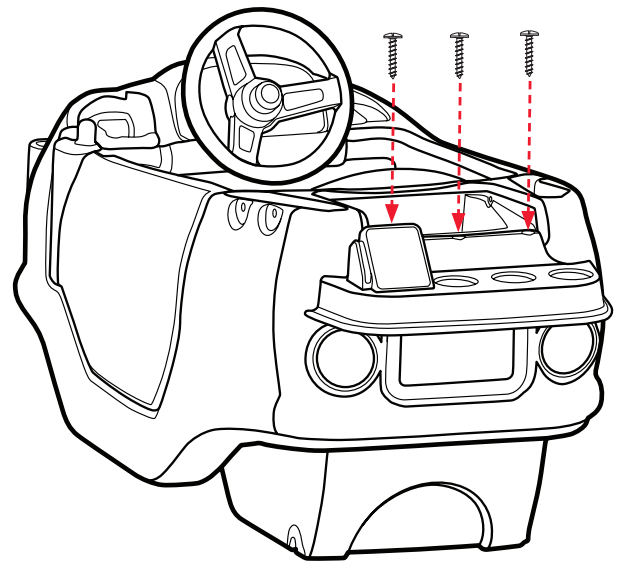
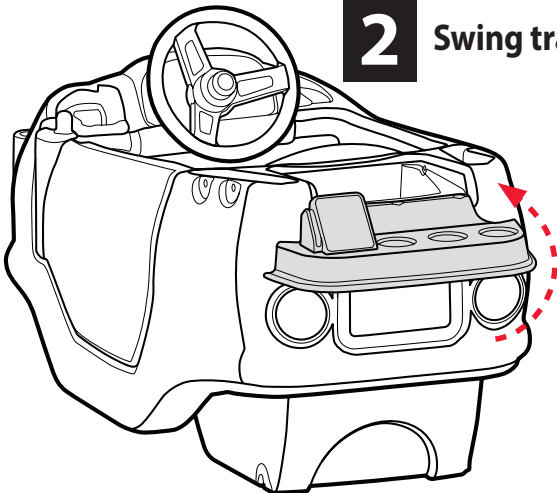

3 Secure rear tray using (3) 1" (2.54cm) screws.

7 And now the cooler lid...

Attach cooler lid (part I) to body of truck.

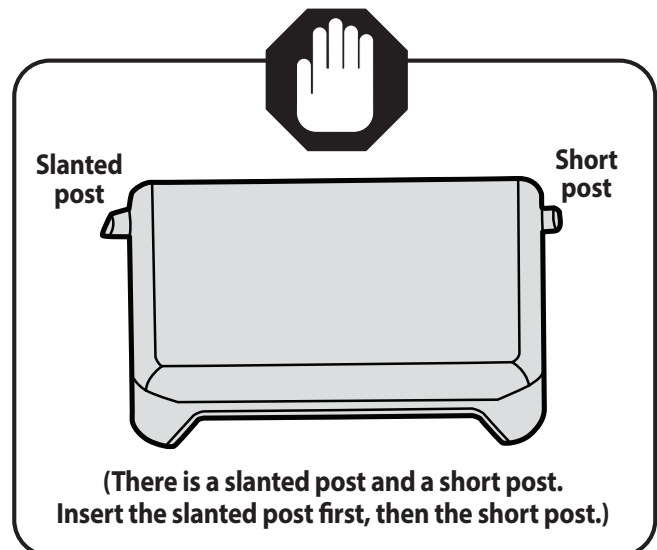
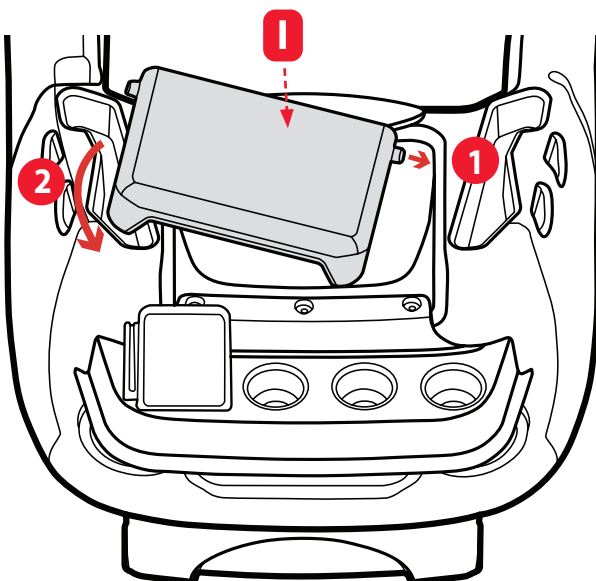

8 Batteries before assembly!

Tool required (not included)

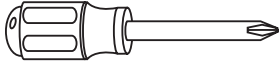

Battery installation **MUST** be completed by an adult:

1. Using a Phillips screwdriver (not included) remove the screws and battery compartment cover (1) located on the sound module (Z).
2. Install three (3) fresh AAA alkaline batteries (not included), making sure the (+) and (-) ends face the proper direction as indicated inside the battery compartment.
3. Replace the compartment cover and tighten the screws.

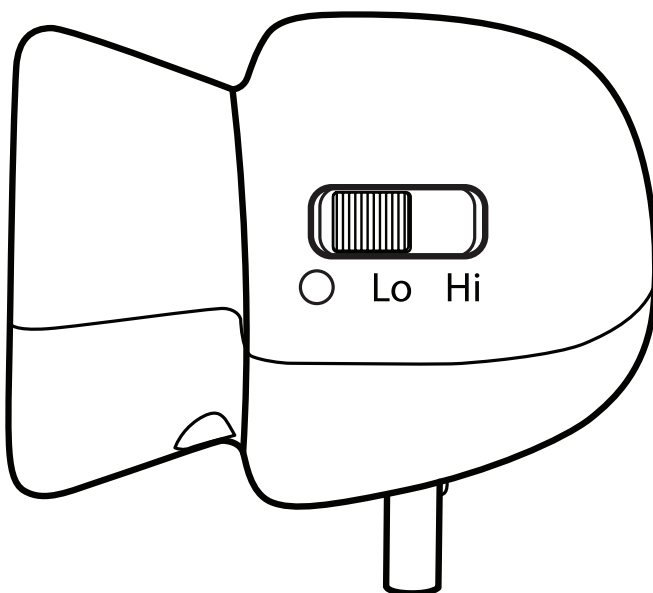
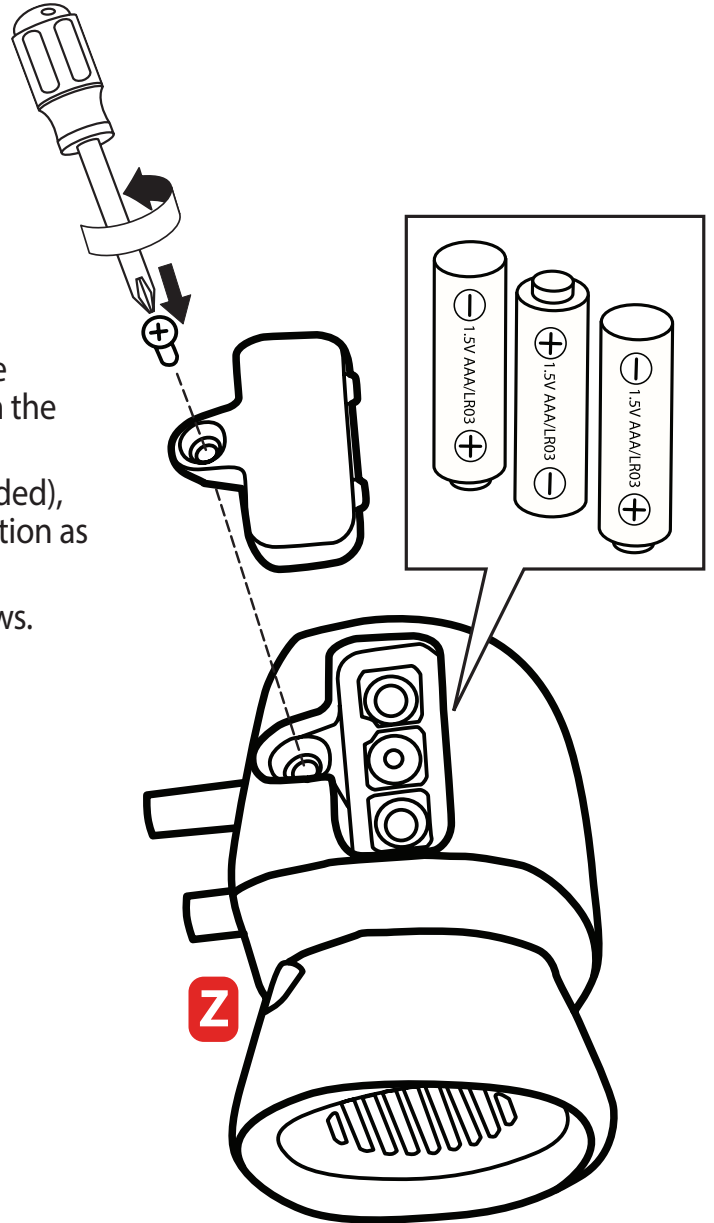

- Press the ON button to start the ice cream song. The song is motion activated. So when there is no movement, the song will shut off.
- Switch OFF. Turn on to start again.

9 Let's put it all together!

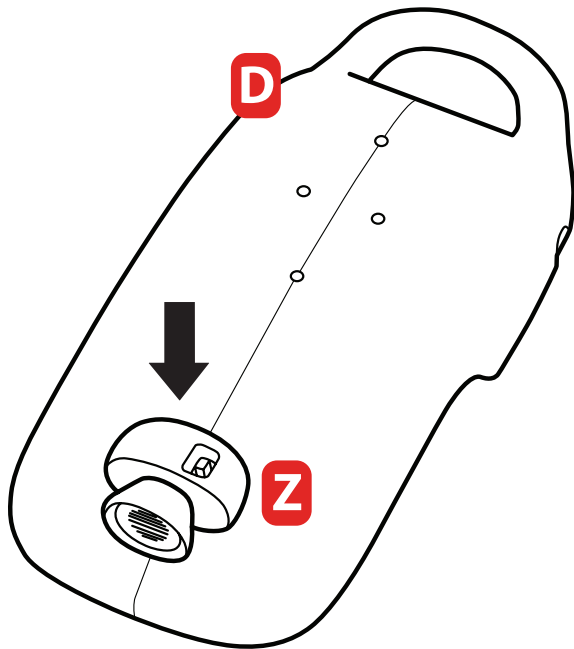
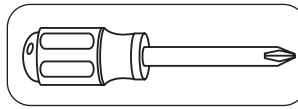

Insert sound module (part Z) onto the **FRONT** of the roof (part D) (speaker should be facing forward).

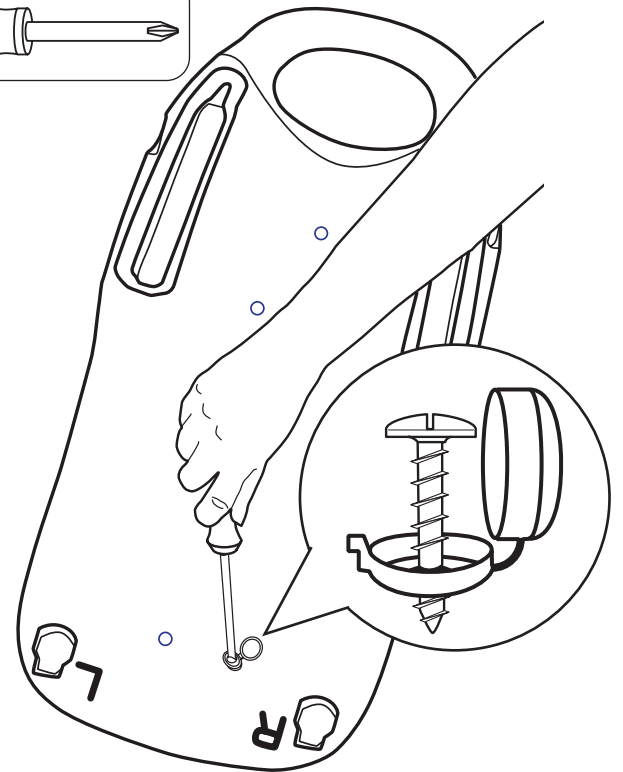
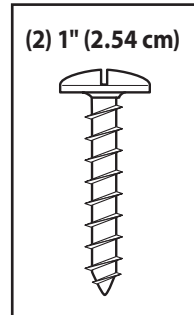

Turn roof over, thread (2) 1" (2.54cm) screws through (2) cap covers and install them into the sound module. Snap close cap cover over the screw head.

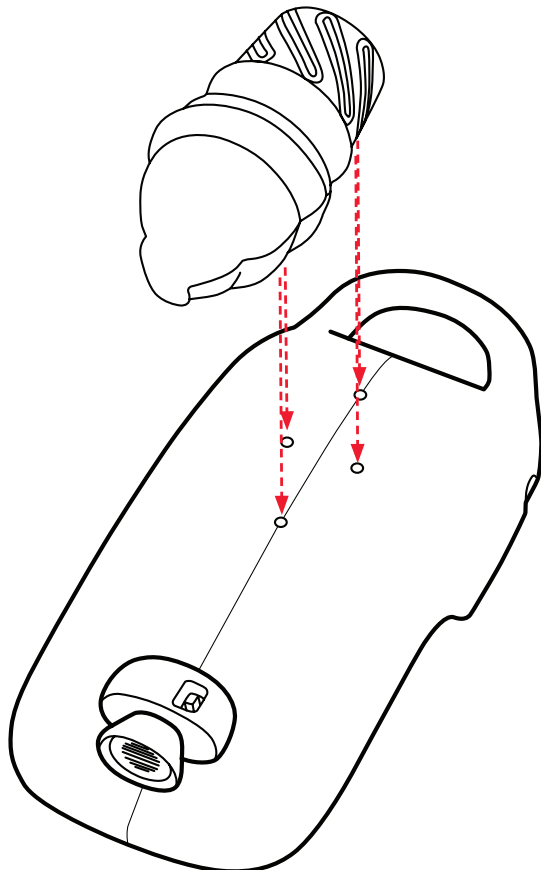

Insert assembled ice cream cone onto the **REAR** of the roof.

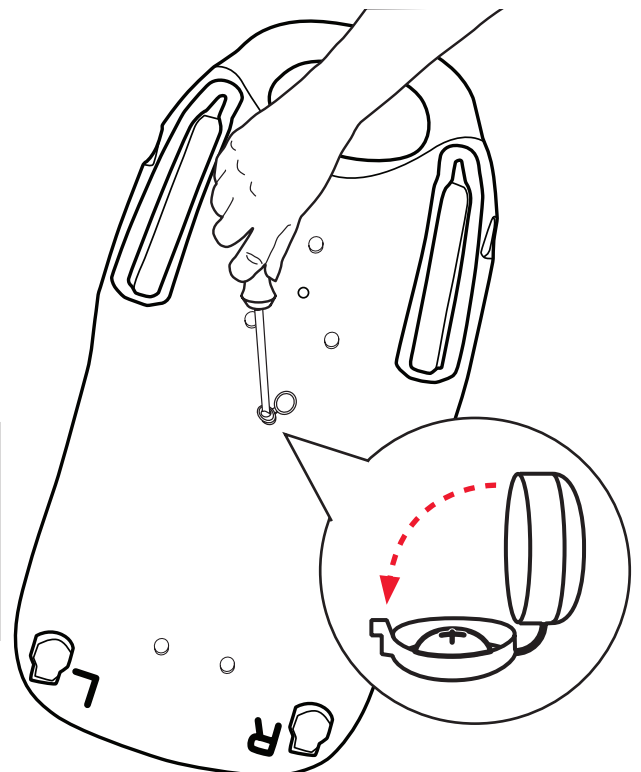
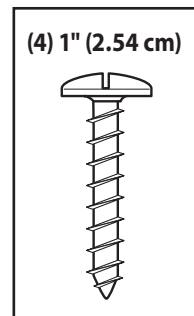

Thread (4) 1" (2.54cm) screws through (4) cap covers and install them into the ice cream cone. Snap close cap cover over the screw head.

10 Choose your lock!

First, install door latch (part C) into door (part B) Attach using (1) 1/2" (1.27 cm) screw.

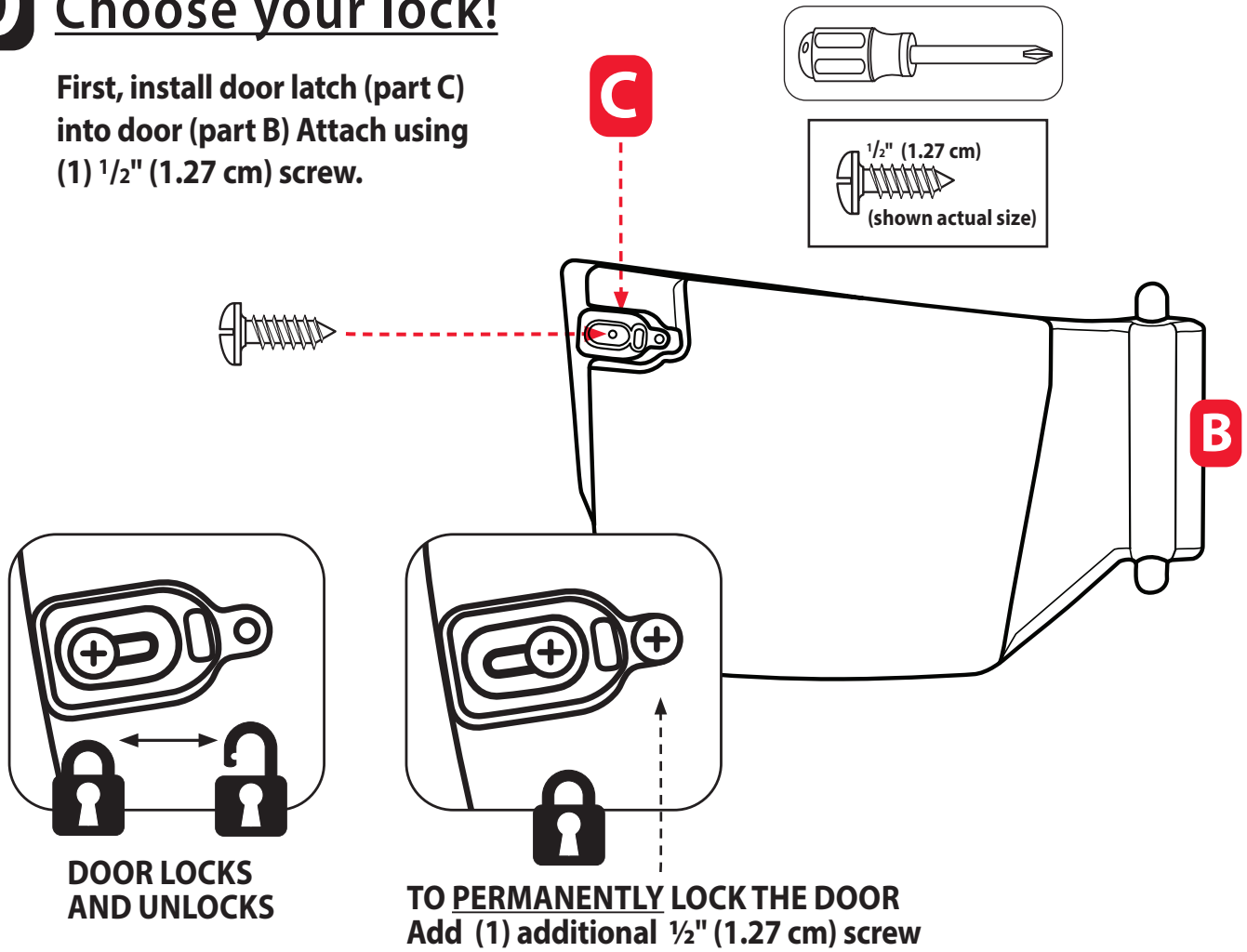

11 Add a door...

Insert door (part B) into body (part A).

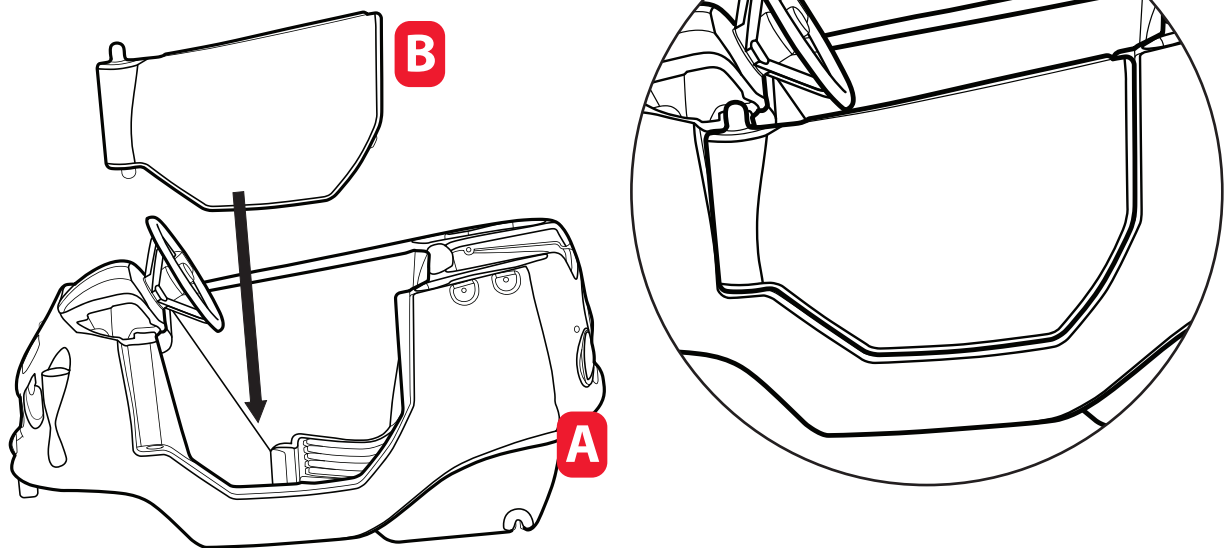

12 Roof and pillars match up!



BEFORE YOU START:
match roof supports
marked "L & R" to the
correct side of roof
also marked "L & R".

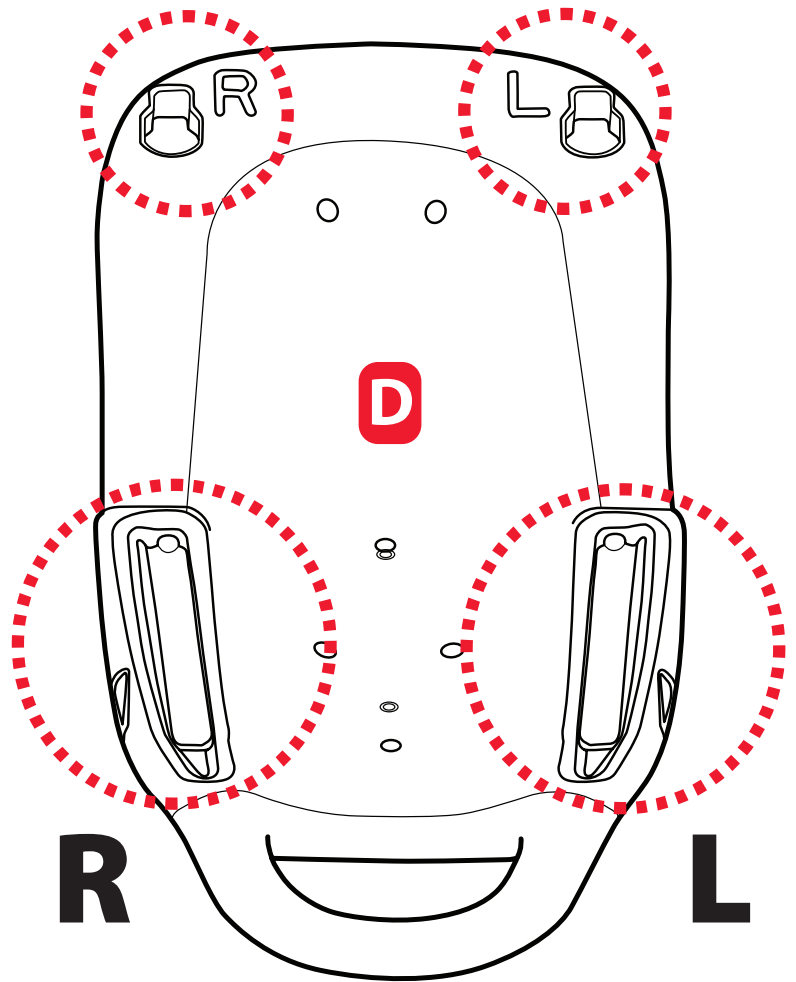

Roof Pillars - FRONT

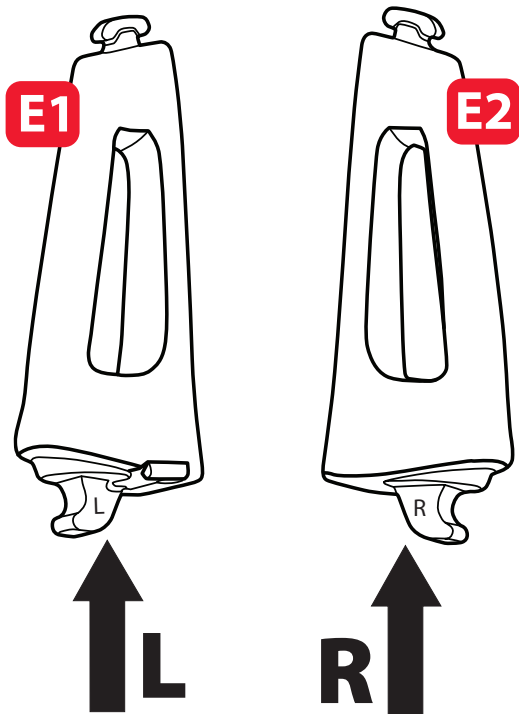

Roof Pillars - REAR

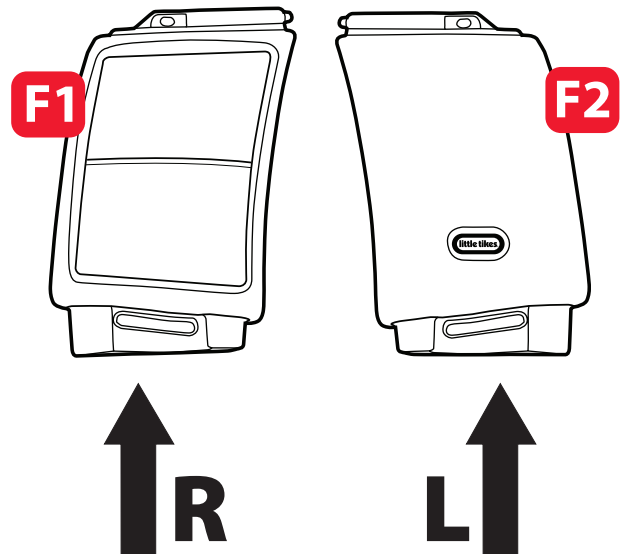

13a

FRONT pillars...Lock the door in place!

- 1** Insert the FRONT left roof support. Use one hand to rock the support back and forth, while pushing down with the other hand.

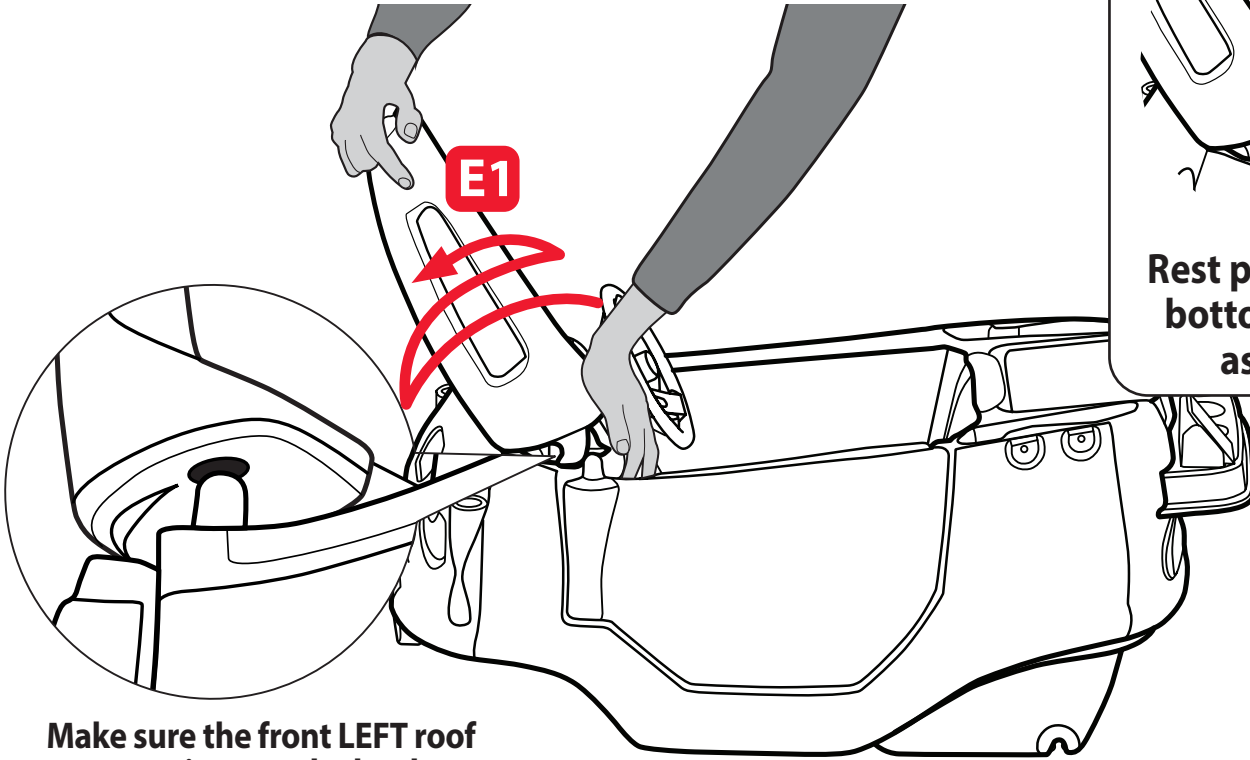

Make sure the front LEFT roof support sits over the knob on the Truck door.

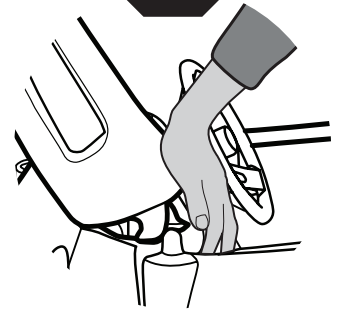

Rest palm against bottom of pillar as shown

- 2** Insert the FRONT right roof support. Use one hand to rock the support back and forth, while pushing down with the other hand.

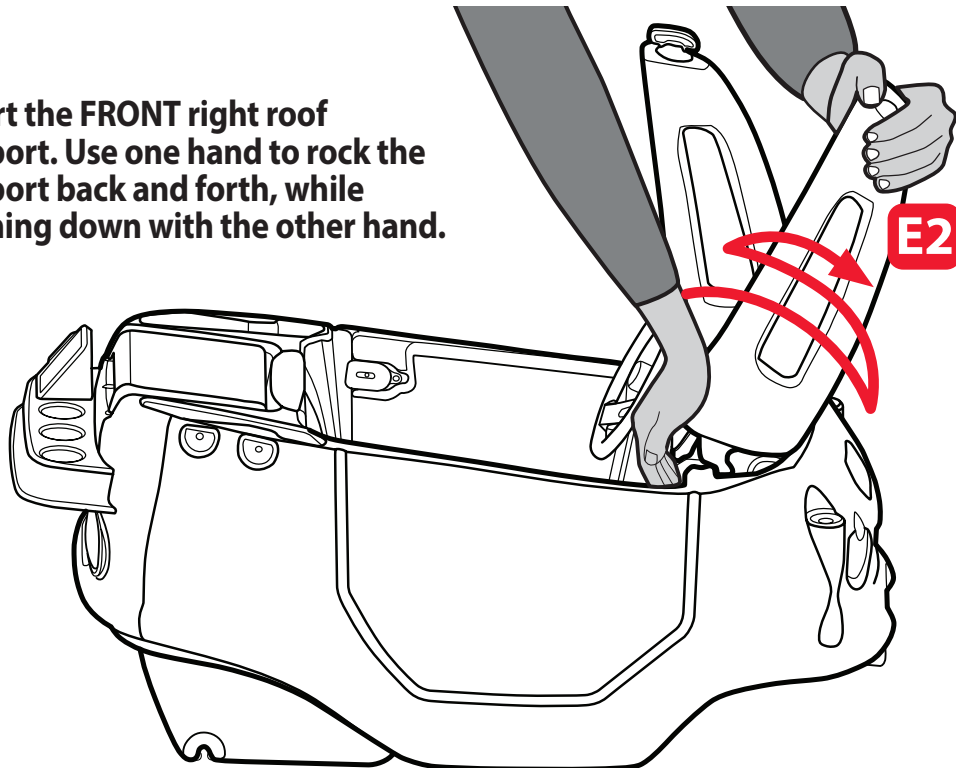

13b FRONT pillars...cont.

DO NOT insert the rear pillars yet!

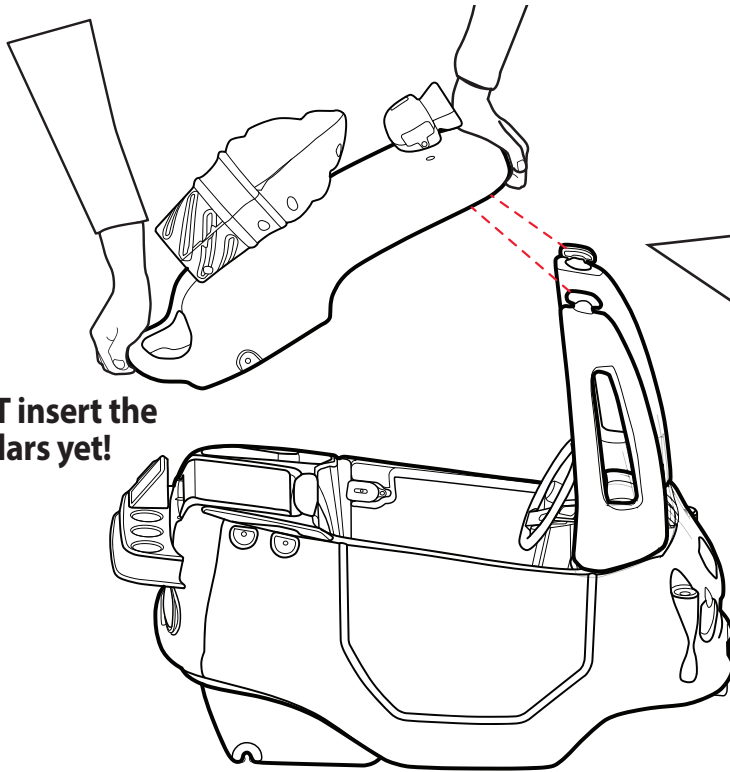

1

Hook the **ROUNDED END** of **FRONT** roof pillars (parts E1 & E2) into roof (part D).

2

Lift up on the rear of roof. The **FRONT** pillars (parts E1 & E2) will **SNAP** into place.

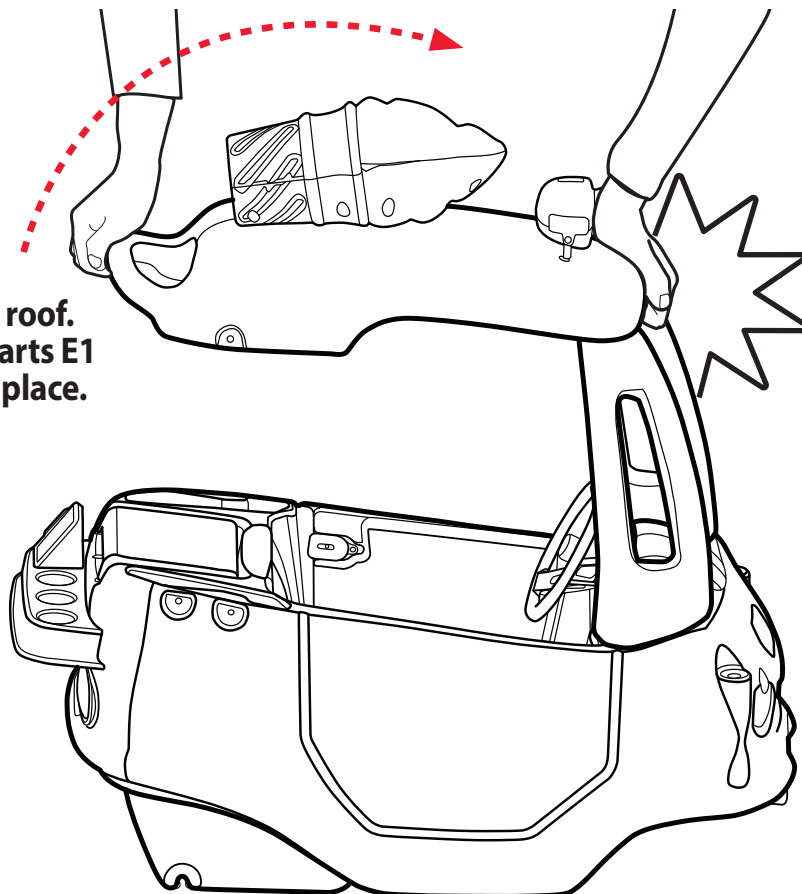

14 REAR pillars



BEFORE YOU START: match roof supports marked "L & R" to the correct side of roof also marked "L & R".

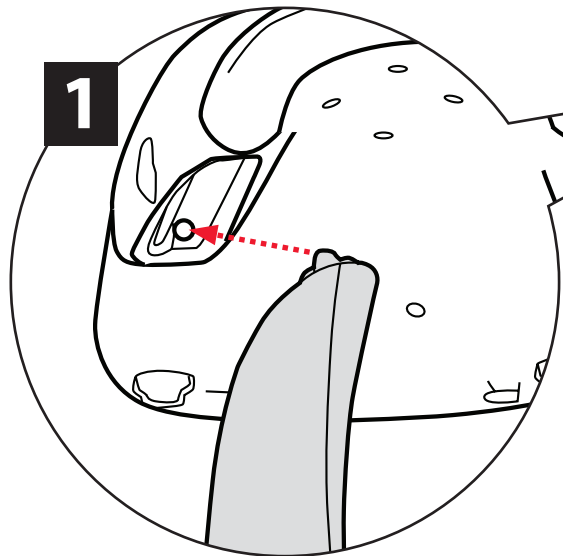

1 Insert post into hole in roof.

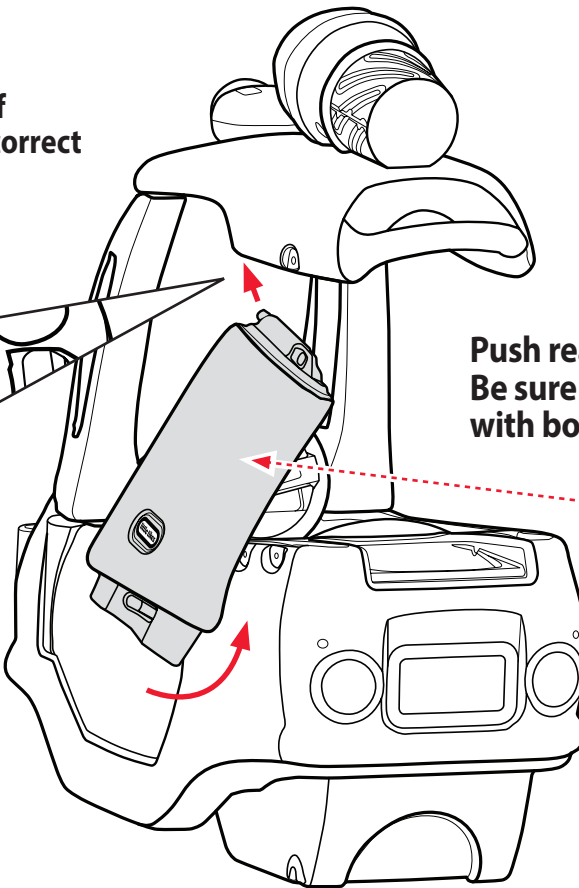

2

Push rear supports into place. Be sure supports are flush with body.

F2

REPEAT for other REAR pillar

3

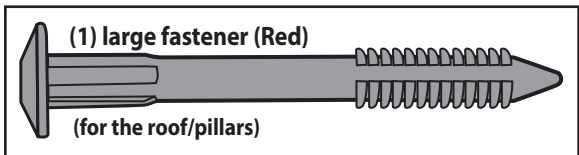

Align hole in pillar to hole in roof. Install (1) RED fastener.



BOTH rear pillars MUST be in position before installing fasteners.

4

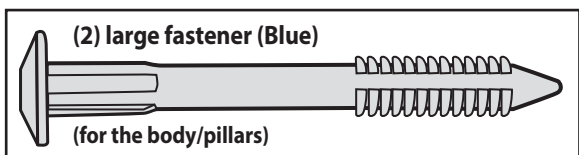

Align hole in pillar to hole in body. Install (2) BLUE fasteners.

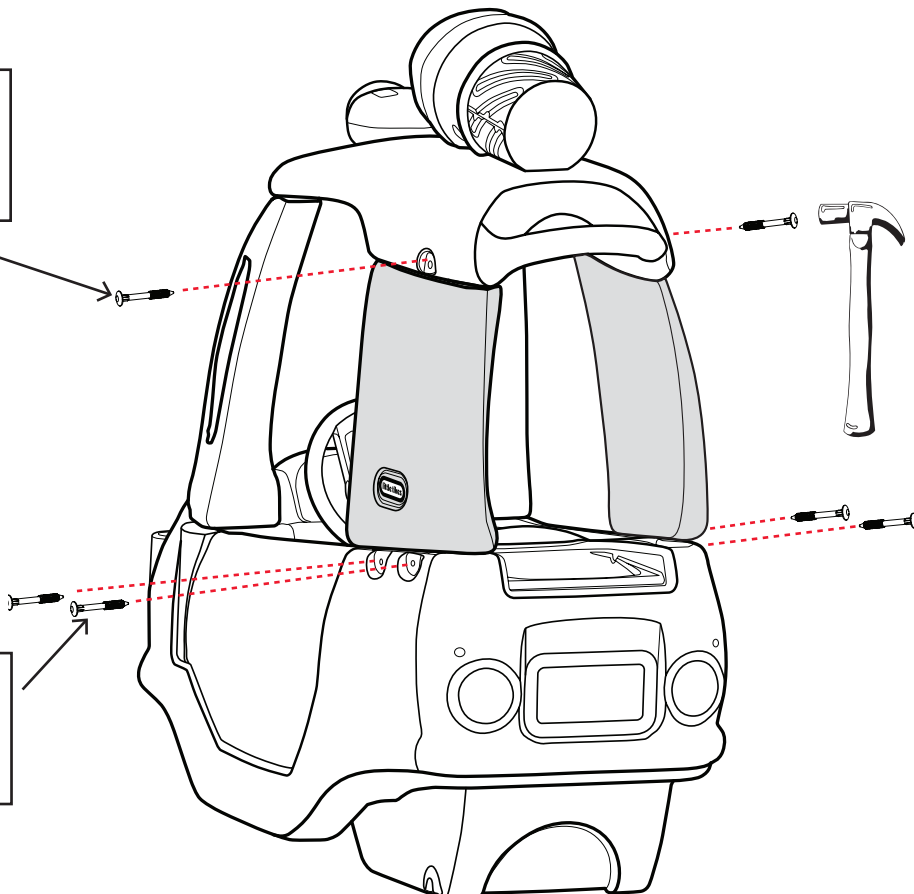

15a

REAR wheels...give it a good hit!

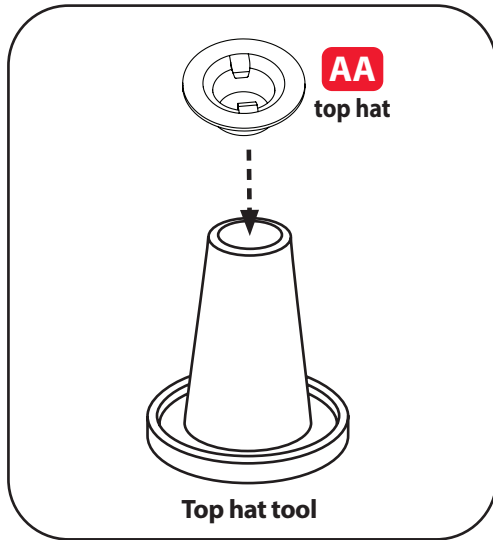

Place (1) top hat (part AA)
into top hat tool.

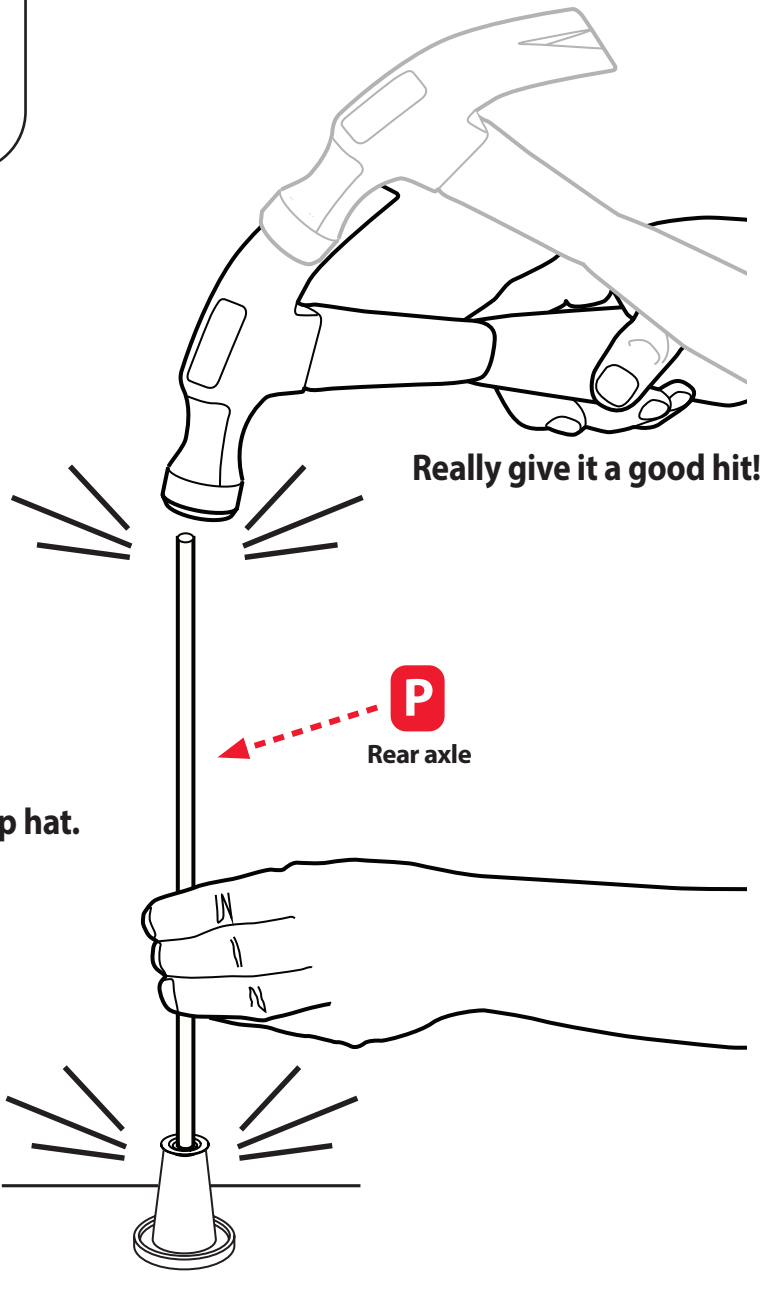

Insert the rear axle (part P)
into the top hat.
Hammer the axle into the top hat.

15b

REAR wheels...get in the groove.

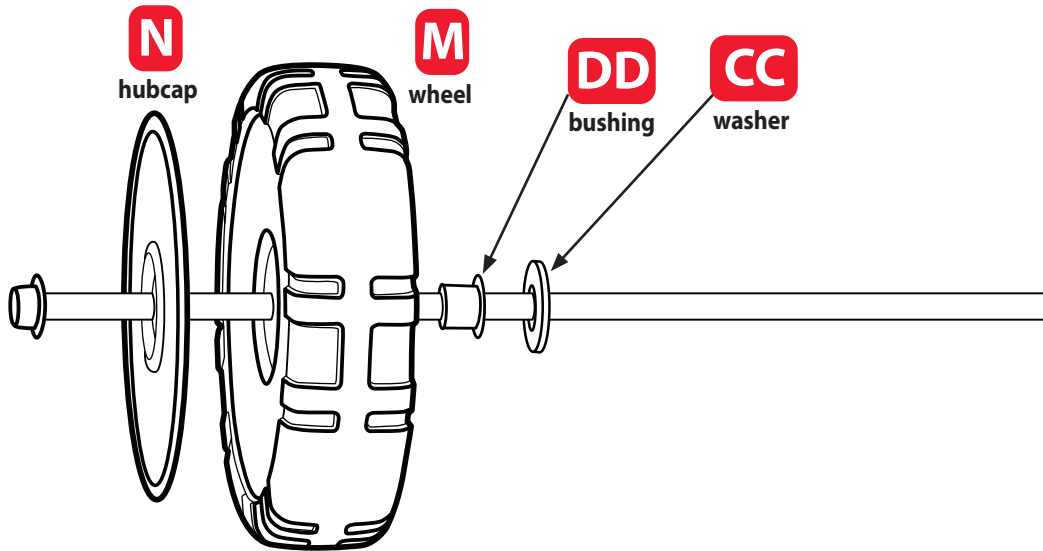

Slide onto rear axle (1) hubcap (N), (1) wheel (M), (1) rear axle bushing (DD) and (1) washer (CC).

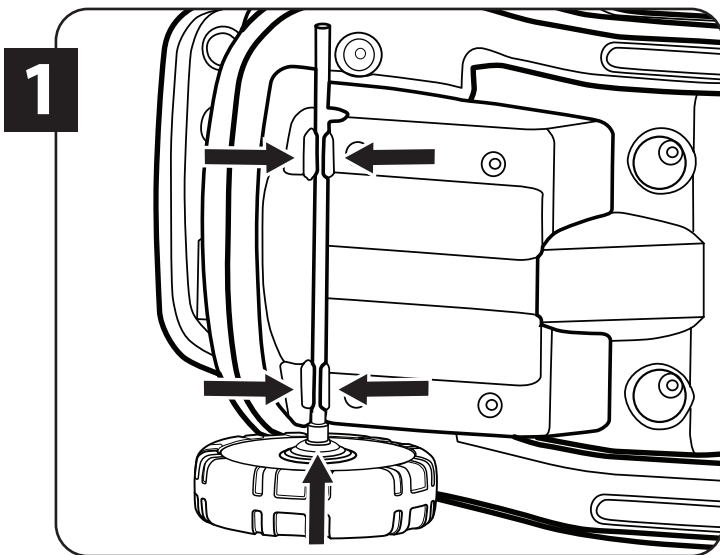

Slide assembled axle through rear axle guides.

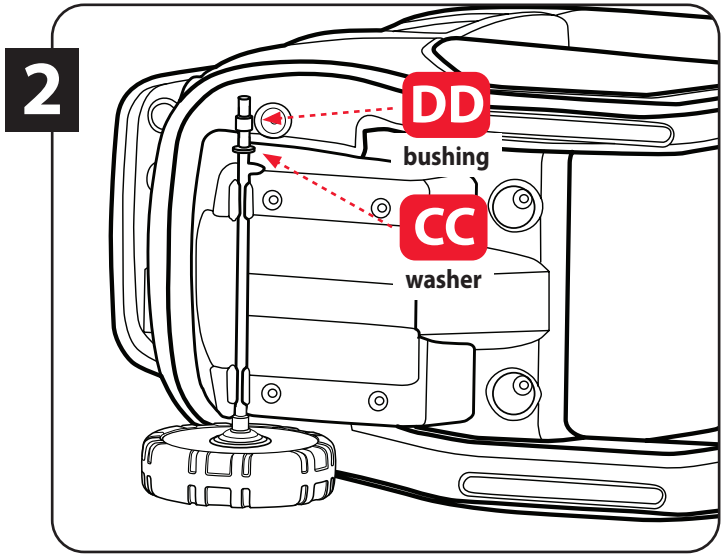

Slide (1) washer (CC) then (1) bushing (DD)

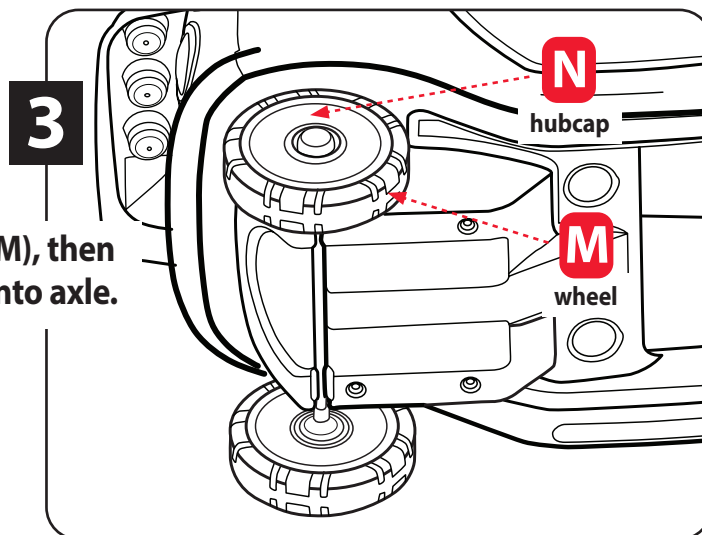

Slide wheel (M), then hubcap (N) onto axle.

15c REAR wheels...last step.

Flip the ice cream truck on its side.
Place a (1) top hat (AA) and the top hat tool over the OPEN end of the axle.
Hammer the top hat onto axle.

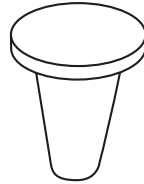
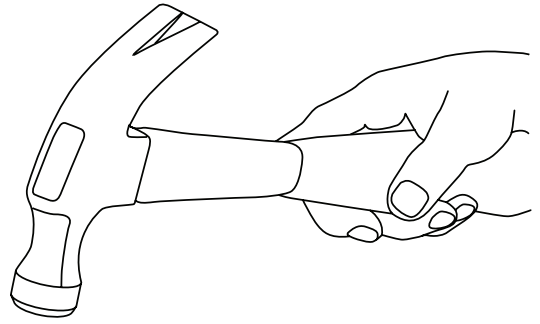

Top hat tool



AA Top hat

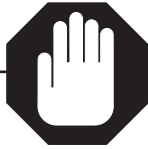

Do not hammer on surfaces or items you don't want to break, mar or dent.

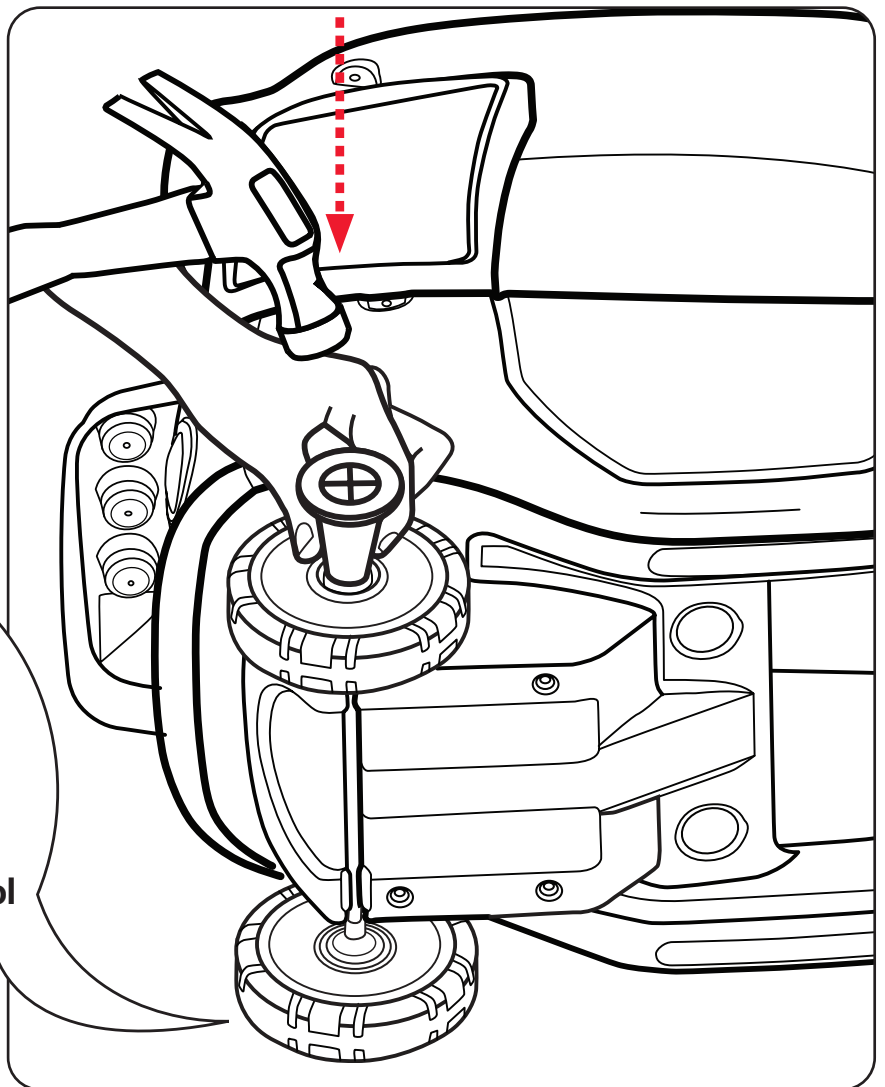

Use the tall axle cap tool to SUPPORT the bottom of axle.

16a

FRONT wheels...rolling along!

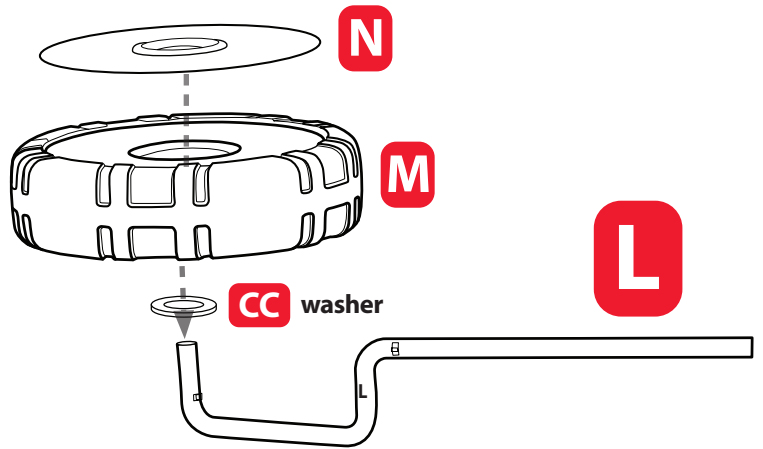
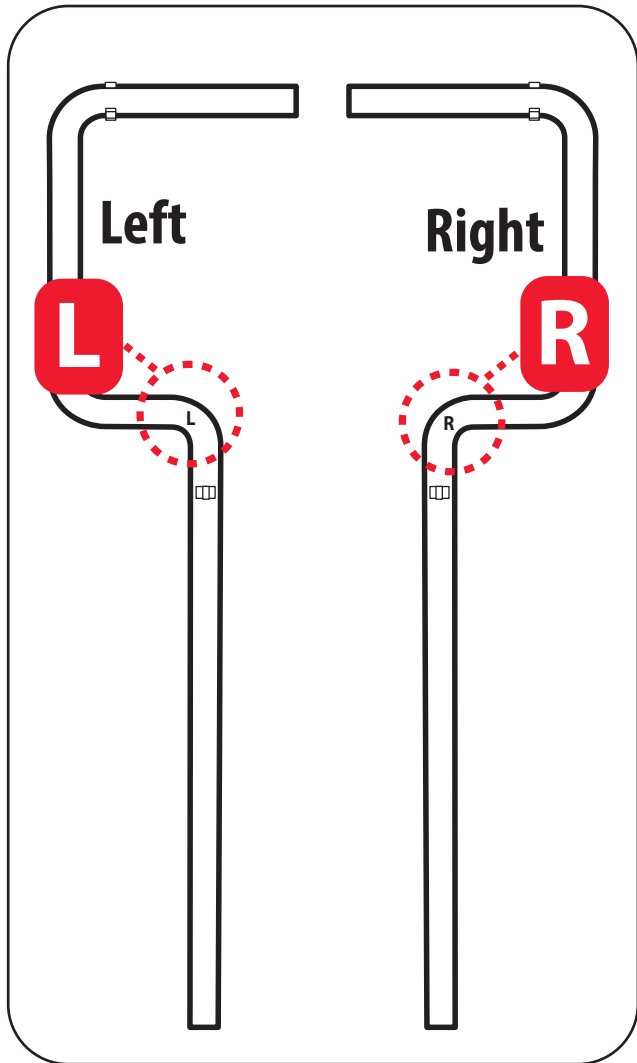

Slide onto LEFT front axle (L)
(1) washer (CC), (1) hubcap (N) and (1) wheel (M).

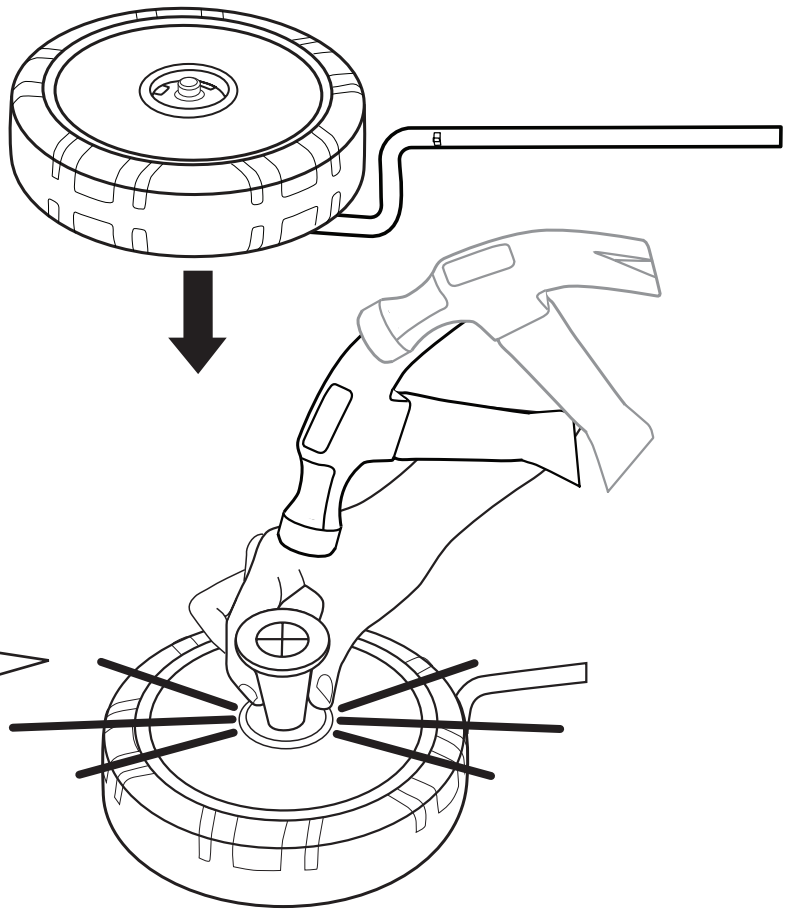

Place top hat then top hat tool onto open end of axle. Hammer top hat onto axle.

REPEAT these steps for RIGHT front axle

16b

FRONT wheels...almost there!

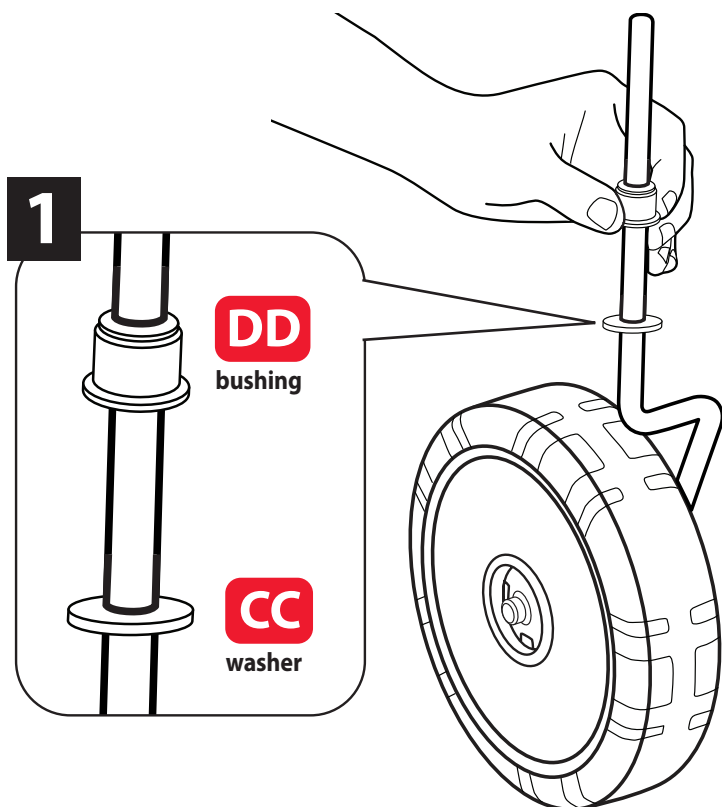

First, slide washer (CC), then bushing (DD) onto assembled right axle. REPEAT on left side.
Then, insert assembled FRONT wheels/axles.

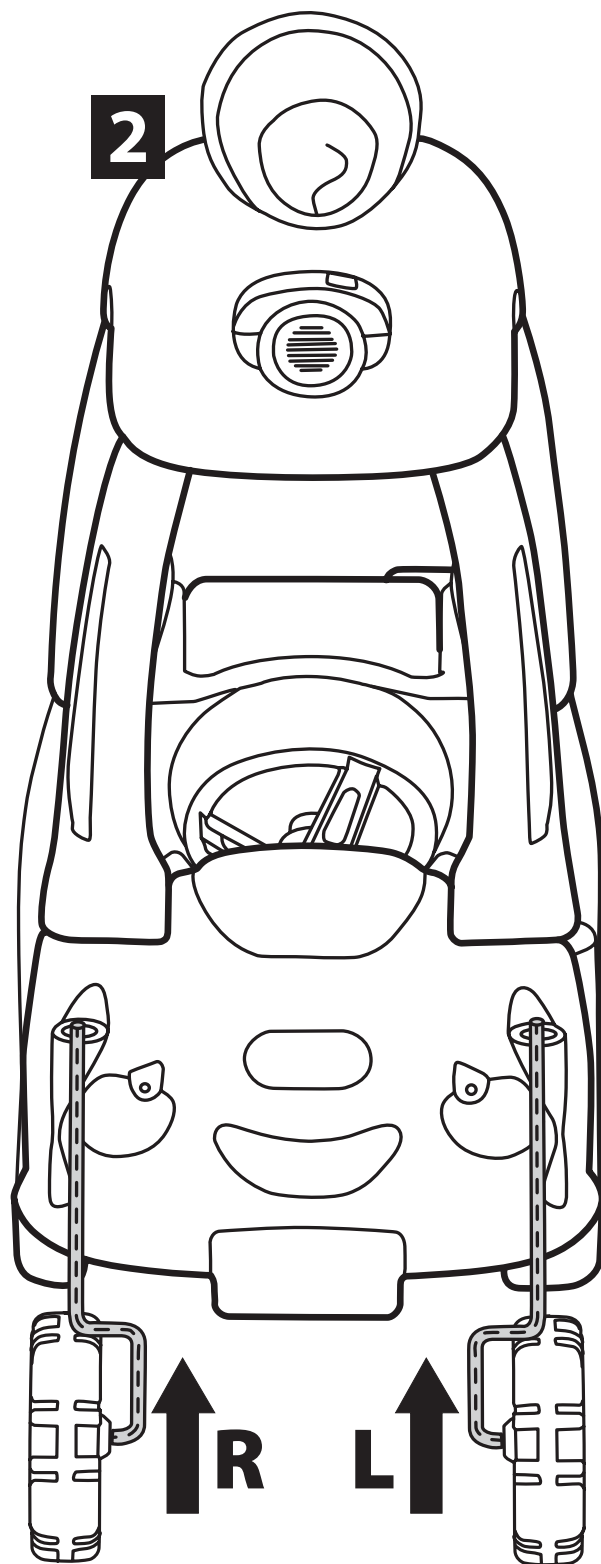

Insert axle "R"
(for right) into body.

Insert axle "L"
(for left) into body.



STOP

IMPORTANT! Check axle positions - roll the Ice Cream Truck forward - HUBCAPS SHOULD FACING OUTWARD.

CORRECT

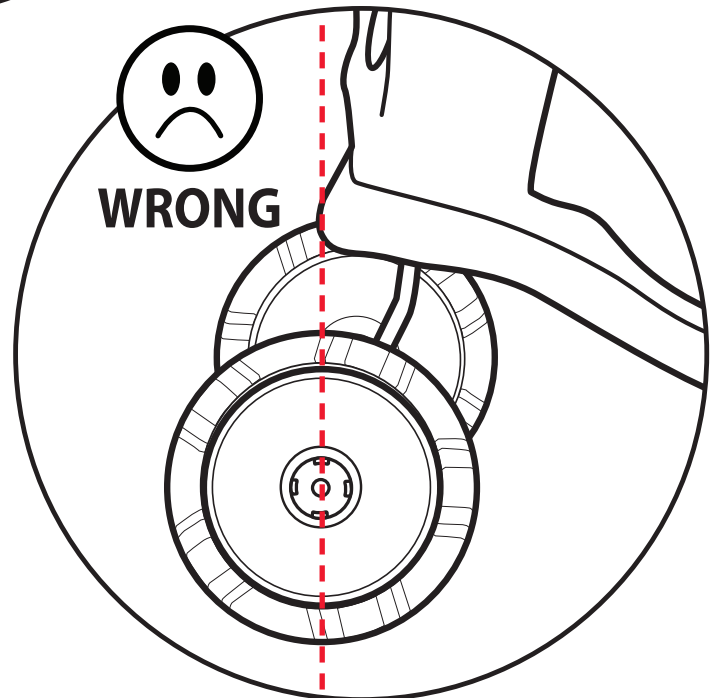
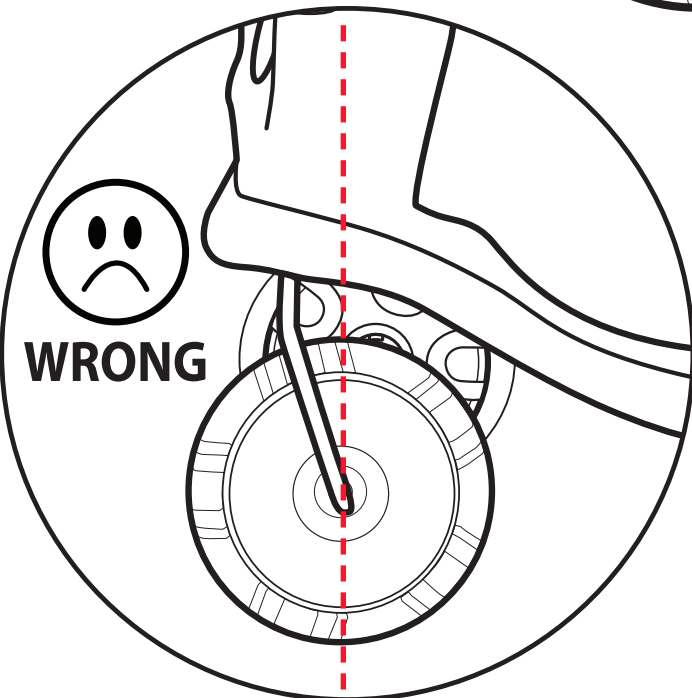
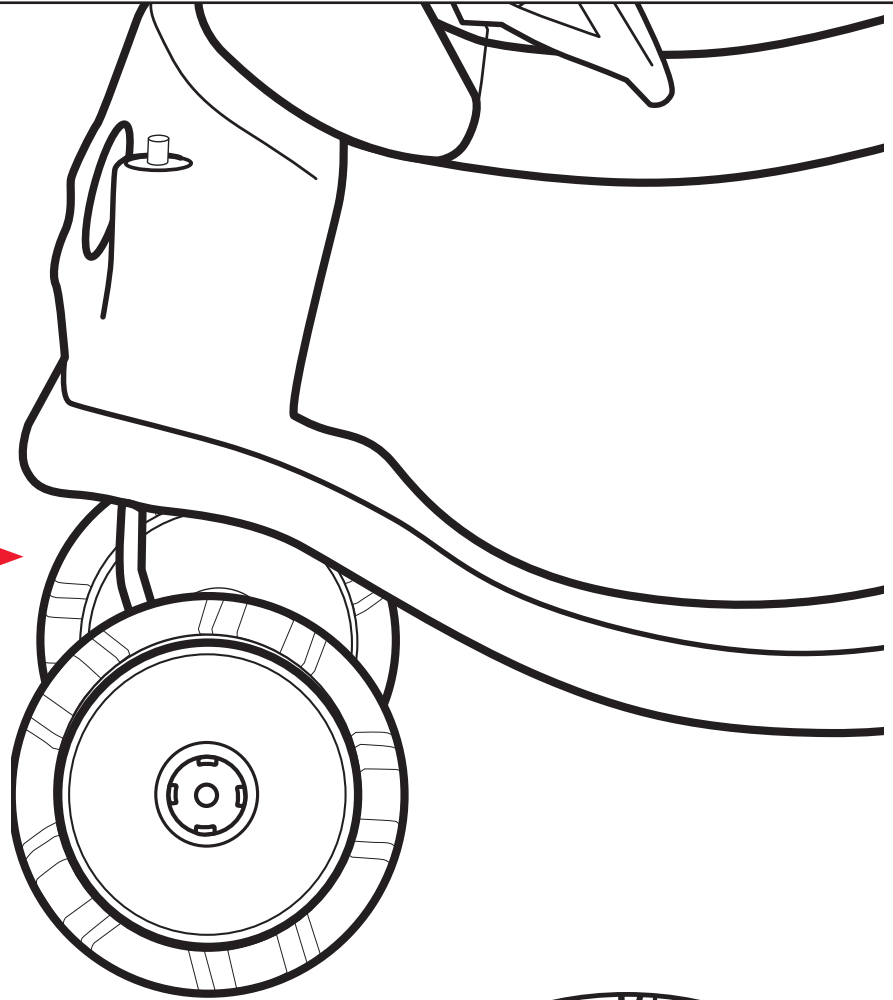

16c

FRONT wheels...last steps!

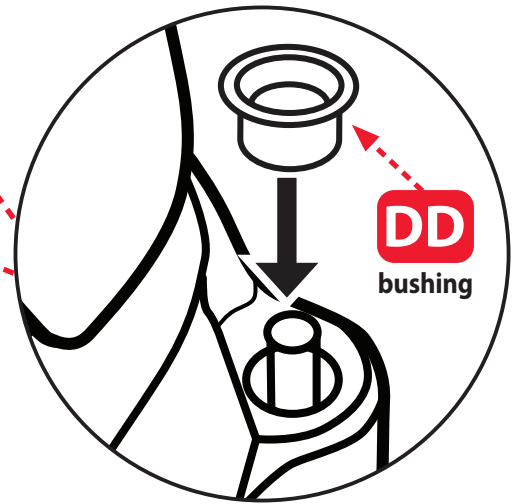
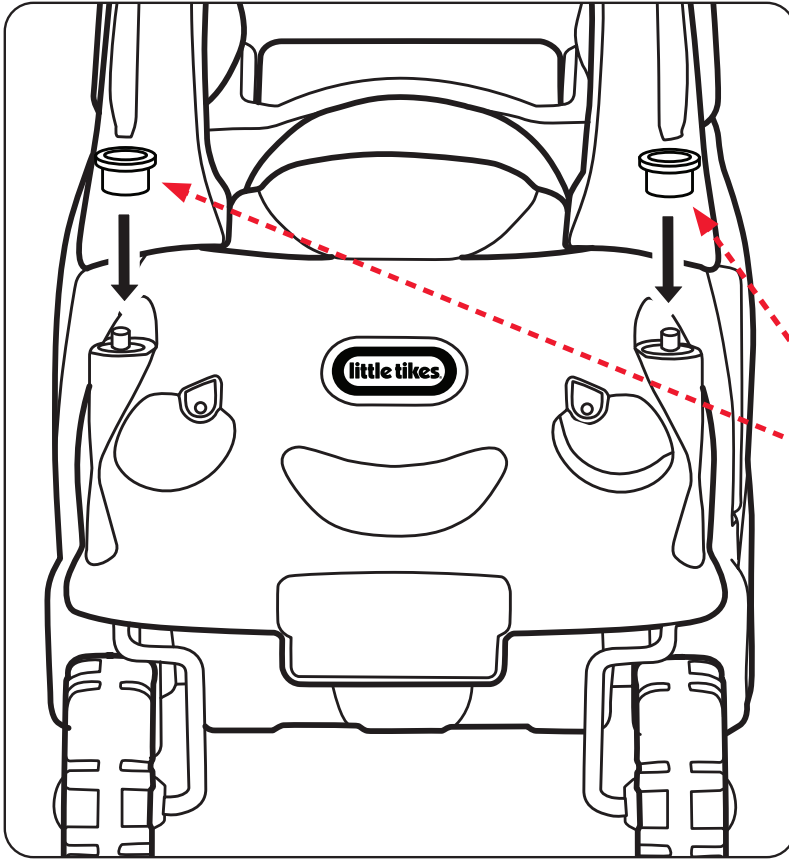

Insert bushing (DD) onto each axle and push in place

16d

Have to see where I'm going!

1 Place eye bases over exposed axles. Align openings and secure with a short fastener.

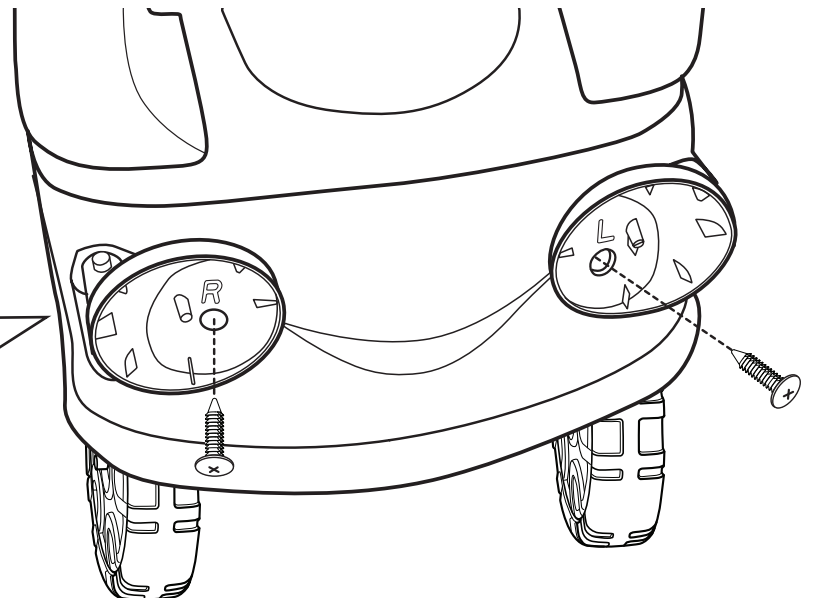
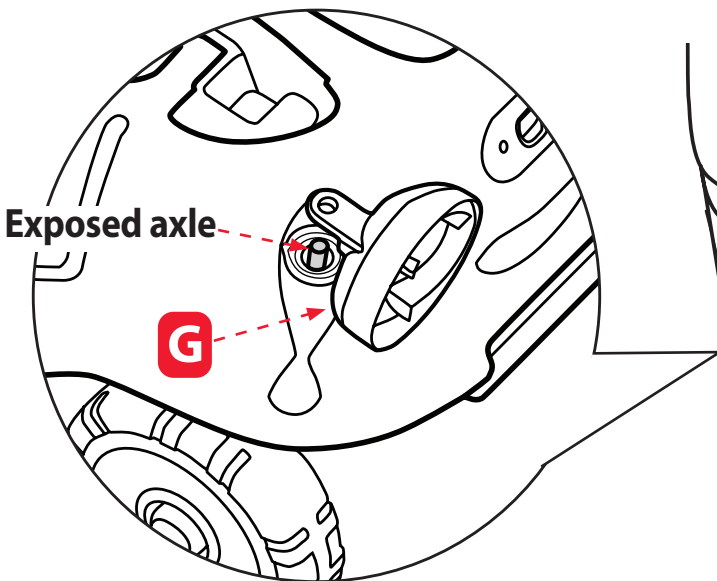
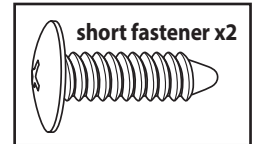
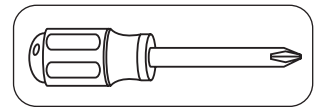

16d

Have to see where I'm going!...cont.

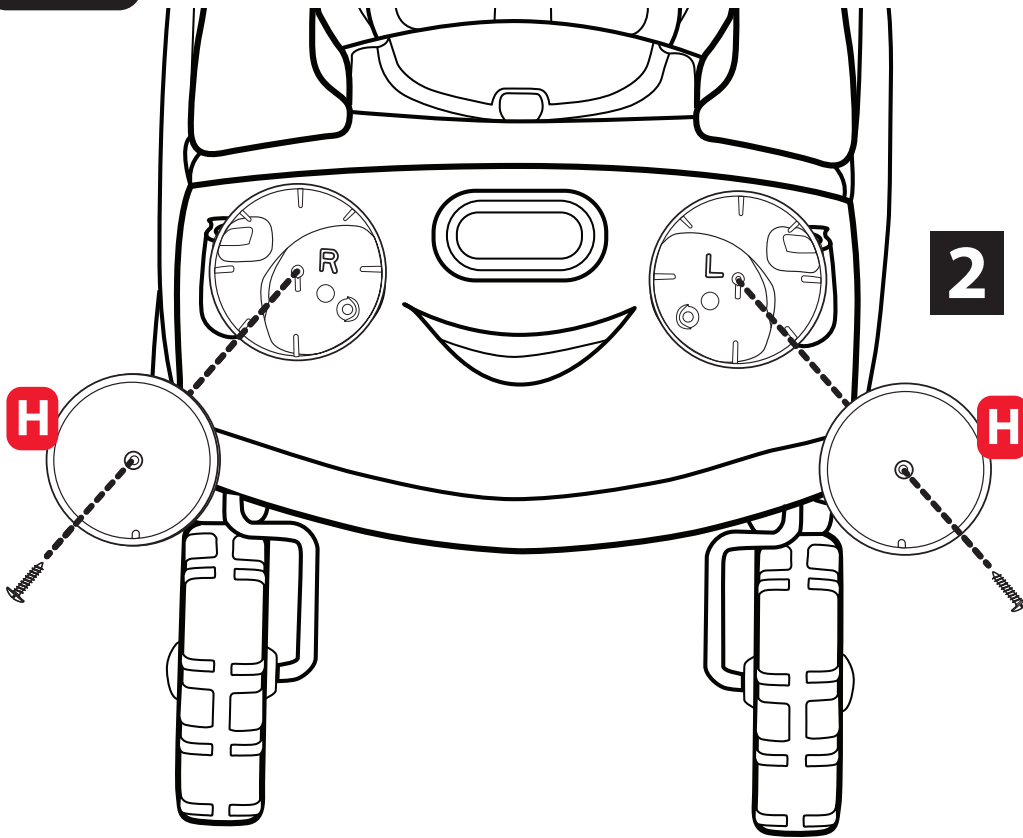
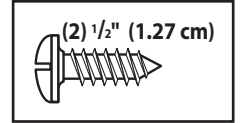
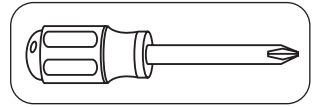

2 Attach eye covers (part H) to front of Truck with 1/2" (1.27cm) screw.

16e

Last step...really!

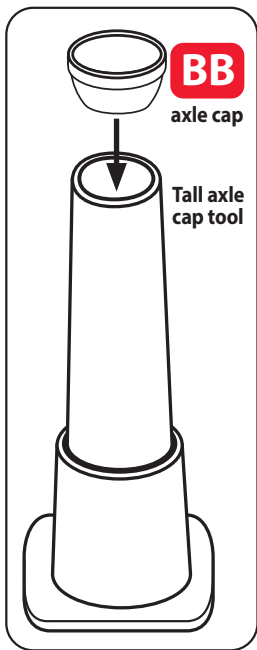

BB
axle cap

Tall axle cap tool

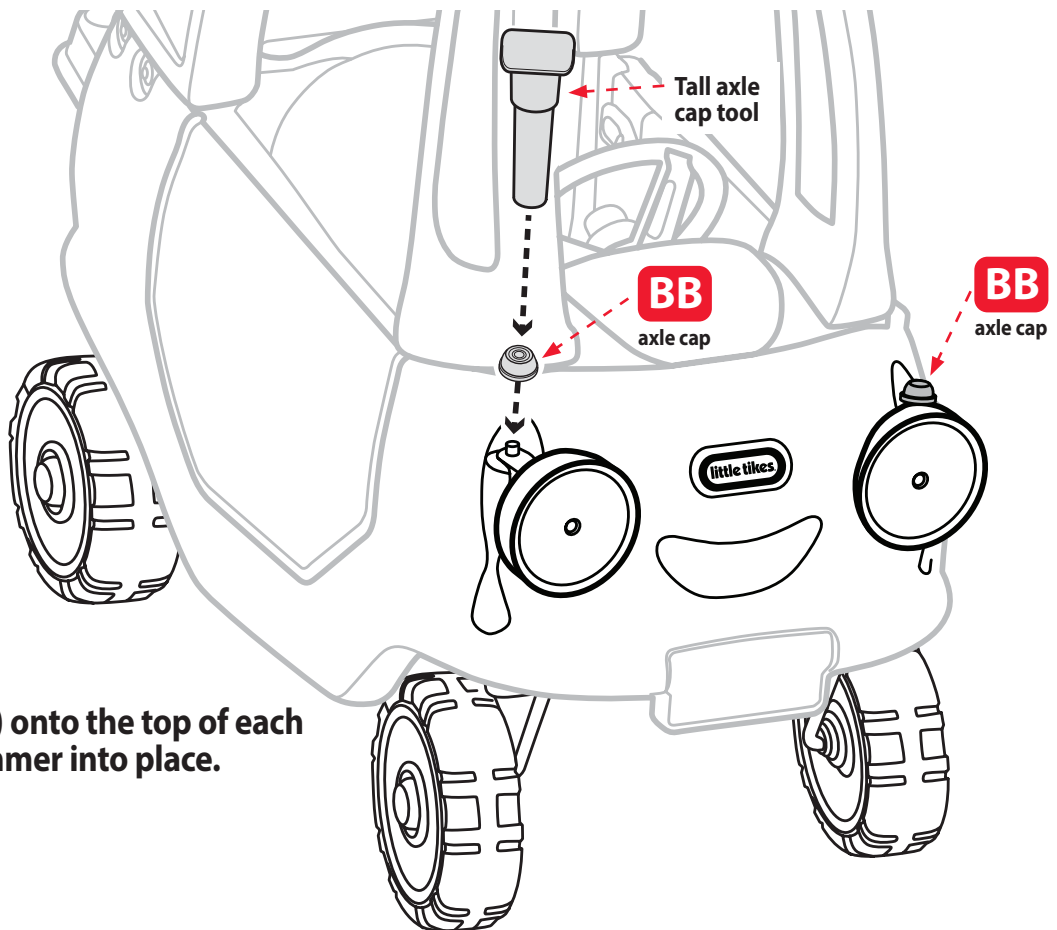

Tall axle cap tool

BB
axle cap

BB
axle cap

Insert axle cap (BB) onto the top of each axle and hammer into place.

17

Center Caps

Align slots and snap on (4) center caps (part O)

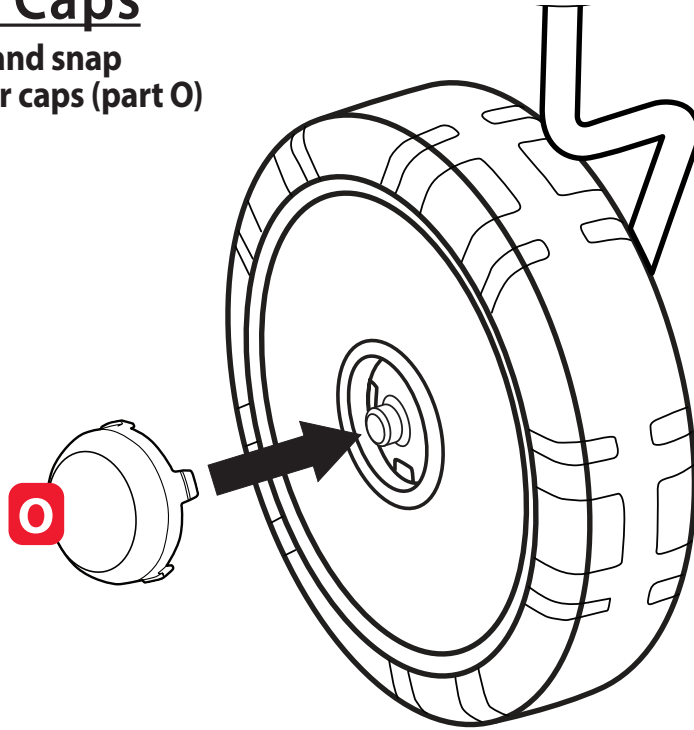

STOP

For parent controlled push rides, install the floorboard.

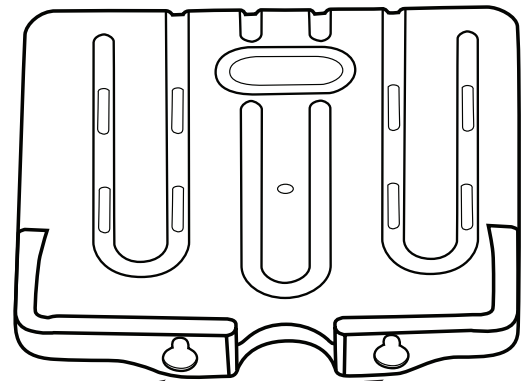
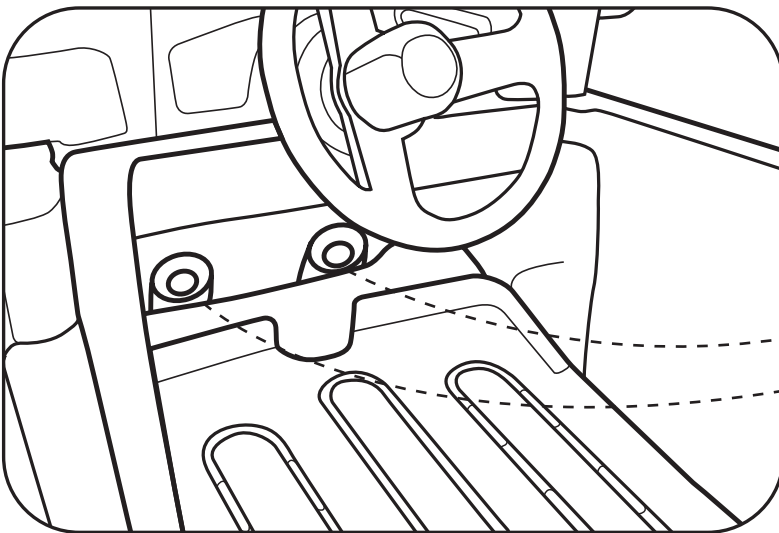

Line up openings in floorboard (part W) to floorboard buttons. Once buttons are inserted into floorboard, push down to secure in place.

18 Let's finish with the decals!

Decals must be applied to a clean, dry surface. Wipe clean with a dry rag before application. Remove air from under decals by applying pressure to the decals starting from the center, and work towards edges. NOTE: If decals bubble, prick with a pin to remove the air.

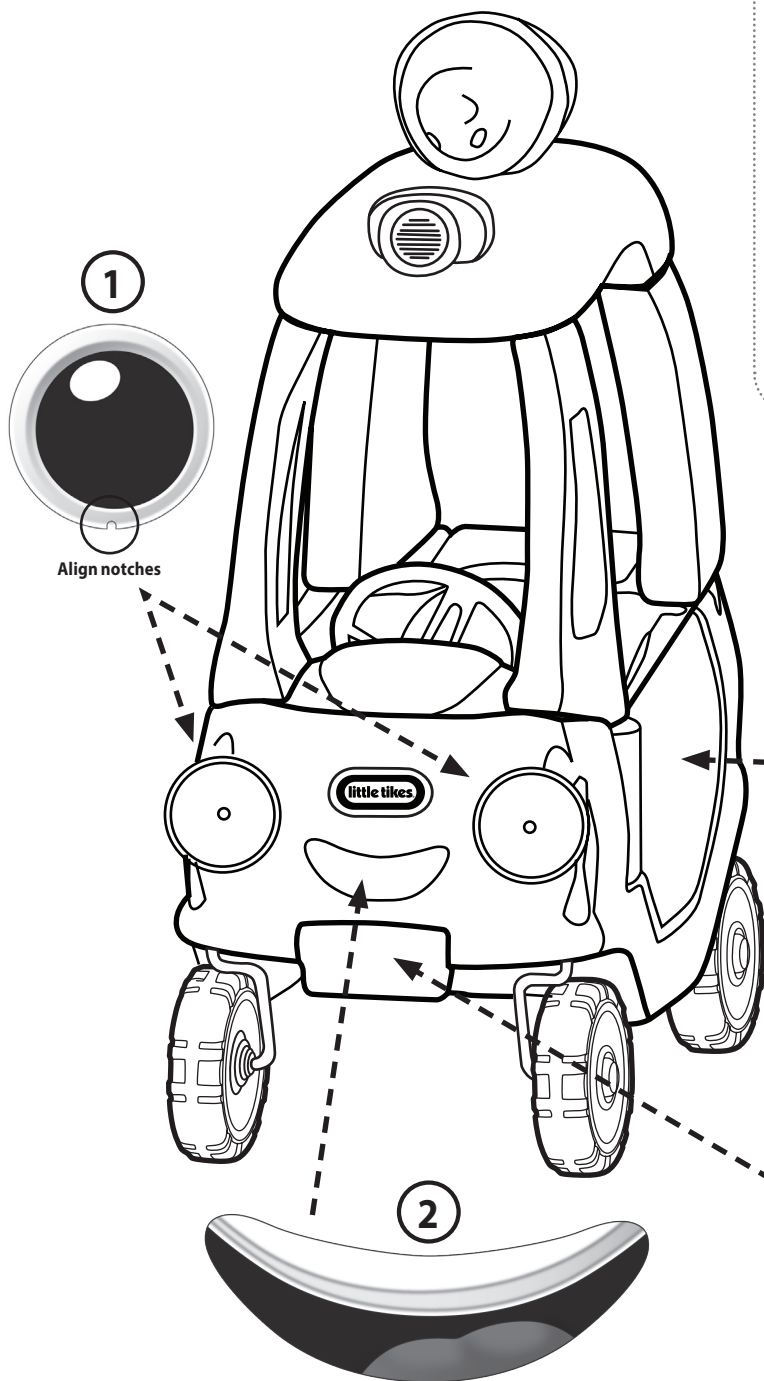

(2) Decal sheet is located in the hardware pack.

