

LIMITED WARRANTY

The Little Tikes Company makes fun, high quality toys. We warrant the original purchaser that the frame of this product is free of defects for 1 year from the date of purchase, and all other parts are free of defects in material or workmanship for 90 days* from the date of purchase (dated sales receipt is required for proof of purchase). At the sole election of The Little Tikes Company, the only remedies available under this warranty will be either replacement of the defective part or replacement of the product. This warranty is valid only if the product has been assembled and maintained per the instructions. This warranty does not cover abuse, accident, cosmetic issues such as fading or scratches from normal wear, or any other cause not arising from defects in material and workmanship.

U.S.A and Canada: For warranty service or replacement part information, please visit our website at www.littletikes.com, call 1-800-321-0183 or write to: Consumer Service, The Little Tikes Company, 2180 Barlow Road, Hudson OH 44236, U.S.A. Some replacement parts may be available for purchase after warranty expires—contact us for details.

*Trampoline Warranty:

We warrant to the original purchaser that the frame in this product is free of defects in materials or workmanship for 1 year from the date of purchase, and all other parts are free of defects in material or workmanship for 90 days from the date of purchase (dated sales receipt is required for proof of purchase).

Outside U.S.A and Canada: Contact place of purchase for warranty service.

This warranty gives you specific legal rights, and you may also have other rights, which vary from state to state. Some states do not allow the exclusion or limitation of incidental or consequential damages, so the above limitation or exclusion may not apply to you.



7FT TRAMPOLINE WITH SAFETY ENCLOSURE

SKU: 650635C

AGES: 5-10 YEARS

Assembly, Installation, Care, Maintenance and User Instructions



Please keep this manual as it contains important information.



0419-2-C

© The Little Tikes Company, an MGA Entertainment company. L.O.L. SURPRISE!™ is a trademark of MGA Entertainment, Inc. LITTLE TIKES® is a trademark of Little Tikes in the U.S. and other countries. All logos, names, characters, likenesses, images, slogan, and packaging appearance are the property of Little Tikes.

Printed in China

Little Tikes Consumer Service
2180 Barlow Road
Hudson, Ohio 44236 U.S.A.
1-800-321-0183

MGA Entertainment UK Ltd.
50 Presley Way, Crownhill,
Milton Keynes, MK8 0ES,
Bucks, UK
0800 521 558

MGA Entertainment (Netherlands) B.V.
Klipperaak 201, 2411 ND Bodegraven, NL
Tel: +31 (0) 172-758 038
E-mail: klantenservice@mga.nl

Imported by MGA Entertainment Australia Pty Ltd
Suite 2.02, 32 Delhi Road
Macquarie Park NSW 2113
1300 059 676



www.littletikes.com
www.littletikes.co.uk

⚠ WARNING

- Warning. Only for domestic use.
- Always close the net opening before jumping.
- Empty pockets and hands before jumping.
- Do not eat while jumping.
- Adult assembly and supervision required.
- You must thoroughly read these materials prior to assembling and using this trampoline / trampoline enclosure.
- Save this manual for future reference.
- Maximum weight of the user shall not exceed 105 lbs. (47.63 kgs)
- Do not allow more than one person on the trampoline (inside the trampoline enclosure) at any time.
- Do not allow young children to use unless supervised by an adult.
- This product is intended for domestic family use only.
- This product is intended for use by children ages 5 - 10 years.
- This product is recommended that at least 2 persons participate in the assembly of this product.

IMPORTANT INFORMATION

Trampolines are great fun when used correctly. Most injuries are caused during the use of the trampoline, not because of their construction.

Read these instructions and warnings carefully and ensure you follow them at all times. Follow all assembly and maintenance instructions closely to ensure the equipment is safe to use and lasts as long as possible.

⚠ WARNING - GENERAL

Read all instructions before using the trampoline and trampoline enclosure. Warnings and instructions for the care, maintenance, and use of this trampoline and trampoline enclosure are included to promote safe, enjoyable use of this equipment.

- This trampoline is only suitable for domestic family use. For outdoor use ONLY!
- The trampoline is not intended to be buried into the ground.
- Not recommended for use by children under 5 years or over 10 years of age. Max. weight limit: 105 lbs. (47.63 kgs).
- The trampoline is designed for installation on flat surfaces with at least 6'6" (2m) clear space around the trampoline.
- Do not place on a hard surface (i.e. concrete or asphalt) serious injury may occur.
- Above the trampoline, ensure there is clear and free space to the expected jumping height, it is strongly advised not to place the trampoline under the canopy of surrounding trees.
- Inspect the trampoline and trampoline enclosure before use. Make sure the frame padding is correctly and securely positioned. Replace any worn, defective, or missing parts.
- For further information or additional instruction materials on skill training, contact a competent trampoline instructor.

⚠ WARNING - USAGE

- Do not attempt or allow stunts including somersaults, these are dangerous moves that should only be performed in the presence of a skilled trainer, and with appropriate equipment, serious injury is likely to occur if stunts are attempted on this trampoline. Landing on the head or neck can cause serious injury, paralysis or death, even when landing in the middle of the bed.
- Children and unpracticed users must always jump under supervision by an experienced person, it is strongly recommended to use spotters at all times.
- Do not allow more than one person on the trampoline (inside trampoline enclosure). Use by more than one person at the same time can result in serious injury.
- Use trampoline and trampoline enclosure only with mature, knowledgeable supervision.
- Do not use if you are suffering from an injury (i.e. ankle or knee injury) or while pregnant.
- Remove glasses, watches, jewelry and chains, ornaments, clasps and other sharp objects. Empty your pockets before starting to jump.
- Do not use the trampoline in the dark.
- Do not put any objects or toys on the trampoline and trampoline enclosure.
- Animals are not allowed on the trampoline and trampoline enclosure.
- Do not smoke while using the trampoline.
- Do not use when wet.
- Do not use the trampoline while under the influence of alcohol or drugs.

To assemble this trampoline, you need Phillips screwdriver (not included) and our special spring loading tool provided with this product.

During periods of non-use, this trampoline can be easily disassembled and stored.

Please read the assembly instructions before beginning to assemble the product.

It is recommended that at least 2 persons participate in the assembly of this product.

- Jumpers must wear socks, gymnastic shoes, or be barefoot when using the trampoline. Please be aware that street shoes or tennis shoes should NOT be worn while using the trampoline.
- Jumpers should remove all sharp objects from their person prior to using the trampoline. Any type of sharp or pointed objects should be kept off the trampoline mat at all times.
- Initially, you should get accustomed to the feel and bounces of the trampoline. The focus must be on the fundamentals of your body position and you should practice each bounce (the basic bounces) until you can do each with skill and control.
- To break a bounce, all you need to do is flex your knees sharply before they come in contact with the mat of the trampoline. This technique should be practiced while you are learning each of the basic bounces. The skill of braking should be used whenever you lose balance or control of your jump.
- Always learn the simplest bounce first and be consistent with the control of your bounce before moving on to more difficult and advanced bounces. A controlled bounce is one when your take "off" point and landing point is the same spot on the mat. If you move up to the next bounce without first mastering the previous, you increase your chances of getting injured. Do not bounce on the trampoline for extended periods of time because fatigue can increase your chance of injury.
- Misuse and abuse of this trampoline is dangerous and can cause serious injury! Trampolines being a rebounding device, propel the performer to unaccustomed heights and into a variety of body movements.
- Always inspect the trampoline and trampoline enclosure before each use for worn-out mat, loose or missing parts.
- Climbing on and off the trampoline. It is a dangerous practice to jump from the trampoline to the floor or ground when dismounting, or to jump onto the trampoline when mounting. Do not use the trampoline as a springboard to other objects.
- Stop bouncing by flexing knees as feet come in contact with the trampoline bed. Learn this skill before attempting others.
- Avoid bouncing too high. Stay low until bounce control and repeated landing in the center of the trampoline can be accomplished. Control is more important than height.
- While keeping the head erect, focus eyes on the trampoline toward the perimeter. This will help control bounce.
- Keep objects away which could interfere with the performer. Maintain a clear area around the trampoline.
- Bounce only when the surface of the bed is dry. Wind or air movement should be calm and gentle. The trampoline must not be used in gusty or severe winds.
- Bounce in the center of the bed.
- Avoid bouncing when tired. Keep turns short.
- Properly secure the trampoline and trampoline enclosure when not in use. Protect it against unauthorized use.
- For additional information concerning the trampoline equipment, contact the manufacturer.
- Users may become entangled in or strangled by loose cords or in gaps between trampoline and enclosure.
- Keep enclosure tightly fastened to the trampoline in accordance with the manufacturer's instructions. Failure to properly assemble and maintain a tight, secure trampoline/enclosure boundary may result in serious injury, strangulation, or death.
- Do not attempt to jump over the trampoline enclosure.
- Do not attempt to crawl under the trampoline enclosure.
- Do not intentionally rebound off the trampoline enclosure.
- Do not hang from, kick, cut, or climb on the trampoline enclosure.
- Wear clothing free of drawstrings, hooks, loops or both.
- Do not attach anything to the trampoline enclosure that is not a manufacturer-approved accessory or part of the enclosure system.
- Enter and exit the trampoline enclosure only at the opening designated for that purpose.

Care, Maintenance and Use Instructions MUST be read carefully before using the trampoline!

Care and Maintenance

This trampoline and trampoline enclosure were designed and manufactured with quality materials and craftsmanship. If proper care and maintenance is provided, it will provide all jumpers with years of exercise, fun, and enjoyment as well as reduce the risk of injury. Please follow the guidelines listed below:

- This trampoline is designed to a certain amount of weight and use. Person should weigh less than 105 lbs. (47.63 kgs).
- Please make sure that only one person at any one time uses the trampoline.
- In order to prevent the trampoline mat from getting cut or damaged please do not allow any pets onto the mat.
- Always inspect the trampoline and enclosure before each use for worn, defective or missing parts. A number of conditions could arise that may increase your chances of getting injured. Please be aware of:
 - Missing, improperly positioned, or insecurely attached frame padding, trampoline enclosure or frame padding and pole caps.
 - Punctures, frays, tears, or holes worn in the bed, barrier or support system (frame) padding.
 - Deterioration in the stitching or fabric of the bed, barrier or support system (frame) padding.
 - Bent or broken frame.
 - Ruptured springs.
 - A sagging trampoline bed.
 - Broken, missing, or damaged springs.
 - Protrusions of any types (especially sharp) on the frame, springs, or mat.
 - In certain countries during winter period, the snow load and the very low temperature can damage the trampoline. It is recommended to remove the snow and store the mat and the enclosure indoor.
 - Replace the net after two years of use.

IF YOU FIND ANY OF THE PREVIOUS CONDITIONS, OR ANYTHING ELSE THAT YOU FEEL COULD CAUSE HARM TO ANY USER, THE TRAMPOLINE SHOULD BE DISASSEMBLED OR SECURED FROM USE UNTIL THE CONDITION(S) HAS BEEN RESOLVED.

Carry out checks and maintenance of the main parts (frame, suspension system, bed, pads and enclosure) at regular intervals. If these checks are not carried out the trampoline could become dangerous.

It is of particular importance that these be followed at the beginning of each season, as well as at regular intervals during the usage season.

- Check all nuts and bolts for tightness and tighten when required.
- Check all spring loaded (pit-pin) joints are still intact and cannot come undone during play.
- Check all coverings for bolts and sharp edges and replace when required.
- Check for evidence of wear or deterioration and replace if needed in accordance with these instructions.
- Make sure dry enough for storage.

High Wind

Do not use or stand near the trampoline in windy or gusty conditions. A trampoline can become airborne when exposed to sustained wind or gusting wind conditions. This can result in serious injury, paralysis, or death, as well as property damage. To reduce these risks, disassemble the trampoline and enclosure and store them until weather conditions improve. Anchoring a trampoline frame may prevent the trampoline from moving as a result of the wind, but even anchored trampolines can become airborne or damaged. Consult a qualified contractor to determine what type of anchor works best in your location.

If you expect high winds, the trampoline should be moved to a sheltered location, taken apart, or tied down to the ground with ropes and stakes (not included). At least three ropes and three stakes should be used. Make sure to attach the ropes to the top of the frame; do not simply secure the legs or the bases to the ground, as they can separate from the frame sockets. The top of the stakes should be covered, if necessary, so that users will not be injured by falling onto the stakes.

Moving the Trampoline

If the trampoline needs to be moved, it should be moved by two persons, kept horizontal, and lifted slightly. All connector points should be wrapped and secured with weather resistant tape, such as duct tape. This will keep the frame intact during the move and prevent the connector points from dislocating and separating. If necessary, the trampoline can be taken apart for moving. To take the trampoline apart, follow the assembly steps in reverse order (steps 1-7). Do not attempt to take frame sections, legs, or bases apart before the mat and springs have been removed.

Assembly and Moving Hints!

Select a location where you want the trampoline permanently prior to assembly. Do not pick up the frame more than 2 inches off the ground, picking it up too high can cause the frame to warp.

If the frame does warp, put the trampoline down, press down on the part that is warped, The tension of the springs will flatten the frame.

Disassembly

To disassemble the trampoline, follow assembly STEP 1 through STEP 7 in reverse order. Do not attempt to disassemble any frame components before the springs and the mat have been removed. Use gloves to protect your hands from pinch points during disassembly.

ASSEMBLY INSTRUCTIONS

⚠ IMPORTANT NOTICE

NEVER use the trampoline without attaching the frame pad. Properly tie down the frame pad before each use!

Flip up the safety pad stitched with the trampoline mat. Tie the elastic straps over the frame, and make sure the safety pad covers the frame and all springs.

DO NOT use the trampoline if even one spring or triangle-ring is damaged or missing.

Perform a complete inspection of the trampoline to make sure all parts are assembled and attached properly.

Read this entire manual and make sure all jumpers completely understand all of the safety rules printed in the manual and on the various warning signs. Instruct all jumpers in the basic bounces described in the manual.

STEP 7 - Enclosure, Mat And Accessories Assembly

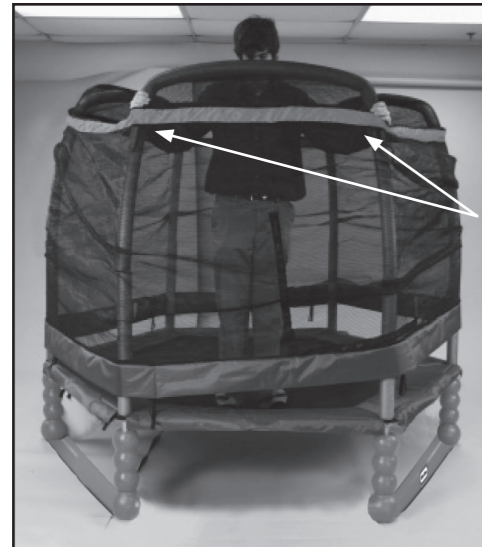

Enclosure netting should wrap around the outside of the straight frame and curve frame tubes. Pull over the enclosure evenly all the way round and work it down.

Adjust netting arch pocket to fit by pulling down the two ends of the pocket. Pockets should be secured on each of the 3 arches. Velcro® the pockets shut, securing the frame and netting.



After all three "arches" are attached to the enclosure assembly, pull the enclosure netting down and over the straight frame and curve frame tubes as shown.



Tie the elastic straps on trampoline mat (A) and enclosure netting (B) to the top rail (G). Loop around the frame and secure with a knot. Make it with 1" distance.



Tie the elastic straps on enclosure netting (B) to the corner top rail with socket (E). Loop around the frame and secure with a knot.



Attach elastic ties on shoe bag (V) by tying to the trampoline frame.

Trampoline Placement

Please read the entire instruction booklet before you assemble or use this trampoline!
Make sure the assembled trampoline is on level ground.

⚠ WARNING-PLACEMENT-OUTDOOR USE ONLY

- Place the trampoline on a level surface before use.
- Lateral (sideways) clearance is also essential. Place the trampoline away from walls, structures, fences and other play areas. Maintain a clear space on all sides of the trampoline and trampoline enclosure.
- Use the trampoline and the trampoline enclosure in a well-lighted area.
- Remove any obstructions from beneath the trampoline.
- Secure trampoline and trampoline enclosure against unauthorized and unsupervised use.

- The trampoline enclosure is only to be used as an enclosure for a trampoline of a size for which the enclosure is designed.
- The owner and supervisors of the trampoline are responsible to make all users aware of practices specified in this manual.

Do not install trampoline on concrete, asphalt or any other hard surface.

- Adequate overhead clearance is essential. A minimum of 24 ft from ground level is recommended. Provide clearance from wires, tree limbs, and other possible hazards. Please be aware of the following when selecting a place for your trampoline:
 - Make sure it is placed on a level surface at least 6'6" (2m) from any structure or obstruction such as a fence, garage, house, overhanging branches, laundry lines or electrical wires.

Labeling

TRAMPOLINE SAFETY INSTRUCTIONS

⚠ WARNING: This trampoline is intended for outdoor use only. Adult supervision required. Always close the net opening before jumping. The net should be replaced every two years.

ONLY ONE PERSON AT A TIME IN THE TRAMPOLINE ENCLOSURE. MULTIPLE JUMPERS INCREASE THE CHANCES OF LOSS OF CONTROL AND THIS CAN RESULT IN BROKEN HEAD, NECK, BACK OR LEG.

DO NOT LAND ON HEAD OR NECK. PARALYSIS OR DEATH CAN RESULT, EVEN IF YOU LAND IN THE MIDDLE OF THE TRAMPOLINE MAT (BED). DO NOT DO SOMERSAULTS (FLIPS).

B. NOTICE TO JUMPER

- Users may become entangled in or strangled by loose cords or in gaps between trampoline and enclosure.
- Use trampoline only with mature, knowledge supervision.
- Keep enclosure tightly fastened to the trampoline in accordance with the manufacturer's instructions. Failure to properly assemble and maintain a tight, secure trampoline/enclosure boundary may result in serious injury, strangulation or death.
- Do not use the trampoline and trampoline enclosure when under influence of alcohol or drugs. Do not smoke while using the trampoline and the trampoline enclosure.
- Inspect before use. Keep frame padding in place.
- Always have a supervisor watching you when you using the trampoline, do not jump unsupervised.
- No more than one person should jump on the trampoline at one time.
- Avoid jumping or bouncing for prolonged periods of time or too high for a number of jumps. Maintain control. Do not try to jump over the barrier. Do not intentionally rebound off the barrier. Do not hang from, kick, cut, or climb on the barrier while using product. While keeping the head erect, focus eyes on the trampoline toward the perimeter. Avoid jumping or bouncing when tired.
- Climb on and off the trampoline at the enclosure door or barrier opening in a control and careful manner. Never jump on or off the trampoline and never use the trampoline as device to bounce into or onto another objects. Do not crawl under the barrier. Do not use the trampoline as a springboard to other objects.
- Always Learn fundamental bounces and body positions thoroughly before trying more difficult types of bounces. Review the Basic Skills section to learn how to do the basics.
- Always be in control when you are bouncing on the trampoline. A controlled jump is when you land at the same spot that you took off from. If at any time you feel out of control, try to stop your bouncing.
- Wear clothing free of drawstrings, hooks, loops, or anything that could get caught while using the trampoline/enclosure and result in entanglement or strangulation, or both.
- Do not attach anything to the barrier that is not a manufacturer approved accessory or part of the enclosure system.
- Stop bounce by flexing knees as feet come in contact with the bed.
- For equipment information, contact the manufacturer.
- For skill training information, contact a trainer certification organization.
- Read the instructions before use.
- Bounce in the center of the bed.
- Do not jump from other objects, building, or surfaces, onto the trampoline, or into or over the trampolines enclosure.

The Little Tikes Co. 650635C-1

⚠ WARNING • ATTENTION • ADVERTENCIA
ACHTUNG • WAARSCHUWING • OSTRZEŻENIE:

DO NOT ATTEMPT OR ALLOW SOMERSAULTS. LANDING ON THE HEAD OR NECK CAN CAUSE SERIOUS INJURY, PARALYSIS, OR DEATH. EVEN WHEN LANDING IN THE MIDDLE OF THE BED, NECKS ARE AT RISK OF INJURY. NEVER LAND ON THE HEAD OR NECK. ALWAYS LAND IN THE MIDDLE OF THE BED.

NE VERPOEGEN OF TOEGEGEN. NIET VERPOEGEN OF TOEGEGEN. NIET VERPOEGEN OF TOEGEGEN. NIET VERPOEGEN OF TOEGEGEN. NIET VERPOEGEN OF TOEGEGEN.

DO NOT ALLOW MORE THAN ONE PERSON ON THE TRAMPOLINE. USE BY MORE THAN ONE PERSON AT THE SAME TIME INCREASES THE CHANCE OF INJURY.

NIET MEER DAN EEN PERSOON OP DE TRAMPOLINE. GEBRUIK VAN MEER DAN EEN PERSOON OP DE TRAMPOLINE VERHOOGT DE WAARSCHUWING VAN LETSEL.

USE TRAMPOLINE ONLY WITH MATURE, KNOWLEDGEABLE SUPERVISION. UTILISEZ LE TRAMPOLINE SEULEMENT SOUS LA SURVEILLANCE D'UN ADULTE COMPÉTENT. DAS TRAMPOLIN DÜRF NUR UNTER AUFSICHT VON SACHKUNDEGEBEN ERWACHSENEN BENUTZT WERDEN. GEBRUIK DE TRAMPOLINE ALLEEN ONDER TOEZICHT VAN EEN ERVAREN VOLWASSEN. UZTYBIK TRAMPOLINY WYŁĄCZNIE POD NADZOREM OSOBY ODPowiedzialnej! POBRANIE/CIĘŻAR WYWIĘŻENIE O PRÓBOWANIE.

⚠ WARNING

THIS EQUIPMENT IS FOR USE BY ONE PERSON AT A TIME. REFER TO MANUFACTURER INSTRUCTIONS

DO NOT ALLOW ACCESS UNDERNEATH THE TRAMPOLINE. DO NOT USE IF WET

THE MAXIMUM USER WEIGHT FOR THIS TRAMPOLINE IS 105 lbs (47.63 kgs).

- DO NOT ATTEMPT OR ALLOW SOMERSAULTS. LANDING ON THE HEAD OR NECK CAN CAUSE SERIOUS INJURY, PARALYSIS, OR DEATH, EVEN WHEN LANDING IN THE MIDDLE OF THE BED.
- DO NOT ALLOW MORE THAN ONE PERSON ON THE TRAMPOLINE. USE BY MORE THAN ONE PERSON AT THE SAME TIME INCREASES THE CHANCE OF INJURY.
- USE TRAMPOLINE ONLY WITH MATURE, KNOWLEDGEABLE SUPERVISION.

650635C

IMPORTANT INFORMATION - LESSONS

TIPS TO REDUCE THE RISK OF ACCIDENTS

All jumpers need to be supervised, regardless of skill level or age.

Jumpers role in accident prevention:

The key here is to stay in control of your jumps. DO NOT move onto more complicated, more difficult maneuvers until you have mastered the basic, fundamental bounce. Education is also key to safety and very important. Read, understand, and practice all safety precautions and warnings prior to using the trampoline. A controlled jump is when you land and take off from the same location. For additional safety tips and instructions, contact a certified trampoline instructor.

Supervisor's or owner's role in accident prevention:

Supervisor's need to understand and enforce all safety rules and guidelines. It is the responsibility of the supervisor to provide knowledgeable advice and guidance to all jumpers on the trampoline. If supervision is unavailable or inadequate, the trampoline should be stored in a secure place, disassembled to prevent unauthorized use, or covered with a heavy tarp that can be locked or secured with locks or chains.

ADDITIONAL TRAMPOLINE SAFETY INSTRUCTIONS JUMPERS

- Do not use the trampoline if you have consumed alcohol or drugs.
- Remove all hard and sharp objects from person before using trampoline and trampoline enclosure.
- You Should climb on and off in a controlled and careful manner. Never jump on or off the trampoline and never use the trampoline as a device to bounce onto or into another object.
- Always learn the basic bounce and master each type of bounce before trying more difficult types of bounces. Review the Basic Trampoline Bounces Section to learn how to do the basics.
- To Stop your bounce, flex your knees when you land on the mat with your feet.
- Always be in control when you are bouncing on the trampoline. A controlled jump is when you land at the same spot that you took off from. If at any time you feel out of control, try to stop your bouncing.
- Do not jump or bounce for prolonged periods of time or too high for a number of jumps.
- Keep your eyes on the mat to maintain control. If you do not, you could lose balance or control.
- Never have more than one person on the trampoline at any one time
- Always have a supervisor watching you when you are on the trampoline

SUPERVISORS

- Educate yourself with the basic jumps and safety rules. To prevent and reduce the risk of injuries, enforce all safety rules and ensure that new jumpers learn the basic bounces before trying more difficult and advanced jumps.
- All jumpers need to be supervised, regardless of skill level or age.
- Never use the trampoline when it is wet, damaged, dirty, or worn out. The trampoline should be inspected before any jumpers start bouncing on it.
- Keep all objects that could interfere with the jumper away from the trampoline. Be aware of what is overhead, underneath, and around the trampoline.
- To prevent unsupervised and unauthorized use, the trampoline and trampoline enclosure should be secured when not in use.

LESSONS

The following lessons are suggested in order to learn basic steps and bounces before moving onto more difficult, complicated bounces. Before actually getting on and using the trampoline, you should read and understand all safety instructions. A complete discussion and demonstration of body mechanics and trampoline guidelines should occur between the supervisor and student as well.

Lesson 1

- Mounting and Dismounting - Demonstration of proper techniques.
- The Basic Bounce-Demonstration and practice.
- Braking (Check the Bounce-Demonstration) and practice. Learn to brake on command.
- Hands and knees-demonstration and practice. Stress should be on four-point landing and alignment.

Lesson 2

- Review and practice of techniques learned in Lesson 1.
- Knee Bounce-Demonstration and practice. Learn the basic, down to knee and back up before trying half twist to the left and right.
- Seat Bounce-Demonstration and practice. Learn the basic, seat bounce then add a knee bounce, hands and knees; repeat.

Lesson 3

- Review and practice skills and techniques learned in previous lessons
- Front Drop-To avoid mat burns and teach the front bounce position. All students should be requested to assume the prone position (face down on the ground) while the instructor checks for faulty positions that could cause injury.
- Start with a hands and knees bounce and then extend body into prone position, and on the mat and return to feet.
- Practice Routine Hands and knees Bounce, Front Bounce, back to feet, Seat Bounce, back to feet, Seat Bounce, back to feet.

Lesson 4

- Review and practice skills and techniques learned in previous lessons.
- Half-turn
 - Start from front drop position and as you make contact with mat, push off with arms in either the right or left direction and turn head and shoulders in same direction.
 - During turn, be sure to keep back parallel to mat and head up.
 - After completing turn, land in front drop position.

After completing this lesson, the student now has a basic foundation of trampoline bounces. Jumpers should be encouraged to try and develop their own routines with the emphasis on control and form.

ASSEMBLY INSTRUCTIONS

STEP 5 - Spring Loading Instructions (cont.)

Attach a spring at every 3 holes and corresponding triangle-rings. For even distribution of tension and ease of assembly, springs should be placed on opposite side of the mat/frame...i.e. 3 then 21, 33 then 15, etc. In addition to the previously installed springs, you should have springs at 3, 9, 15, 21, 27 and 33 as shown.

CAUTION

If you notice that you have miscounted a hole and triangle-ring connection, recount and remove or attach any springs required to maintain the count of springs.

Then attach the remaining 18 springs by using the same theory of counting equal holes as shown.

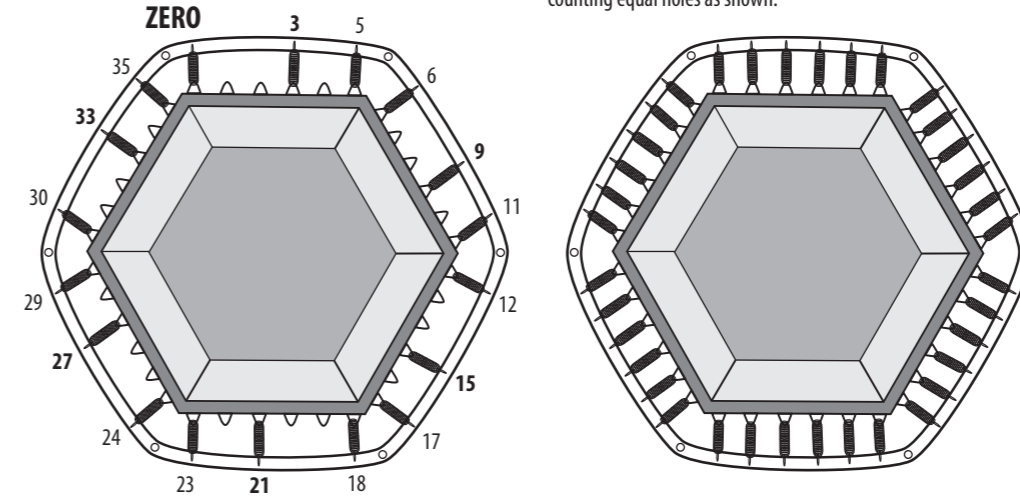

STEP 6 - Enclosure Frame Assembly



Insert a foam tube (T) over each straight frame tube (I). All straight frame tubes must have foam around them.

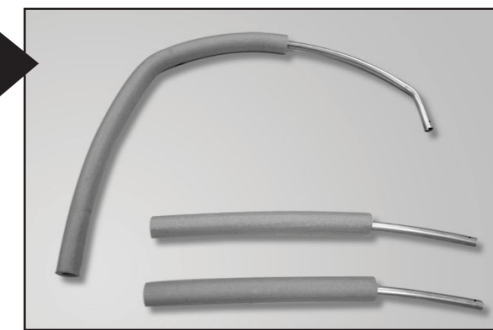

Insert a foam tube (S) and (T) over each horizontal tube (H) and curved frame tube (J).



Secure the tubes of the arch together using a self locking screw (M). Tighten with screwdriver (W).



Make sure curve frame tubes with horizontal tube (H) tilt inward.

Repeat assembly for the other 2 arch frames.

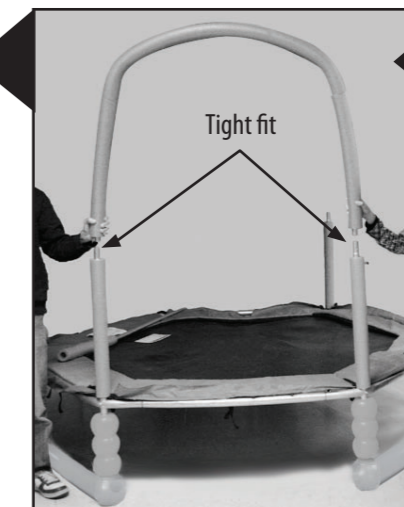

Connect curve frame tubes (J) into the straight frame tubes (I).



Assemble horizontal tube with foam (H) with two curved frame tubes with foam (J).

ASSEMBLY INSTRUCTIONS

STEP 3 - Complete for all 6 corner top rails

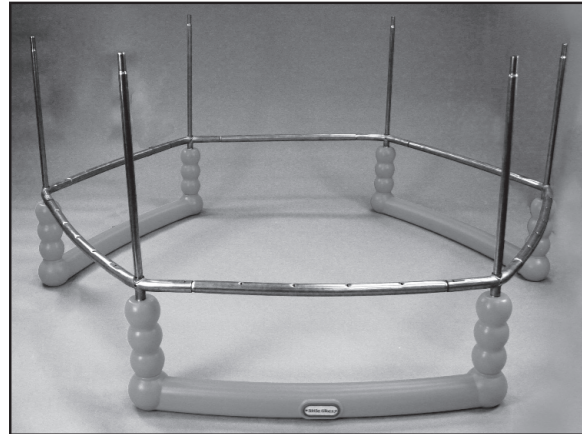

Insert straight frame tubes into the socket of the corner top rails (E).

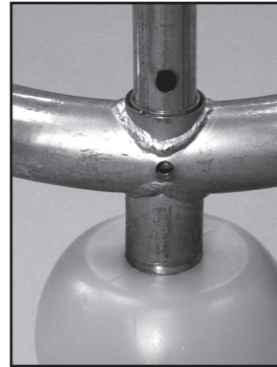

Make sure the hole on the straight frame tube (I) matches with the hole in the socket on corner top rail (E). Slightly rotate the straight frame tube to align holes if needed.

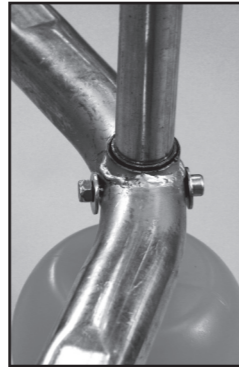

Insert bolt (L) through an arc washer (O) then through front opening hole in straight frame tube. Secure back with an arc washer (O), a spring washer (P) and cap nut (N). Tighten bolt assembly using wrench (Q) to hold cap nut in place while tightening bolt with screwdriver (W).

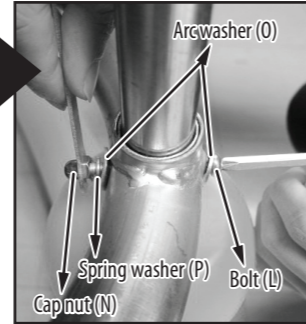

STEP 4 - Trampoline Mat Assembly

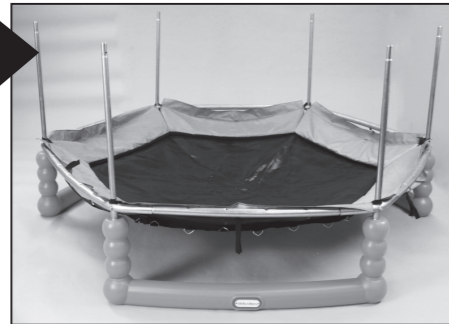
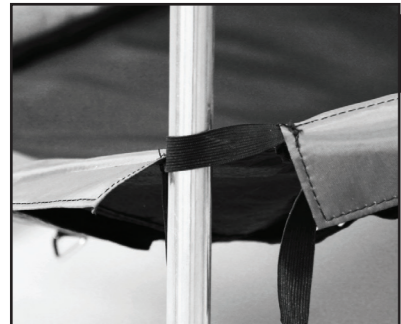

Layout trampoline mat with safety pad (A) flat. Place trampoline mat over assembled frame. Triangle rings should be underneath safety pad. Loop elastic on each corner over each of the straight frame tubes. Slide elastic down to the base as shown.

STEP 5 - Spring Loading Instructions

There are a total of 36 triangle-rings sewn on the mat and 36 holes on the top rail frame.

None are numbered so please follow the instructions carefully to ensure proper installation. Now select an arbitrary point on the top rail frame, call it ZERO.

Attach springs at the corner top rails as shown in diagram below. For even distribution of tension and ease of assembly, springs should be placed on opposite side of the mat/frame...i.e. 5,6 then 23,24. Complete spring installation for numbers below. You should now have the following 12 springs installed: ZERO, 5, 6, 11, 12, 17, 18, 23, 24, 29, 30 and 35.

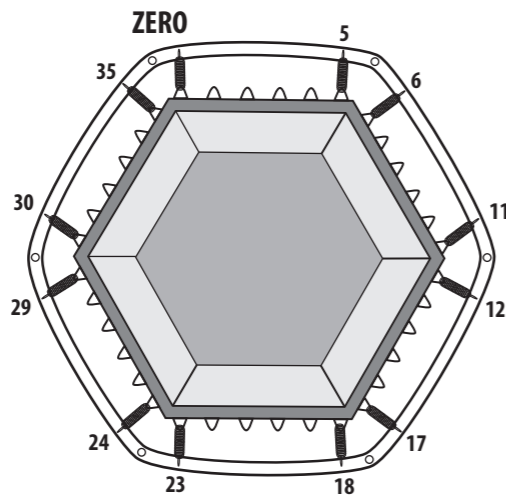
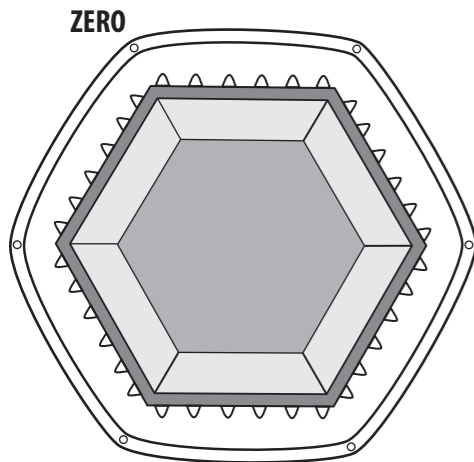

⚠️ SPRING LOADING CAUTIONS

- Make sure to flip up the safety pad for ease of installation of springs.
- Two adults are required in this assemble step.
- CAREFUL - When attaching the springs, please do not put your hands, legs, or body close to the connector points.
- Wear heavy duty work gloves to protect your hands.
- For ease of assembly, use special spring loading tool (R).

Attaching Spring



Attach the R-hook galvanized spring (K) with "R" hook end to the triangle-ring on the mat as shown. Holding the spring at 45 degrees in relation to the mat surface will be much easier to install into triangle-ring. Hold the spring loading tool underhand and pull spring hook towards the point on the top rail frame. Drop hook into frame hole until it latches on completely and tap it down if hook is not completely in the hole.

BASIC TRAMPOLINE BOUNCES

The Basic Bounce

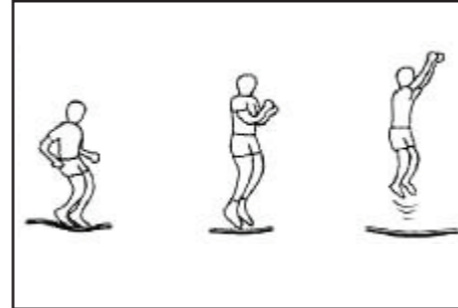

1. Start from standing position, feet shoulder width apart and with head up and eyes on mat.
2. Swing arms forward and up, in a circular motion.
3. Bring feet together while in mid-air and point downward.
4. Keep feet shoulder width apart when landing on mat.

Knee Bounce

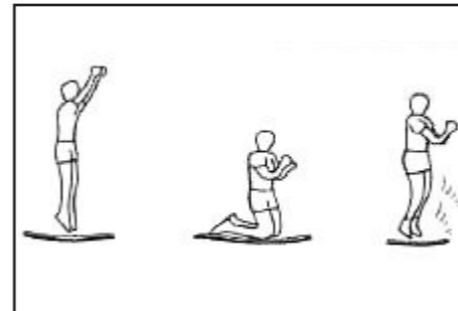

1. Start with basic bounce and keep it low.
2. Land on knees keeping back straight, body erect and use your arms to maintain balance.
3. Bounce back to basic bounce position by swinging arms up.

Seat Bounce

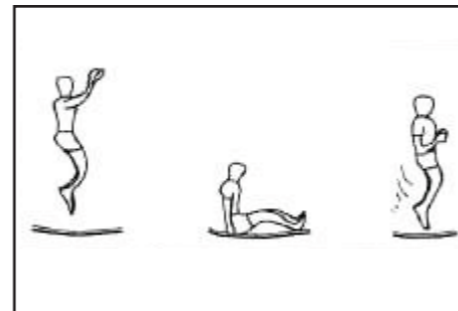

1. Start with basic bounce.
2. Land in a flat sitting position.
3. Place hands on mat beside hips, do not lock your elbows.
4. Return to erect position by pushing with hands.

Front Bounce

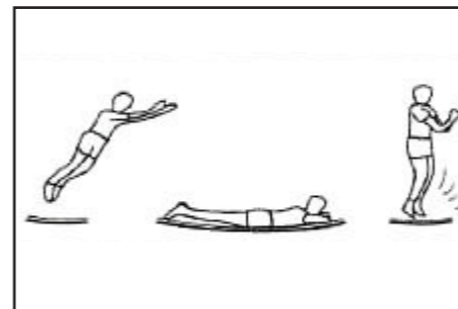

1. Start with a low bounce.
2. Land in prone (face down) position and keep hand and arms extended forward on mat.
3. Push off the mat with arms to return to standing position.

180° Degree Bounce

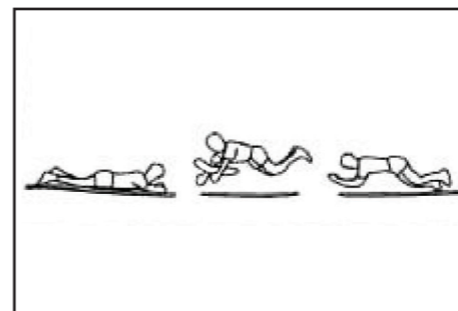

1. Start with front bounce position.
2. Push off with left or right hands and arms (depending on which way you wish to turn).
3. Maintain head and shoulders in the same direction and keep back parallel to mat and head up.
4. Land in prone position and return to standing position by pushing up with hands and arms.

- Jumpers should wear T-shirt, shorts or sweats, and regulation gymnastics shoes, heavy socks, or be barefoot. If you are just beginning, you may want to wear long sleeve shirts and pants to protect against scrapes and abrasions until you master correct landing positions and form. Do not wear hard sole shoes, such as tennis shoes on the trampoline, as this will cause excessive wear on the mat material.
- You should always mount and dismount properly to avoid injury.
- Do not bounce recklessly on the trampoline since this will increase your chances of getting injured. The key to safety and having fun on the trampoline is control and mastering the various bounces. Never try to out-bounce another bouncer in terms of height! Never use the trampoline alone without supervision.

- Not recommended for use by children under 5 or over 10 years of age.

Mounting and Dismounting: Be very careful when getting on and the trampoline. DO NOT mount the trampoline by grabbing the safety pad, stepping onto the springs, or by jumping onto the mat of the trampoline from any object (i.e. a deck, roof, or ladder). This will increase your chances of getting injured! DO NOT dismount by jumping off the trampoline and landing on the ground, regardless of the makeup of the ground. If small children are playing on the trampoline, they may need help dismounting.

Use of Alcohol and Drugs: DO NOT consume any alcohol or drugs when using this trampoline! This will increase your chances of getting injured since these foreign substances impair your judgment, reaction time, and overall physical coordination.

Multiple Jumpers: Multiple jumpers (more than one person on the trampoline at any one time) increase the chance of getting injured. Injuries could occur when you fly off the trampoline, lose control, collide with the other jumper(s), or land on the springs. Generally, the lightest person on the trampoline will get injured. **No more than one person at a time on the trampoline.**

Striking the Frame or Springs: When playing on the trampoline, STAY in the center of the mat. This will reduce your risk of getting injured by landing on the frame or springs. Always keep the safety pad covering the frame of the trampoline. DO NOT jump or step onto the safety pad directly since it was not intended to support the weight of a person.

Loss of Control: DO NOT try maneuvers, or any maneuvers until you have mastered the previous maneuver, or if you are just learning how to jump on a trampoline. If you do, you will increase your risk of getting injured by landing on the frame, springs, or off the trampoline completely because you might lose control of your jump. A controlled jump is considered landing on the same spot that you took off. If you do lose control when you are jumping on the trampoline, bend your knees sharply when you land and this will allow you to regain control and stop your jump.

Somersaults (Flips): DO NOT PERFORM somersaults of any type (backwards or forwards) on this trampoline. If you make a mistake when trying to perform a somersault, you could land on your head or neck. This will increase your chances of getting your neck or back broken, which could result in death or paralysis.

Foreign Objects: DO NOT use the trampoline if there are pets, other people, or any objects underneath the trampoline. This will increase the chances of an injury occurring. DO NOT hold any foreign objects in your hand and DO NOT place any objects on the trampoline while anyone is playing on it. Please be aware of what is overhead when you are playing on the trampoline. Tree limbs, wires, or other objects located over the trampoline will increase your chances of getting injured.













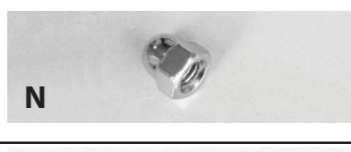







Poor Maintenance of Trampoline: A trampoline in poor condition will increase your risk of getting injured. Please inspect the trampoline before each use for bent steel tubes, torn mat, loose or broken springs, and overall stability of the trampoline.

Weather Conditions: Please be aware of the weather conditions when using the trampoline. If the mat of the trampoline is wet, the jumper could slip and injure him or herself. If it is too windy, jumpers could lose control. Use the trampoline only when the jumping mat is clean and dry. A wet jumping mat is extremely slick and prevents a stable landing.

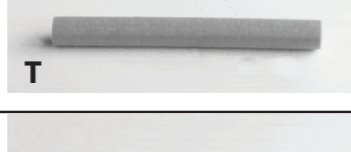
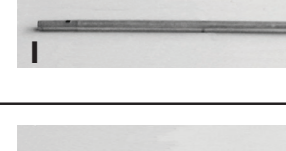
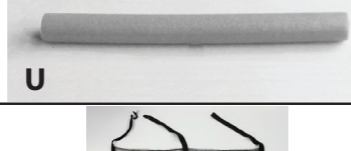
When the trampoline is not in use, store it in a secure place so that unsupervised children cannot play on the trampoline.

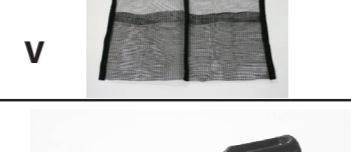
Parts List

Please refer to this page for parts descriptions and letters. The assembly steps use these descriptions and letters as reference for your convenience. Make sure that you have all parts listed.

 A	Qty - 1 Trampoline Mat stitched with Triangle-rings and safety pad	 M	Qty - 6 Self-locking screw
 B	Qty - 1 Enclosure Netting	 N	Qty - 6 Cap Nut
 C	Qty - 3 Plastic Horizontal Leg Base	 O	Qty - 12 Arc Washer
 D	Qty - 6 Plastic Vertical Leg Extension	 P	Qty - 6 Spring Washer
 E	Qty - 6 Corner Top Rail with Socket	 Q	Qty - 1 Wrench
 F	Qty - 6 Vertical Leg Extension (with "Button Cap")	 R	Qty - 1 Spring Loading Tool with Allen wrench and screwdriver
 G	Qty - 6 Top Rail	 S	Qty - 3 Foam Tube for Horizontal Tube
 H	Qty - 3 Horizontal Tube	 T	Qty - 6 Foam Tube for Straight Frame Tube
 I	Qty - 6 Straight Frame Tube	 U	Qty - 6 Foam Tube for Curved Frame Tube
 J	Qty - 6 Curved Frame Tube	 V	Qty - 1 Shoe Bag
 K	Qty - 36 Galvanized Springs	 W	Qty - 1 Screwdriver
 L	Qty - 6 Bolt		

**Remember to use gloves during assembly to avoid pinching.
At least 2 people are required to assemble the trampoline.**

Adult assembly required

Tools required



Safety glasses should be worn during the assembly of trampoline.

ASSEMBLY INSTRUCTIONS

STEP 1 - Support Assembly

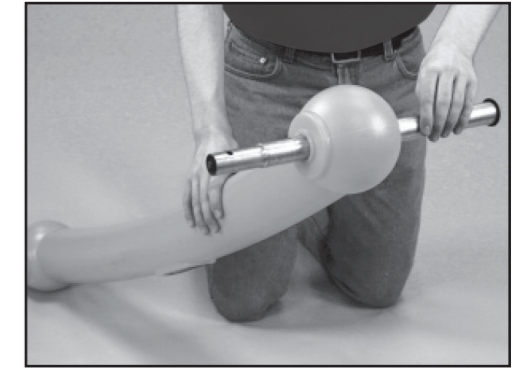

Insert a vertical leg extension (F) through hole on each end of a plastic horizontal leg base (C). Repeat for remaining 2 plastic horizontal leg bases (C).

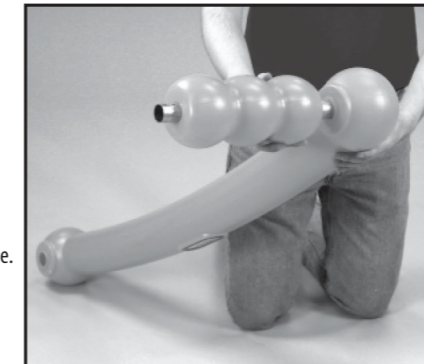

Insert a plastic vertical leg extension (D) over each vertical leg extension (F). Repeat for remaining 5 vertical leg extensions (F).

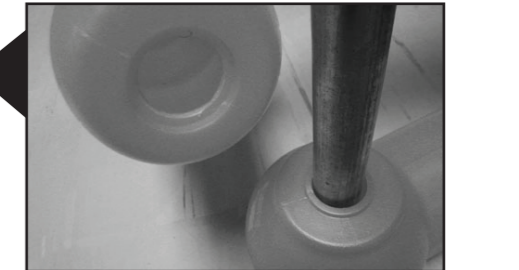

Recess on plastic vertical leg extension (D) must fit into leg base (C) as shown.

STEP 2 - Frame Layout

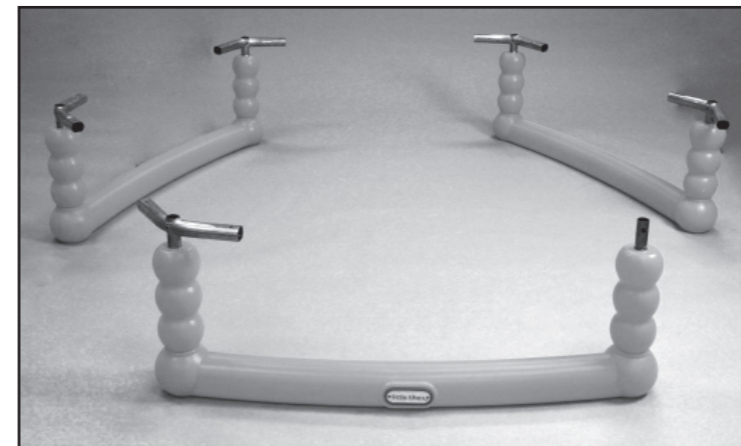

Layout 3 sets Support Assemblies (pre-assembled in STEP 1) as shown above.

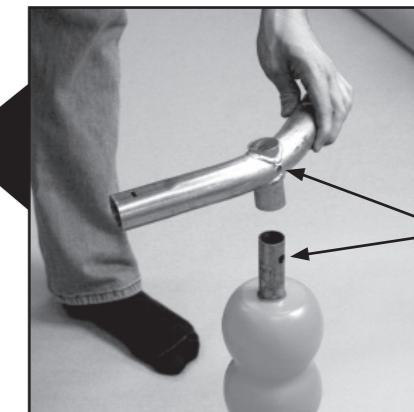

Insert the corner top rail with socket (E) to the Support Assembly as shown. Repeat this for all corner top rails with sockets (E).

IMPORTANT: hole in corner top rail should align to the hole in vertical leg extension.

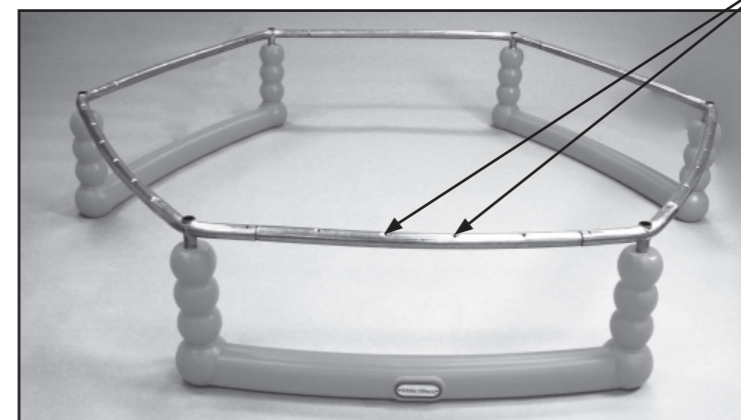

There are total of 12 pieces of tubing and 3 sets Support Assemblies (pre-assembled in STEP 1) that are needed to assemble the frame.

IMPORTANT: be sure the curve side of the plastic horizontal leg bases (C) and the curve of the top rails (G) are facing outward.

Holes must face up.

Assemble top rail (G) into each end of corner top rail with socket (E). To connect parts, simply slide the section of tubing that is smaller on one end into the adjacent section that has a larger opening as shown.

