

EN/CN-A01

Guider 3 引领者 3

用户使用手册

USER GUIDE

中文P26

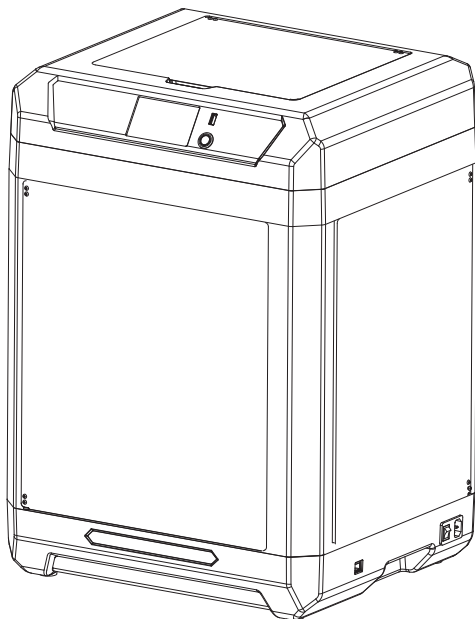

This guide is only applicable to FLASHFORGE Guider 3 3D printer

本手册仅适用于闪铸科技引领者 3打印机

CONTENT

Notice

Equipment Parameter

1. Equipment Introduction _____ 05

- 1.1 - Guider 3 Introduction 05
- 1.2 - Packing List 06

2. Preparation Before Printing _____ 07

- 2.1 - Power Connection 07
- 2.2 - Filament Loading 08
- 2.3 - Equipment Calibration 10
- 2.4 - Network Connection 11
 - 2.4.1 - Wired Network Connection 11
 - 2.4.2 - Wireless Network Connection 11

3. Software Installation _____ 12

4. First Printing _____ 12

- 4.1 - File Transfer: Wi-Fi Transfer 12
- 4.2 - Printing From a USB Flash Drive 12
- 4.3 - Cloud Printing 13
- 4.4 - Camera Connection 14
- 4.5 - Model Removal After Finishing Printing 14

5. Equipment Operation Interface Introduction — 15

- 5.1 - Printing Screen 15
- 5.2 - Filament Screen 16
- 5.3 - Preheating Screen 17
- 5.4 - Tools Screen 17
- 5.5 - Settings Screen 18

6. Maintenance _____ 19

- 6.1 - Maintenance Screen 19
- 6.2 - Extruder Maintenance 19
- 6.3 - Platform Replacement 20
 - 6.3.1 - Glass Platform Replacement 20
 - 6.3.2 - Flexible Steel Plate Platform Replacement 21
- 6.4 - Platform Flatness Calibration 22

7. Q&A _____ 23

8. Help and Support _____ 25

NOTICE

SAFETY NOTICE: PLEASE CAREFULLY READ AND STRICTLY FOLLOW ALL THE SAFETY WARNINGS AND NOTICES BELOW ALL THE TIME.

Note: Every 3D printer has undergone printing tests before leaving the factory. If there are some filament residues in the extruder of the equipment or some slight scratches on the build plate, it is normal and will not affect its use.

WORK ENVIRONMENT SAFETY

- ◆ Please keep the work table of the equipment clean and tidy.
- ◆ Please ensure that the equipment is away from combustible gases, liquids and dust when it is in operation. The high temperature generated by equipment operation may react with combustible gases, liquids, and airborne dust, thus causing fire.
- ◆ Children and untrained personnel are not allowed to operate the equipment alone.

ELECTRICAL SAFETY

- ◆ Be sure to ground the equipment. Do not modify the plug of the equipment. Not grounded equipment/improperly grounded equipment/modified plug will inevitably increase the risk of electric leakage.
- ◆ Do not expose the equipment to damp or hot-sun environment. Humidity will increase the risk of electric leakage. Exposure to sunlight will accelerate the aging of plastic parts.
- ◆ Make sure to only use the power cord provided by Flashforge.
- ◆ Do not use the equipment during a thunderstorm.
- ◆ Please shut down the equipment and unplug it if it is not in use for a long time.

PERSONAL SAFETY

- ◆ Do not touch the extruder, build plate, etc., during printing.
- ◆ Do not touch the extruder and build plate when finishing printing in order to avoid high temperature burns or mechanical damage.
- ◆ Do not wear scarves, masks, gloves, jewelry ornaments or other objects that can easily get tangled into the equipment when operating it.
- ◆ Do not operate the equipment while you are tired or under the influence of drugs, alcohol or medication.

CAUTIONS

- ◆ Keep the inside of the equipment clean and tidy. Do not drop metal objects into the sliding chute at the bottom of the build plate.
- ◆ Please clean up the filament debris in time. It is recommended to operate this outside the equipment.

- ◆ Any modification of the equipment by yourself will result in the situation that you will not be entitled to warranty rights anymore.

Please keep the distance between the extruder and build plate for at least 50mm during filament loading. Too-close distance may cause nozzle clogging.

- ◆ Please operate the equipment in a well-ventilated environment.
- ◆ Do not use the equipment for illegal activities.
- ◆ Do not use the equipment to make any food storage products.
- ◆ Do not put the printed model into your mouth.

EQUIPMENT ENVIRONMENT REQUIREMENTS

- ◆ The room temperature should be between 15°C and 30°C.
- ◆ The humidity should be between 20RH% and 70RH%.

EQUIPMENT PLACEMENT REQUIREMENTS

- ◆ The equipment must be placed in a dry and ventilated environment. A distance of at least 30cm must be reserved at the left side and rear side of the equipment, and a distance of at least 45cm must be reserved at the right side and front side of the equipment. The storage temperature should be between 0°C and 40°C.

COMPATIBLE FILAMENT REQUIREMENTS

- ◆ When using the equipment, it is recommended to use Flashforge's filaments. If non-Flashforge filaments are used, there will be certain differences in material characteristics, and thus printing parameters may need to be adjusted.

FILAMENT STORAGE REQUIREMENTS

- ◆ Please store filaments in a dry and dust-free environment after unpacking. It is recommended to use the matching filament dry box for storage.

LEGAL STATEMENT

- ◆ The user has no right to make any modification to this user guide.
- ◆ Flashforge will not be responsible for any safety accidents caused by the disassembly or modification of the equipment by the customer. No one is allowed to modify or translate this guide without the permission of Flashforge. This guide is protected by copyright, and Flashforge reserves the right of the final interpretation of this guide.

- ◆ First Edition (August 2022)

Copyright © 2022 Zhejiang Flashforge 3D Technology Co., Ltd. All Rights Reserved.

Equipment Parameter

Equipment Name	Guider 3
Extruder Quantity	1
Printing Precision	± 0.15mm or 0.002 mm/mm [The larger values shall prevail]
Positioning Accuracy	X/Y-axis: 0.011mm Z-axis: 0.0025mm
Layer Thickness	0.05 ~ 0.4mm
Build Volume	300x250x340mm
Nozzle Diameter	Default 0.4mm [Optional 0.6/0.8]mm
Nozzle Type	Stainless steel nozzle
Printing Speed	10 ~ 250mm/s
Maximum Extruder Temperature	320°C
Maximum Platform Temperature	110°C
Supported Filament	ABS/PLA/PC/PA/HIPS/ASA/PETG/PA-CF/PLA-CF PETG-CF/PETG-GF
Power Supply	AC100-240V/DC 24V/20.8A, 500W
Slicing Software	FlashPrint
Input/Output File Format	Input: 3MF/STL/OBJ/FPP/BMP/PNG/JPG/JPEG; Output: GX/G/gcode
Connectivity	USB flash drive/Ethernet/Wi-Fi
Operating Temperature	15 ~ 30°C
Compatible Operating System	Windows XP/Vista/7/8/10、Mac OS
Compatible Slicing Software	Slic3r, Cura [Need setting]
Smart Touch Screen	4.3-inch
Build Plate	Flexible steel plate platform/Glass platform
Net Weight	27kg
Equipment Dimensions	496[L] x 436[W] x 696[H] mm
Required Space for Installation	≥590*543*758mm





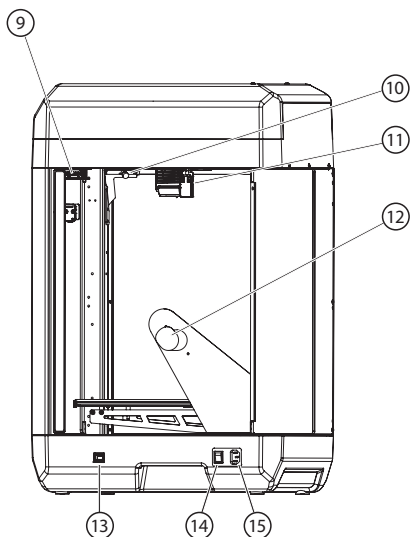
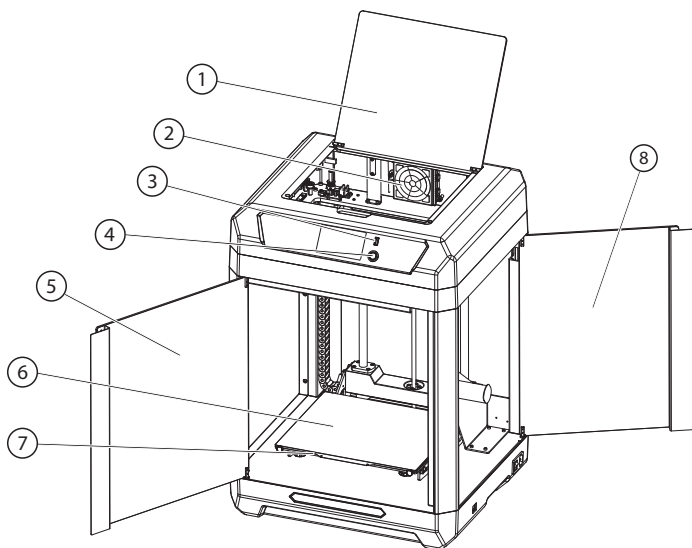



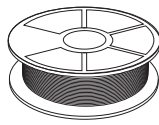

1. Equipment Introduction

Guider 3 Introduction

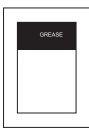

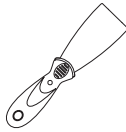
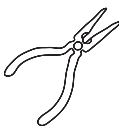
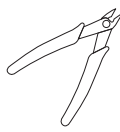
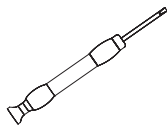
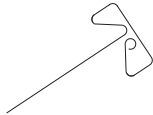
- 1. Upper Cover 2. Air Filter
- 3. USB Port 4. Screen Switch
- 5. Front Door 6. Flexible Steel Plate
- 7. Platform Plate 8. Filament Chamber Door
- 9. Chamber Light 10. Camera 11. Extruder
- 12. Filament Spool Holder
- 13. Network Cable Port 14. Power Switch
- 15. Power Port

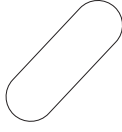
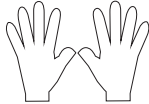
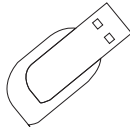
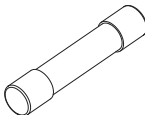
1.2 Packing List

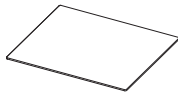
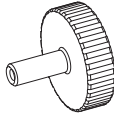
			
3D Printer	3D Printing Filament	Power Cord	After-sales Service Card
			
User Guide	Lubricating Grease x 2	Cleaning Brush	Glue
			
Scraper	Nipper Pliers	Diagonal Pliers	Straight Screwdriver
			
Unclogging Pin Tool	Allen Wrench Set	Elbow Tweezers	Leveling Card
			
Heat Insulating Gloves	USB Flash Drive	Fuse x 2	Thermally Conductive Adhesive
			
Glass Platform	Hand Screw Bolt x 2		

2. Preparation Before Printing

2.1 Power Connection

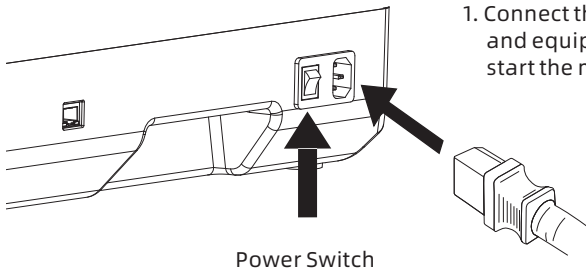

1. Connect the power cord to the socket and equipment and press the switch to start the machine.

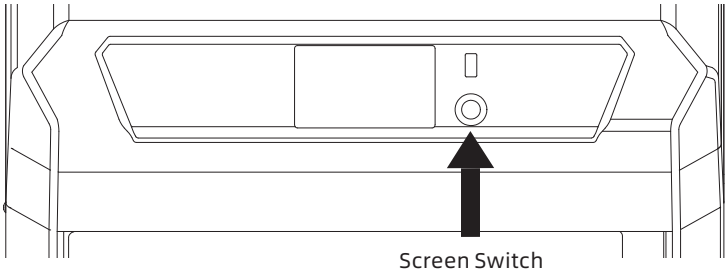

2. Turn on the screen switch and the screen light is on.

2.2 Filament Loading

1. Open the filament chamber door, hang the filament on the filament spool holder, and pass the filament clockwise through the corresponding filament sensor at the upper left of the chamber inside until the filament is visible from the other end of the filament guide tube;

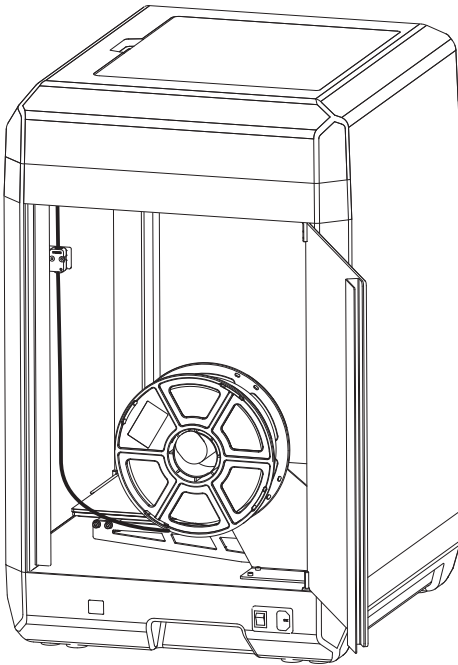

2. Press the filament feeding handle on the extruder and insert the filament into the extruder;

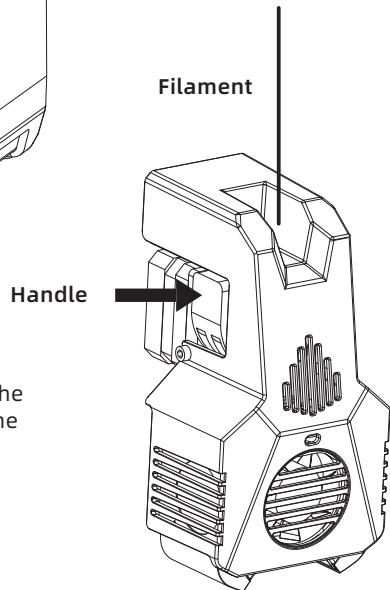

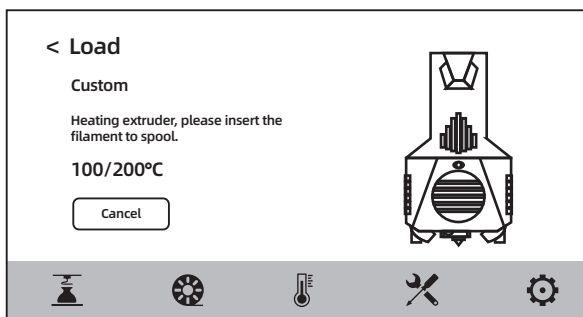
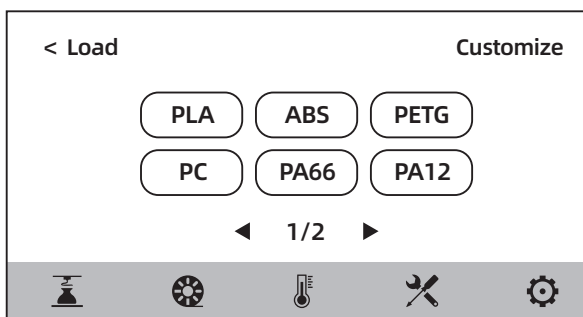
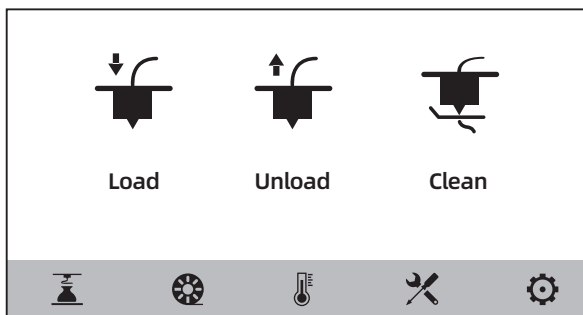

3. Click the [] - [Load] on the screen, select the corresponding filament for the extruder, start filament feeding, and operate following the prompts on the screen.

2.3 Equipment Calibration

The equipment includes the following leveling and calibration operations: Z-Axis Calibration, Sensor Calibration, Assist Calibration [complete mode, simplified mode].

The equipment has been leveled and calibrated before leaving the factory, so it is generally unnecessary to perform calibration again. However, the leveling plane may be damaged due to the vibration generated during transportation. It is recommended to perform a Z-axis calibration and a sensor calibration before first use.

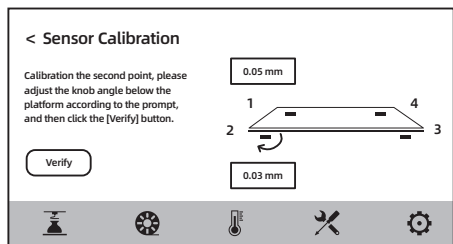
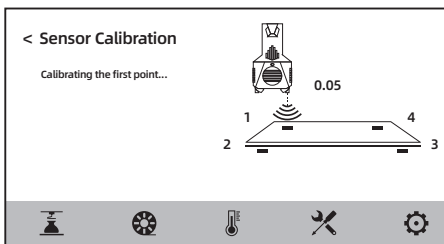
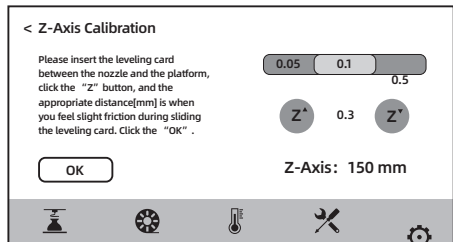
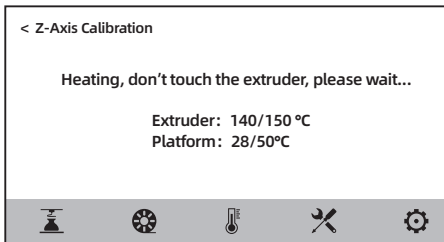
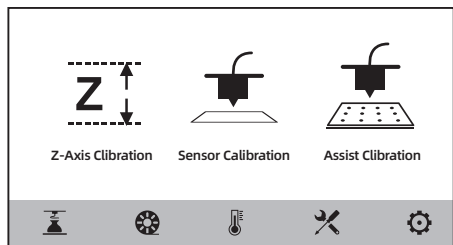
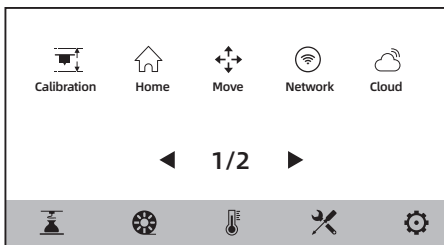

Please proceed in the following order: [you can refer to the operation video]

1. Click the [🔧] - [Calibration] on the touch screen;
2. Select the [Z-Axis Calibration];
3. Perform Z-axis calibration and operate following the prompts on the screen.
4. Select the [Sensor Calibration];
5. Perform sensor calibration and operate following the prompts on the screen.

2.4 Network Connection

2.4.1 Wired Network Connection

1. Plug the network cable into the network cable port on the back of the equipment.
2. Click the [🔧] - [Network] on the screen, select the wired network and turn on the wired network switch. If the [🖨️] icon appears at the upper right corner of the screen, it indicates that the network is successfully connected.

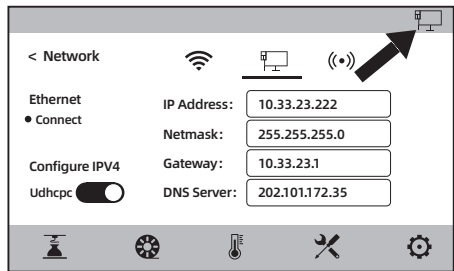
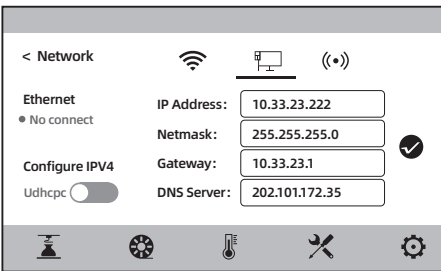

2.4.2 Wireless Network Connection

Please make sure Wi-Fi is installed before connecting to the wireless network, otherwise the wireless signal will be affected.

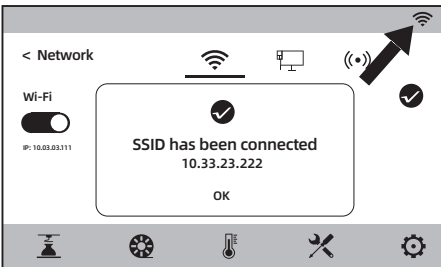
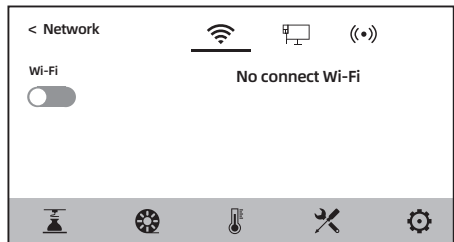
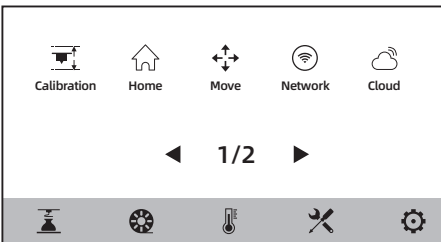

1. Click the [🔧] - [Network] on the touch screen, select the wireless network, and turn on the wireless network switch.
2. Click to connect to the corresponding wireless network and the corresponding prompt will appear on the screen after successful connection. If the [📶] icon appears at the upper right corner of the screen, it indicates that the network is successfully connected.

3. Software Installation

Method 1: Find the installation package of the FlashPrint software in the USB flash drive and select the corresponding system version for installation.

Method 2: Download the latest slicing software installation package from our official Chinese website [www.sz3dp.com] or our official English website [www.flashforge.com] for installation.

3D printing process:

Get the model file - Slice it with the slicing software - Transfer the file to the printer for printing.

4. First Printing

4.1 File Transfer: Wi-Fi Transfer

Import the file to FlashPrint for slicing, select the printer type as Guider 3 to connect to it [or by entering the IP address or by automatic scanning, while the IP address can be viewed in the [About] of the equipment]. After completing slicing, send the file directly to the printer for printing.

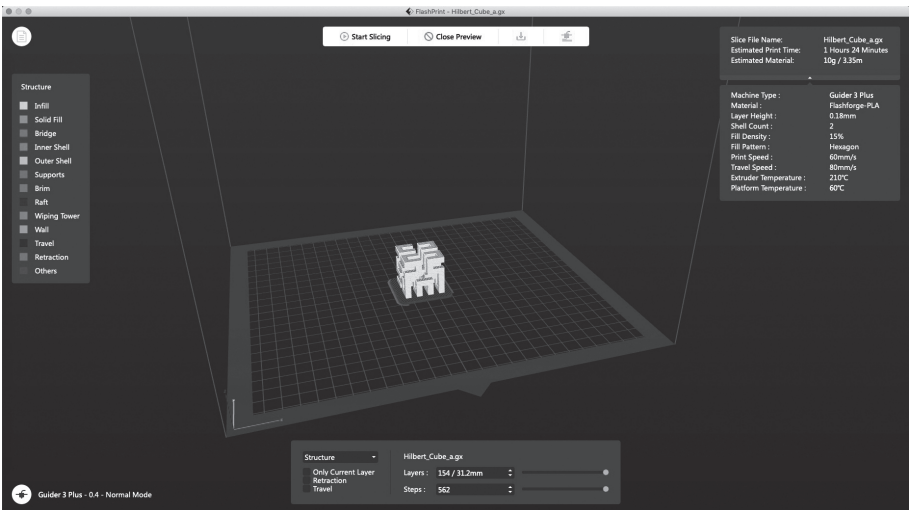

4.2 Printing From a USB Flash Drive

The equipment can also perform printing via a USB flash drive: save the sliced file to a USB flash drive, insert the USB flash drive into the equipment, and select the corresponding file to print.

4.3 Cloud Printing

Print via FlashCloud

1. Enter the FlashCloud website, register an account, and then log in after completing email activation. FlashCloud website: <https://cloud.sz3dp.com/>

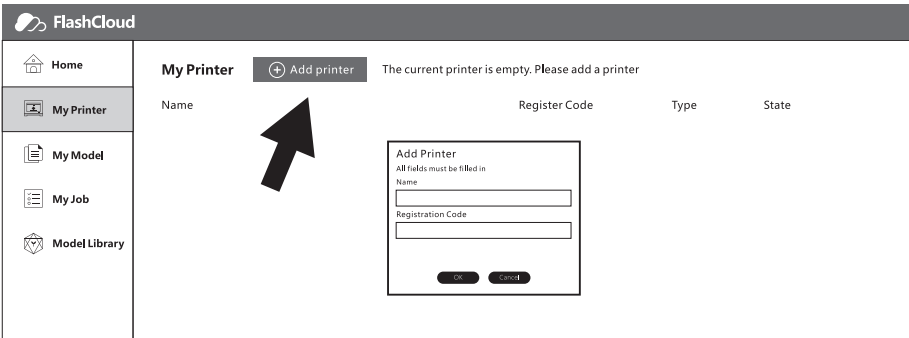

2. Click the [My Printer] - [Add Printer].
Fill in the registration code [cloud registration code] on the "Add Printer" page, and name the printer. After clicking the "OK", these information will appear on the FlashCloud interface of the printer.

Print via Polar Cloud

Enter the Polar Cloud website and register an account.
Polar Cloud website: <https://Polar 3d.com>

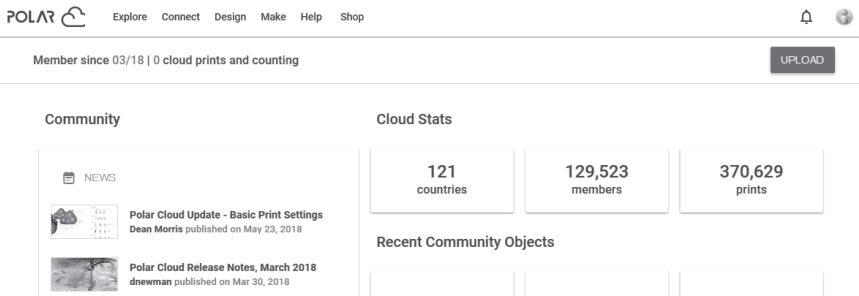

After logging in, click the avatar icon at the upper right corner, click [Settings], and click the PIN Code in the menu to query the PIN code. After connecting Guider 3 to the network, turn on the Polar Cloud switch and enter the account and PIN code.

4.4 Camera Connection

1. Please remove the camera cover before using the camera;
2. Turn on the camera switch;
3. After the equipment is connected to FlashPrint, the real-time videos and images can be viewed in the FlashPrint - [Multi-Machine Control].

4.5 Model Removal After Finishing Printing

WARNING

When removing the model from the build plate, please pay attention to the need to wait for the platform to cool down before operating. At this time, you can check the temperature icon on the status bar of the screen to confirm the platform temperature. The green icon indicates that the platform temperature is lower than 50°C, which is the appropriate state for safe operation. The matching gloves can be used when removing the model. In the meanwhile, pay careful attention to the high temperature of the equipment.

1. If the flexible steel plate platform is used, after printing is completed, directly lift the handle to remove the flexible steel plate and bend the platform plate to remove the model;
2. If the glass platform is used, after printing is completed, directly remove the model with a scraper.

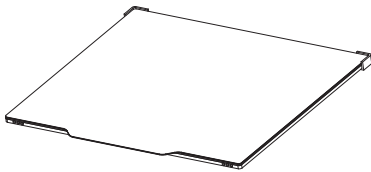

Flexible Steel Plate Platform

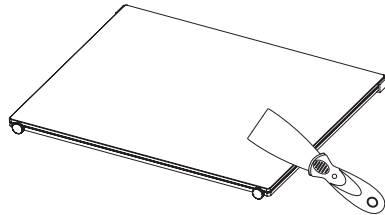

Glass Platform

When using the flexible steel plate platform, remove the model and put the platform plate back into the equipment. Operate as follows:

1. Hold the rear end of the flexible steel plate against the positioning blocks on the left and right edges of the platform (note that it is inserted into the inside of the positioning blocks);
2. The platform will be automatically adsorbed and installed on the platform.

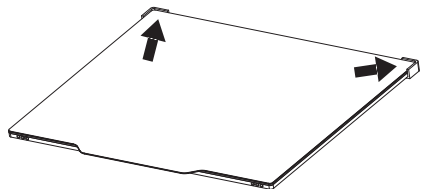

5. Equipment Operation Interface Introduction

ATTENTION

As the firmware will be upgraded from time to time, please refer to the actual display screens. The following is only a brief introduction of functions.

5.1 Printing Screen

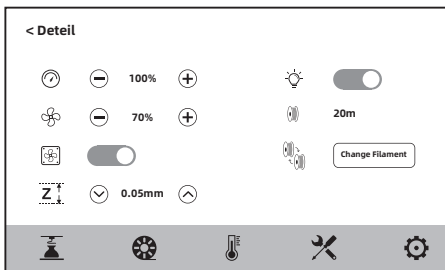
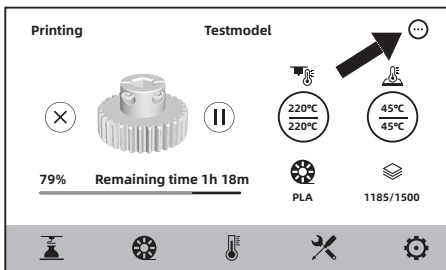
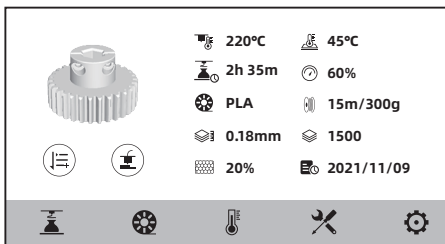
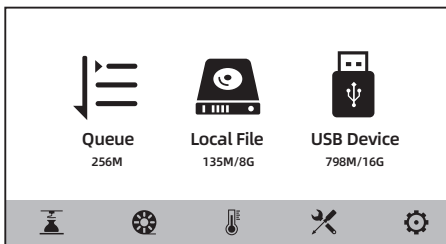

Some parameters can be adjusted during printing. Click the [⋮] icon to control the printing speed, fan and light.

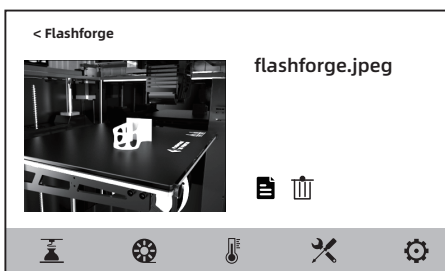
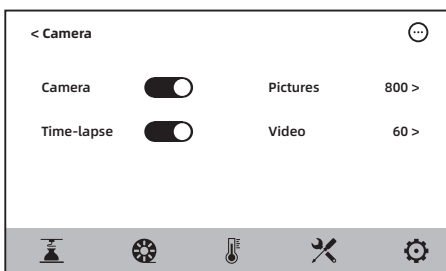

After turning on the camera, users can also store photos and videos of the printing process on the screen.

5.2 Filament Screen

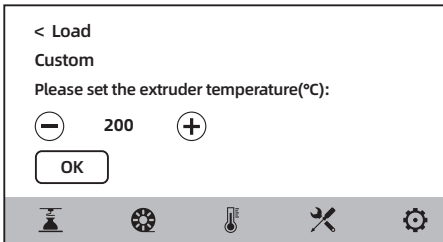
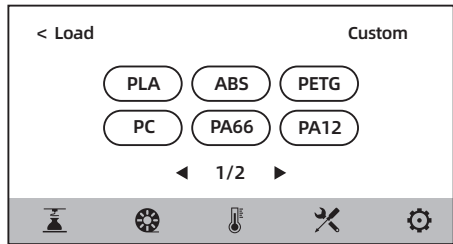
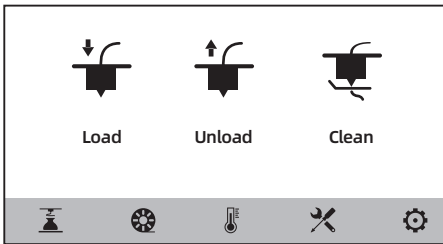

The filament screen includes:
[Load], [Unload] and [Clean].

During filament loading and unloading, users can select the corresponding filament to be installed on the screen. If the currently used filament is not listed on the screen, users can customize the filament and set the required temperature for filament loading.

Filament cleaning

When the filaments printed in the last two times are different, please carry out filament cleaning. In this way, it will avoid the situation that the carbonized filament leads to nozzle clogging or there is no filament extrusion due to different melting temperatures of different filaments. When switching from a filament of high printing temperature to a filament of low printing temperature, this operation must be performed; For example, when you need to switch to PLA filament after printing with PC filament, it is necessary to clean and remove the PC filament from the nozzle, so it is necessary to set the temperature required for melting PC filament until all the PC filament is extruded from the nozzle and there is no residue left in the nozzle.

5.3 Preheating Screen

The temperature of the extruder and platform can be set in advance as required on the preheating screen.

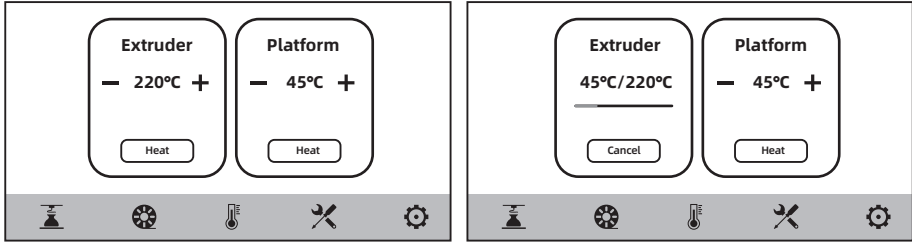

5.4 Tools Screen

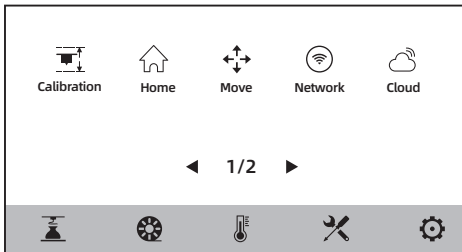

[Calibration]

Z-Axis Calibration, Sensor Calibration, Assist Calibration[complete mode, simplified mode].

[Home] Here you can make each axis of the equipment return to the zero position.

[Move] Here you can manually move the X, Y, Z-axis of the equipment.

[Network] Here you can connect to the wireless network, wired network and hot spot.

[Cloud] Here you can connect to the FlashCloud or Polar Cloud.

[Camera] Here you can turn on the camera and view the time-lapse video.

[About] Here displays the basic information about the equipment.

[Status] Here displays the running status of the equipment.

[Maintain] Here lists some maintenance items for users to check if users encounter any problems.

[Upgrade] Here is for firmware upgrade. Users can upgrade to the latest firmware of the equipment when connecting to wireless network.

5.5 Settings Screen

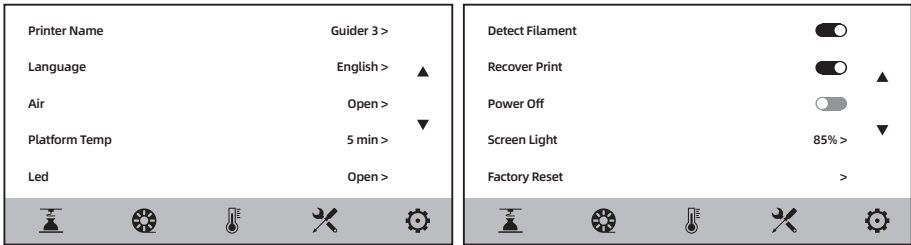

The several functions can be turned on or off on the settings screen.

- ◆ When the Air is turned on, the fan on the back of the equipment will be started; The front of the fan is equipped with HEPA filter cotton, which can filter the dust and odor generated during printing.
- ◆ When the Platform Temp is turned on, the platform insulation time before and after printing can be set. When in the transition state of removing the model, avoid increasing the time of reheating when the temperature drops. When this function is turned on, the platform remains the heating state when removing the model after finishing printing. Please pay attention to the high temperature and preventing burns and scalds.
- ◆ When the Led is turned on, the brightness of the light inside the chamber can be adjusted.
- ◆ When the Detect Filament is turned on, the equipment will stop printing when the filament runs out during printing.
- ◆ When the Recover Print is turned on, if the device encounters a power failure during printing, the device will automatically store the current printing position data. Then it will proceed the printing of the current model after the power is restored.
- ◆ When the Power Off is turned on, the equipment will automatically shut down after finishing model printing.

6. Maintenance

ATTENTION

As the firmware will be upgraded from time to time, please refer to the actual display screens. The following is only a brief introduction of functions.

6.1 Maintenance Screen

Users can click the [] - [Maintain] to query the currently encountered problems.

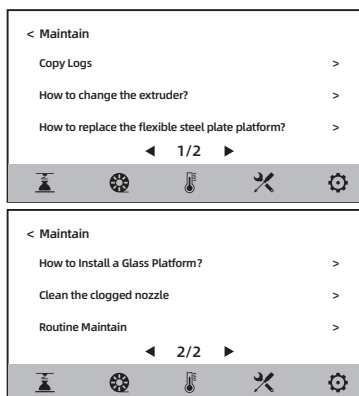
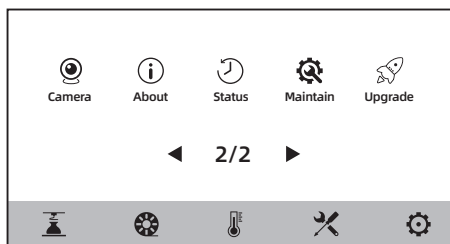

6.2 Extruder Maintenance

ATTENTION

When operating the extruder, the power supply must be disconnected.

6.2.1 Nozzle Replacement

The replacement method can be viewed by clicking the [How to change the extruder?] on the maintenance screen. Please operate following the instructions on the screen.

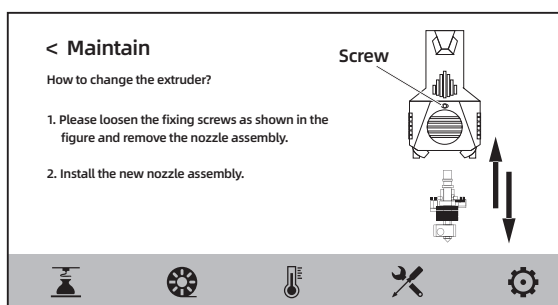

6.2.2 Clogged Nozzle Cleaning

The cleaning method can be viewed by clicking the [Clean the clogged nozzle] on the maintenance screen. Please operate following the instructions on the screen.

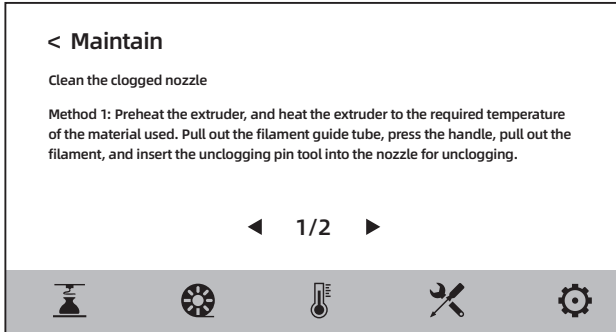

6.3 Platform Replacement

Note: After the glass platform and flexible steel plate platform are exchanged, the extruder height must be calibrated.

6.3.1 Glass Platform Replacement

The replacement method can be viewed by clicking the [How to Install a Glass Platform?] on the maintenance screen. Please operate following the instructions on the screen.

Note: The screws may become stripped after long-term use. If so, the spare screw holes on both sides can be used.

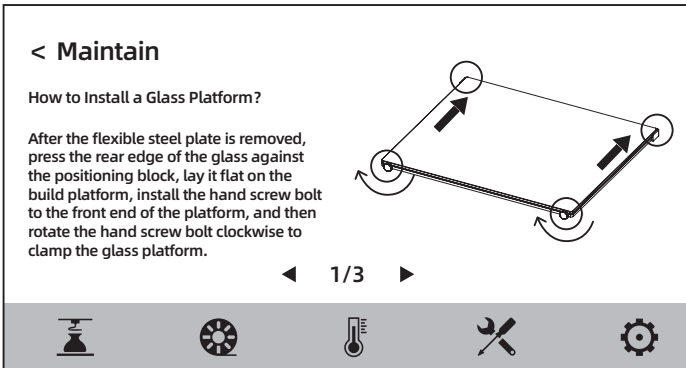

< Maintain

How to Install a Glass Platform?

2. When removing the glass platform, turn the hand screw bolt counterclockwise, and it can be removed when the glass is loose.

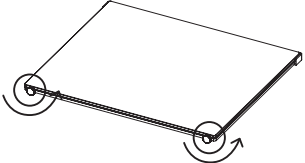

◀ 2/3 ▶



6.3.2 Flexible Steel Plate Platform Replacement

The replacement method can be viewed by clicking the [How to replace the flexible steel plate platform?] on the maintenance screen. Please operate following the instructions on the screen.

Note When using the flexible steel plate platform, please remove the front hand screw bolt.

< Maintain

How to replace the flexible steel plate platform?

1. Remove the steel plate and lift the handle directly;

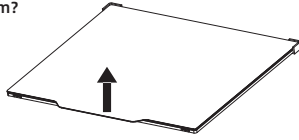

◀ 1/3 ▶



< Maintain

How to replace the flexible steel plate platform?

2. Install the steel plate, press the rear edge of the steel plate against the positioning block, and the steel plate will be automatically adsorbed.

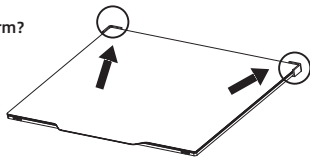

◀ 2/3 ▶



6.4 Platform Flatness Calibration

Generally, users do not need to carry out this operation. When the flatness of the equipment that has undergone Z-axis calibration or automatic leveling compensation is still improper, it may be that the previously installed platform flatness has been damaged. At this time, sensor calibration is required to adjust the platform flatness. Please operate following the prompts on the screen.

Special Note

1. Please perform sensor calibration when using flexible steel plate platform.
2. Before sensor calibration, the extruder will be heated. Please be careful to avoid touching the extruder to avoid burns.

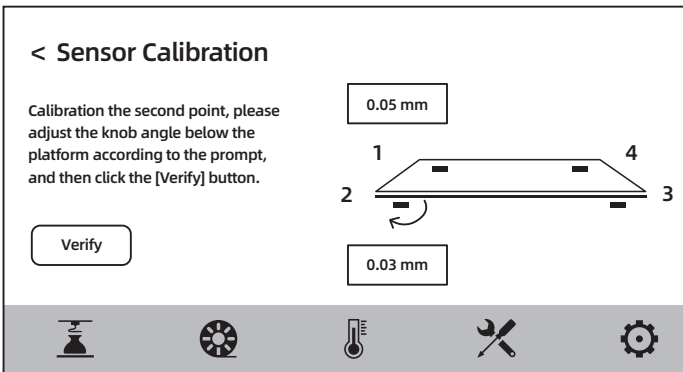
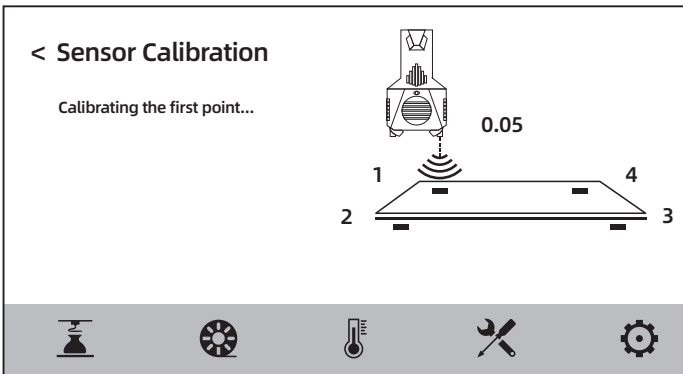

7. Q&A

Q1: How to deal with clogged nozzle?

Click the [] - [Maintenance].

////////////////////////////////////

Q2: How to replace the nozzle?

ATTENTION: Please disconnect the power before replacing the nozzle. Do not operate while energized.

Click the [] - [Maintenance].

////////////////////////////////////

Q3: Is there a need to calibrate the extruder after replacing the nozzle?

No.

////////////////////////////////////

Q4: Click to start printing the model, and the extruder moves, but there is no filament extrusion at the beginning of printing. How to deal with this situation?

1. Observe the filament guide tube to confirm whether the filament enters the extruder; If not, please click the [Load] button again until the filament is extruded from the extruder;
 2. Check whether the nozzle is clogged. If so, please check the Q1 for the solution.
- ////////////////////////////////////

Q5: The relative position between the nozzle and the platform is too high [far away from the platform] or too low [touching the platform] during printing. How to level it?

Click the [] - [Level and Calibration] - [Z Calibration] and then operate according to the screen prompts.

////////////////////////////////////

Q6: Can filaments of other brands be used?

Filaments of other brands can be used. But the parameters need to be adjusted due to the temperature difference of different filaments.

////////////////////////////////////

Q7: Is the equipment compatible with all AC inputs?

The equipment is compatible with 220V-240V or 100-120VAC input voltage. If the input voltage is different in different regions, it cannot be directly powered on, that is, for countries using 110VAC voltage, users shall purchase the equipment corresponding to 110VAC voltage.

////////////////////////////////////

Q8: Can the equipment automatically shut down after finishing printing?

Yes. This function can be enabled on the [] screen.

////////////////////////////////////

Q9: Is it safe to print ABS material?

ABS material will release toxic gases during heating, so it is recommended to turn on the HEPA air filter for filtration during or after printing. If conditions permit, it is recommended to place the equipment in an open environment for printing. It is recommended to print nontoxic materials such as PLA in children's activity places.

Q10: The printed model is warping or not sticking well. How to deal with this situation?

- Scheme 1: Increasing the platform temperature can effectively alleviate this problem, as the high temperature can increase the adhesion between the platform and the model.
- Scheme 2: Choosing to add a raft when slicing the model can effectively alleviate this problem.
- Scheme 3: Apply glue.
- Scheme 4: If the distance between the nozzle and platform is too large, it should be reduced accordingly, which can be done via the expert mode of extruder calibration and the calibration function.
- Scheme 5: Confirm whether the platform is laid flat. The calibration function can be used, and it is recommended to perform a full-process automatic leveling.

////////////////////////////////////

Q11: Must a raft be added when printing a model?

Not necessarily. When printing the raft, the filament extrusion amount is larger and the printing success rate is higher. Under the condition of raft heating, the adhesion between the model and the platform plate increases, which makes the model adhere to the platform well when printing, and also increases the printing success rate.

////////////////////////////////////

Q12: After inserting the USB flash drive, the print file can not be found, and the screen displays all as folders. How to deal with this situation?

The format of the USB flash drive is incorrect. The equipment supports FAT32 file system. Please format the USB flash drive into FAT32 format.

////////////////////////////////////

Q13: How to deal with Wi-Fi connection failure?

1. Please check whether the Wi-Fi name contains special characters. If so, please modify it and try again;
2. Please check whether the password contains special characters. If so, please modify it and try again.

////////////////////////////////////

Q14: What are matters needing attention in updating the firmware?

Please do not disconnect the power and the network when downloading or updating the firmware to avoid update failure.

////////////////////////////////////

Q15: Why is the boot screen white?

If the start-up sound can be heard, please replace the screen or the flat cable; If not, please contact our after-sales personnel.

////////////////////////////////////

Q16: Is it normal that yellowish-brown stains appear on the guide rails after a long time of use?

It is a normal phenomenon. The guide rails come with lubricating oil, and yellowish-brown stains will appear when the guide rails are used for a long time.

////////////////////////////////////

Q17: Is it normal for the machine to shake during printing?

It is a normal phenomenon. The faster the printing speed is, the more obvious the shaking of the machine will be.

8. Help and Support

Flashforge professional after-sales service personnel and salesmen are on standby for you at any time and are ready to help you with any problem you may have with the printer. If the issues or questions are not covered in this User Guide, you can seek for solutions on our official website or contact us via email or phone.

Some explanations and solutions of common problems can be found in our official website. Many of your problems can be solved in www.flashforge.com, the official English website of Flashforge.

Flashforge after-sales team can be reached by email or phone from 8:00 a.m. to 5:00 p.m. from Monday to Saturday to solve your problems. In case you contact us during off-duty time, your inquiry will be answered the following business day immediately. We are sorry for any inconvenience caused.

////////////////////////////////////

Note

Due to the replacement of different filaments, there will be a small amount of impurities left in the extruder, which will cause the nozzle clogged. As this can be solved by just unclogging it, it's not owing to quality issue. If users encounter this problem during use, please contact our after-sales personnel, and complete the unclogging operation under the guidance of our after-sales personnel.

////////////////////////////////////

After-sales Service Tel: +86-400-886-6023
E-mail: support@flashforge.com
Address: No. 518, Xianyuan Road, Wucheng District, Jinhua City, Zhejiang Province, China

Note: Please provide the product serial number which is the barcode at the back of the printer when contacting our after-sales personnel.



目录

注意事项

设备参数

第一章：设备简介 30

- 1.1 - 整机介绍 30
- 1.2 - 装箱清单 31

第二章：打印前准备 32

- 2.1 - 连通电源 32
- 2.2 - 安装丝料 33
- 2.3 - 校准设备 35
- 2.4 - 网络连接 36
 - 2.4.1 - 有线网络连接 36
 - 2.4.2 - 无线网络连接 36

第三章：软件安装 37

第四章：首次打印 37

- 4.1 - 文件传输：Wi-Fi传输 37
- 4.2 - U盘打印 37
- 4.3 - 云打印 38
- 4.4 - 摄像头连接查看 39
- 4.5 - 打印完成移除模型 39

第五章：设备操控界面简介 40

- 5.1 - 打印界面 40
- 5.2 - 丝料界面 41
- 5.3 - 预热界面 42
- 5.4 - 工具界面 42
- 5.5 - 设置界面 43

第六章：维护 44

- 6.1 - 维护界面 44
- 6.2 - 喷头维护 44
 - 6.2.1 - 更换喷嘴 44
 - 6.2.2 - 喷头堵头维护 45
- 6.3 - 更换平台 45
 - 6.3.1 - 更换玻璃平台 45
 - 6.3.2 - 更换柔性钢板平台 46
- 6.4 - 平台平面度校准 47

第七章：Q&A 48

第八章：帮助与支持 50

注意事项

安全提示：请确保认真阅读以下安全提示

注意：每台3D打印机在出厂前都经过打印测试，若设备喷头存在耗材残留或打印平台有轻微划痕，都属正常现象，不影响使用。

工作环境安全

- ◆ 请保证打印机的工作台面干净整洁。
- ◆ 请保证打印机工作时远离可燃性气体、液体及灰尘。设备运行产生的高温有可能会与空气中的粉尘、液体、可燃性气体反应引发火灾。
- ◆ 儿童及未经培训的人员请勿单独操作设备。

用电操作安全

- ◆ 请务必将设备接地；切勿改装设备的插头。未接地 / 未正确接地 / 改装插头必然会增加漏电风险。
- ◆ 请勿将设备暴露在潮湿或烈日的环境中。潮湿的环境会增加漏电的风险 / 暴晒会加速塑件老化。
- ◆ 请勿滥用电源线，务必使用闪铸科技提供的电源线。
- ◆ 切勿在雷雨天气使用设备。
- ◆ 如长时间不使用设备，请关闭设备并拔下电源线插头。

个人操作安全

- ◆ 在设备运行时，请勿触碰喷头、平台等位置！
- ◆ 请勿触碰喷头与平台，以免高温烫伤或机械损伤！
- ◆ 在操作设备时，请勿穿戴围巾、口罩、手套、珠宝装饰等容易卷入设备的物件！
- ◆ 请勿在饮酒、服药之后操作设备！

设备使用提示

- ◆ 保持设备内部整洁，切勿将金属物体掉入打印平台底部的滑槽内！
- ◆ 请及时清理丝料碎屑，建议在设备外进行操作！
- ◆ 自行对设备进行任何改装将不再享有保修权利！
- ◆ 请在设备进丝操作时，喷头和平台的距离至少保持50mm的距离。距离过近，有可能会造成喷头堵塞。
- ◆ 请在通风的环境下操作设备！
- ◆ 请勿利用该设备进行违法犯罪的活动！
- ◆ 请勿利用该设备制作食物储存类产品！
- ◆ 请勿将打印模型放入口腔！

设备运行环境要求

- ◆ 室内温度在15-30度为宜；湿度在20%-70%为宜

设备放置要求

- ◆ 设备需要被放置于干燥通风的环境中。设备左侧和后侧必须预留至少30cm的空间距离，右侧和前侧必须预留至少45cm的空间距离。
- ◆ 存储温度在0-40℃为宜。

设备兼容耗材要求

- ◆ 在使用该设备时，建议使用闪铸科技的耗材。如使用非闪铸科技的耗材，材料特性有一定差异，打印参数可能需要调整。

耗材存储要求

- ◆ 耗材拆封后请保持耗材的储存环境干燥及无尘，建议使用配套干燥盒存储。

法律申明

- ◆ 用户无权对此使用手册进行任何修改。
- ◆ 客户若自行拆装或改造设备造成任何安全事故，闪铸科技概不负责。未经闪铸科技允许，任何人不得对该手册进行修改或翻译。本手册受版权保护，闪铸科技对本手册保留最终解释权。
- ◆ 第一版（2022年8月）
@Copyright 2022浙江闪铸三维科技有限公司 版权所有

设备参数

设备名称	引领者 3
喷头数量	1
打印精度	± 0.15mm 或 0.002 mm/mm [以较大值为准]
定位精度	X/Y轴: 0.011mm Z轴: 0.0025mm
层厚度	0.05 ~ 0.4mm
打印尺寸	300x250x340mm
喷嘴口径	默认0.4mm [选配0.6/0.8mm]
喷嘴类型	不锈钢喷嘴
打印速度	10 ~ 250mm/s
最高喷头温度	320°C
平台最高温度	110°C
支持耗材类型	PLA/PETG/ASA/ABS/PC/PA/PLA-CF PETG-CF/PETG-GF/PA-CF/PA-GF
电源	AC100-240V/DC 24V/20.8A, 500W
切片软件	FlashPrint
输入/输出文件类型	输入: 3MF/STL/OBJ/FPP/BMP/PNG JPG/JPEG 文件; 输出: GX/G 文件/ gcode
打印连接方式	U盘/以太网/Wi-Fi
工作温度	15 ~ 30°C
兼容的操作系统	Windows XP/Vista/7/8/10、Mac OS
兼容的切片软件	Slic3r, Cura [需设置]
智能触控液晶屏	4.3 英寸
打印平台	柔性钢板平台/玻璃平台
设备净重	27kg
设备尺寸	496x436x696mm [长宽高]
装机空间要求	≥590*543*758mm

第一章：设备简介

1.1 整机介绍

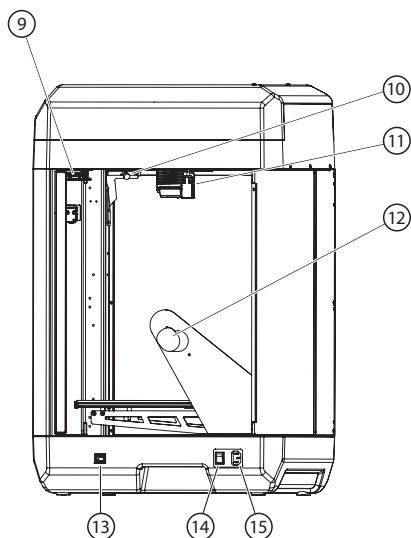
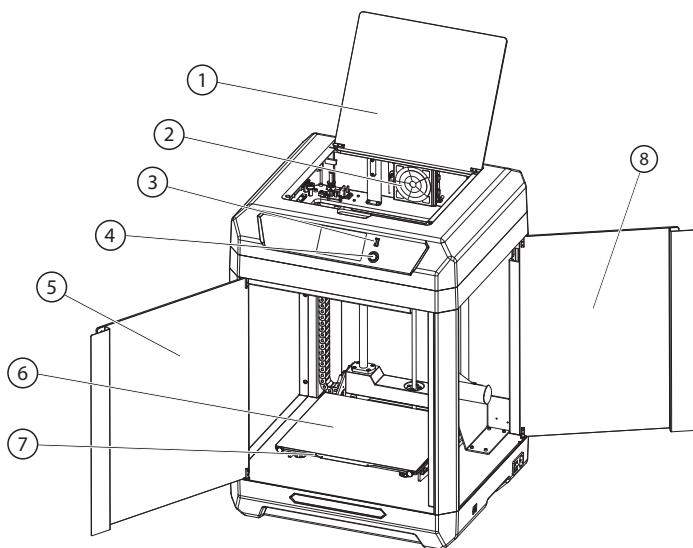

1. 上盖 2. 空气过滤 3. USB接口
4. 屏幕开关 5. 前门 6. 柔性钢板
7. 平台板 8. 耗材舱门 9. 腔体灯
10. 摄像头 11. 喷头
12. 丝料盘固定架 13. 网线接口
14. 电源开关 15. 电源接口

1.2 装箱清单

			
3D打印机	3D打印耗材	电源线	售后服务卡
			
说明书	润滑脂 x 2	毛刷	水洗胶
			
铲刀	尖嘴钳	斜口钳	一字螺丝刀
			
通针	内六角扳手套装	弯头镊子	调平片
			
隔热手套	U盘	保险丝 x 2	导热胶
			
玻璃平台	手拧螺栓 x 2		

第二章：打印前准备

2.1 连通电源

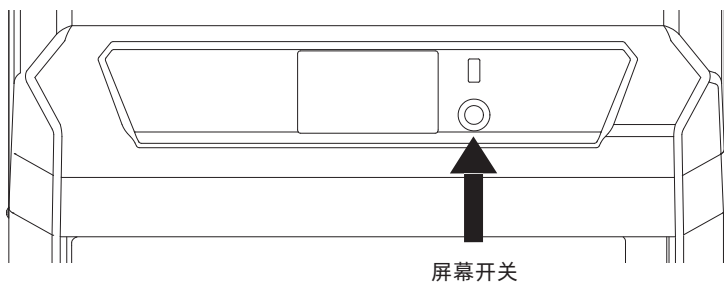
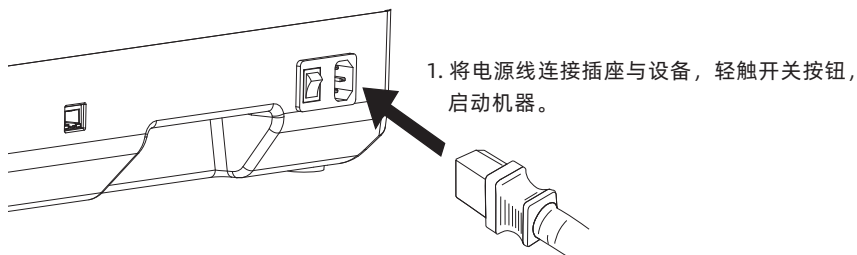

2. 打开屏幕开关，点亮屏幕。

2.2 安装丝料

1. 打开丝料舱门，将丝料挂到丝料架上，按照顺时针方向穿过舱内左上方对应的丝料传感器，直至从导丝管另一端看到丝料。

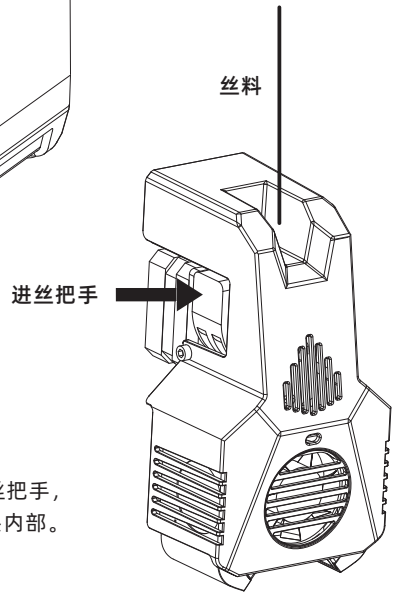
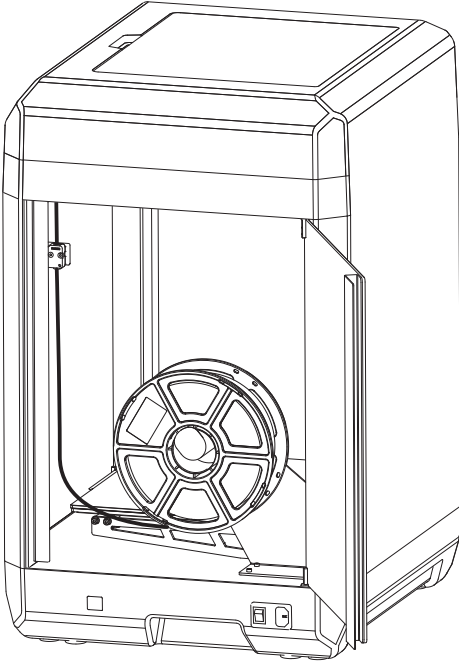

2. 按下喷头上的进丝把手，将丝料插入到喷头内部。

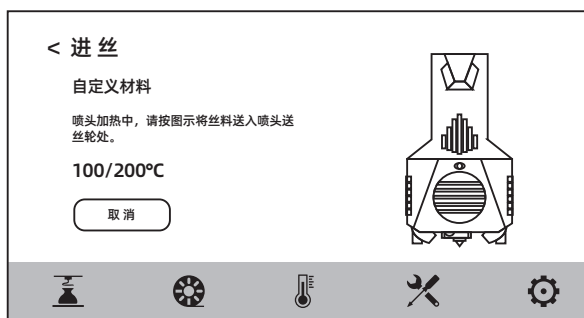
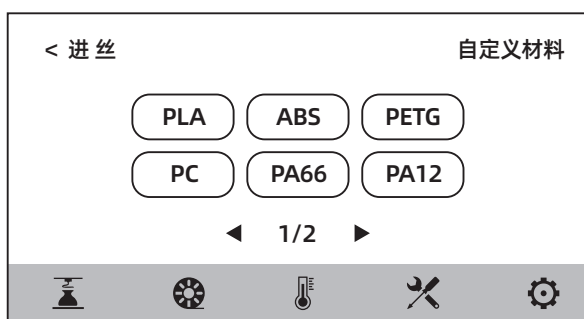
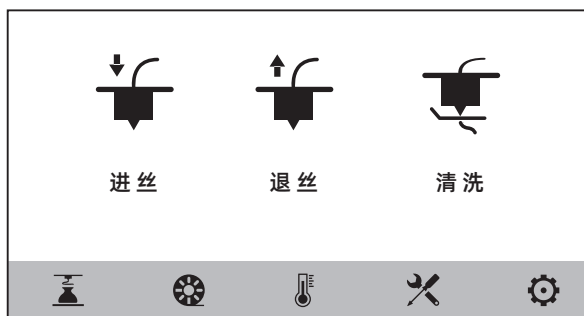

3. 点击屏幕[丝料] - [进丝], 选择喷头对应材料, 开始进丝, 按屏幕提示操作。

2.3 校准设备

设备包含如下调平校准操作：

Z轴校准、传感器校验、辅助调平 [完整模式、简化模式]。

设备在出厂前进行过调平校准，一般无需再次校准。但由于运输震动关系，调平面可能被破坏，建议在首次使用前分别进行一次Z轴校准和传感器校验。

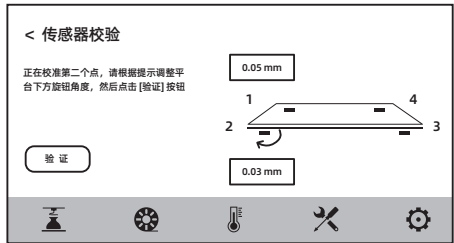
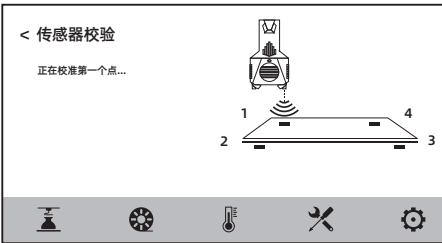
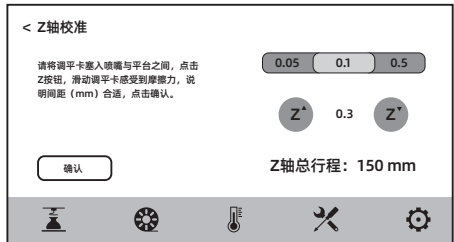
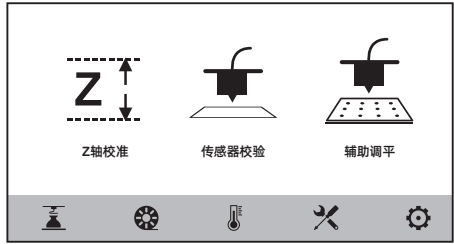

请按右侧顺序进行操作[可参考操作视频]:

1. 在触控屏上点击[工具] - [调平与校准];
2. 选择Z轴校准;
3. 进行Z轴校准，按屏幕提示进行操作。
4. 选择传感器校验;
5. 进行传感器校验，按屏幕提示操作。

2.4 网络连接

2.4.1 有线网络连接

1. 将网线插入设备背部的网线接口。
2. 点击屏幕[工具]-[网络], 选择有限网络, 打开有限网络开关。若屏幕右上角出现  图标, 则表明设备已经成功连接网络。

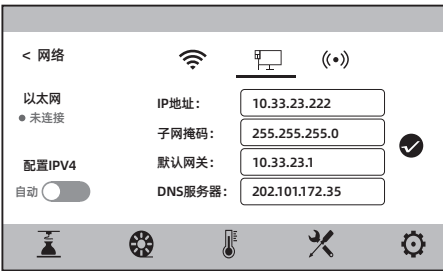

2.4.2 无线网络连接

连接无线网络前, 请确保已安装Wi-Fi, 否则无线信号将被影响。



1. 点击屏幕[工具]-[网络], 选择无线网络。打开无线网络开关。
2. 点击连接对应无线网络, 连接成功后屏幕上会出现相应提示。当右上角出现  图标时, 则表明设备已经成功连接无线网络。

第三章：软件安装

方法一：在U盘中找到 FlashPrint 软件安装包，选择对应的系统版本进行安装。

方法二：从中文官方网站 www.sz3dp.com 下载最新的切片软件。

3D 打印过程：

获取模型文件 - 使用切片软件进行切片 - 文件传输至打印机打印。

第四章：首次打印

4.1 文件传输：Wi-Fi传输

将文件导入FlashPrint进行切片，选择引领者3设备关联机器[还可通过输入IP地址或自动扫描的方式，IP地址可在设备[关于]中查看]。切片完成后直接发送文件至打印机即可打印。

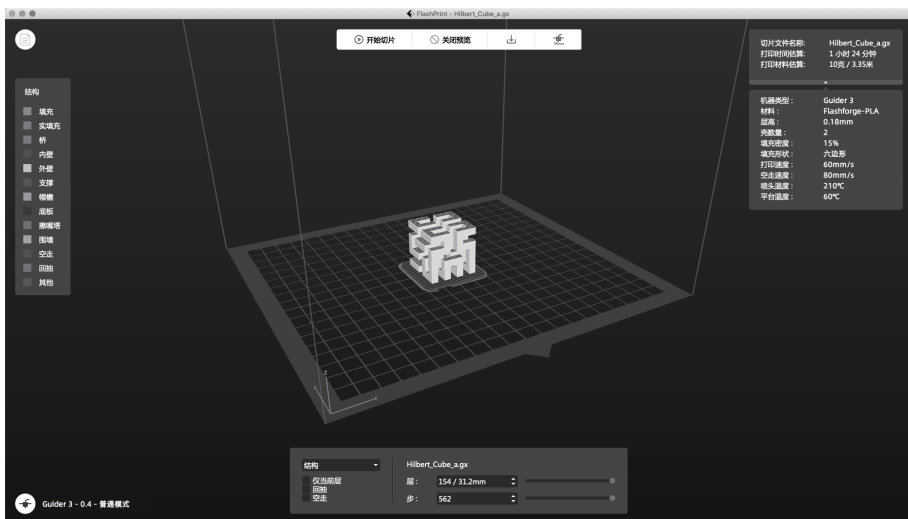

4.2 U盘打印

设备也可通过U盘打印。将切片好的文件保存至U盘，将U盘插入设备，选择对应文件即可打印。

4.3 云打印

闪铸云打印

1. 打开闪铸云网站，注册账号，经过邮箱激活后，即可登录使用。
闪铸云：<https://cloud.sz3dp.com>



2. 点击 [我的打印机] - [添加打印机]。

在添加打印机页面填写注册号[云注册号]，为打印机起个名字，点击确定后，这些信息会出现在打印机的闪铸云界面。

Polar云打印

1. 打开Polar云网站，注册账号。Polar云：<https://Polar 3d.com>

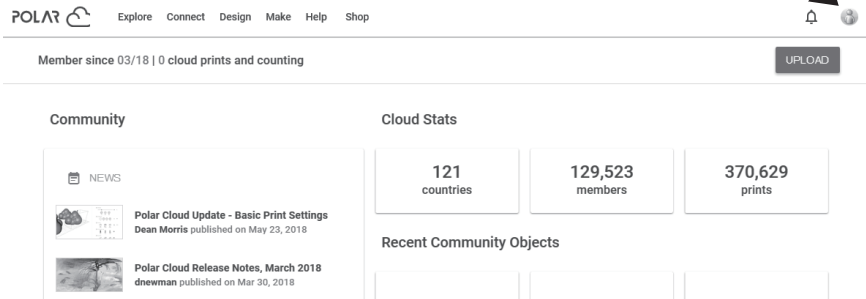

2. 登录后，点击右上角头像图标，点击[Settings]，点击菜单中的PIN Code查询PIN码。
引领者3连接网络后打开Polar云开关，输入账号与PIN码即可。

4.4 摄像头连接查看

1. 使用摄像头前，请取下摄像头盖子；
2. 打开摄像头开关；
3. 设备与FlashPrint连接后可以在FlashPrint-[多机控制]中查看到实时视频画面。

4.5 打印后模型移除

警告

从打印平台上移除模型时，请注意需要等待平台冷却后再操作。此时可查看屏幕顶部状态栏温度图标来确认平台温度，绿色图标表示平台温度低于50°C，可进行安全操作。移除模型时可以使用配套手套，同时务必注意设备高温。

1. 如使用柔性钢板平台，打印完成后，直接抬起把手取下柔性钢板，将平台板折弯即可取下模型；
2. 如使用玻璃平台，打印完成后，直接用铲刀铲下模型即可。

柔性钢板平台

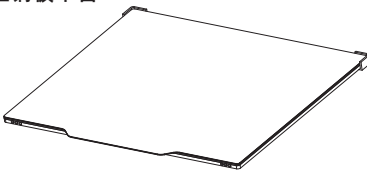

玻璃平台

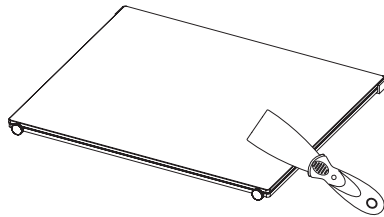

使用柔性钢板平台，取下模型重新将平台板放回设备，操作如下：

1. 将柔性钢板后端顶住平台左右边缘的定位块[注意是插入定位块的内侧]；
2. 平台自动吸附安装到平台上。

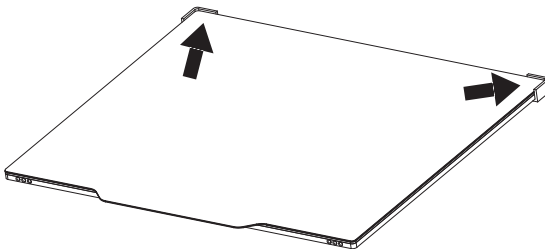

第五章：设备操控界面简介

注意事项

因固件会不定期升级，UI界面请以实际显示页面为准，以下仅为功能简介。

5.1 打印界面

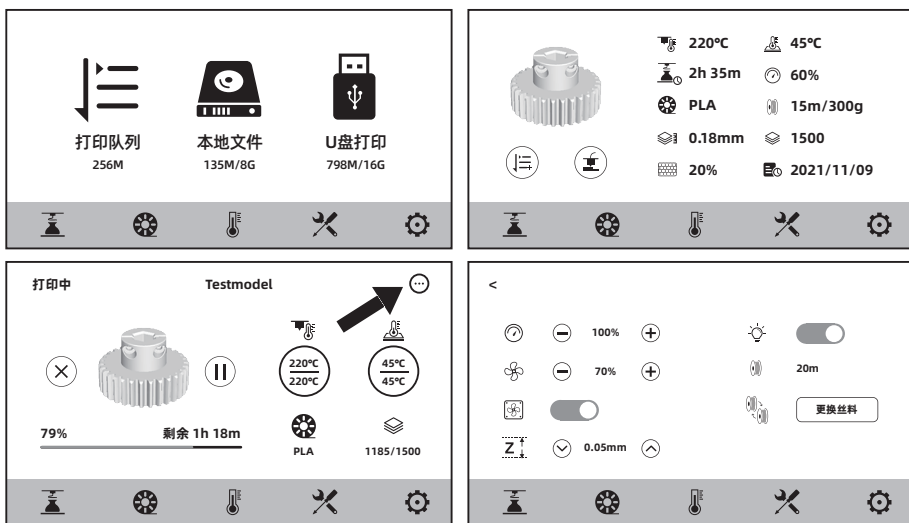

打印时可进行部分参数调整。点击 图标可进行打印速度，风扇，灯的控制。

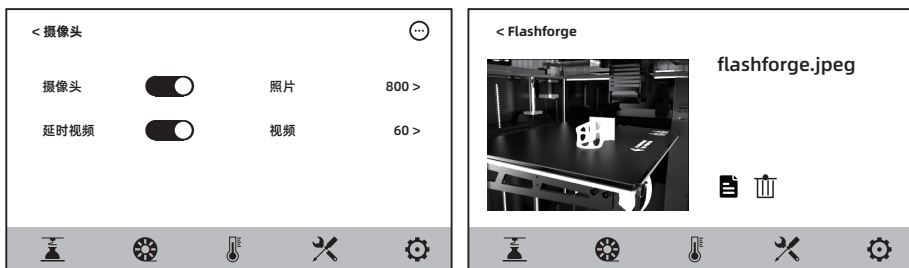

打开摄像头后还可以在屏幕上直接查看打印状态并存储画面。

5.2 丝料界面

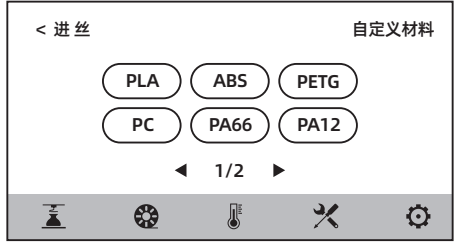
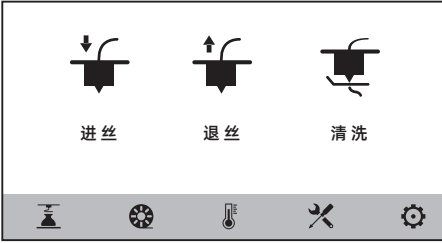

丝料界面包含：进丝，退丝，清洗。

进丝与退丝时，用户可根据实际需要安装的丝料进行选择，若界面中无当前所需的丝料，用户可以自定义丝料，设置进丝时所需的温度。

丝料清洗

当前后两次打印的丝料不同时，请进行丝料清洗。如此可避免发生由于丝料的熔融温度不同造成丝料碳化堵头或不出丝的情况。从打印温度高的丝料切换到打印温度低的丝料时，此操作必须执行；例如使用PC材料打印后，切换为PLA材料，需将PC材料从喷嘴中清洗干净，因此需要设置PC熔化所需的温度，直至PC材料全部从喷嘴中被挤出，没有残留在喷嘴中。

5.3 预热界面

预热界面可以根据需要提前设置喷头、平台的温度。

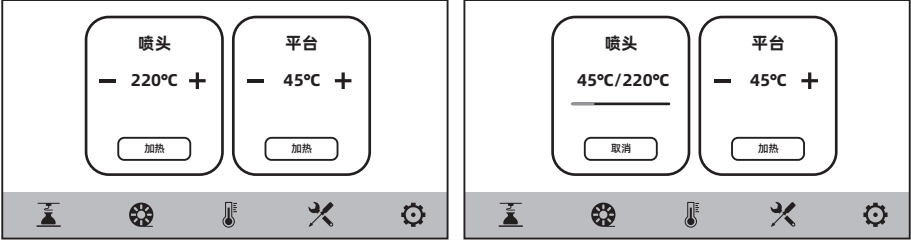

5.4 工具界面



【调平与校准】 Z轴校准、传感器校验、辅助调平[完整模式、简化模式]

【回 零】 设备各轴回到零点位置

【网 络】 无线网络，有线网络，热点

【摄像头】 打开摄像头与延时视频

【状 态】 设备的运行状态

【升 级】 固件升级，可在无线网络连接时，升级到设备最新的固件

【移 动】 手动移动设备XYZ轴

【云平台】 连接闪铸云、Polar平台

【关 于】 关于设备的基本信息

【维 护】 维护条目，用户若遇问题，可在此处查看

5.5 设置界面



在设置界面中可开启或关闭各项功能。

- ◆ 空气过滤功能开启时，设备背部风扇启动；风扇前部装有HEPA滤棉，可以过滤打印时产生的粉尘和异味。
- ◆ 平台保温功能开启时，可设置打印前后的平台保温时间。取模型过渡状态时，避免消耗温度下降需重新加热的的时间。此功能开启时，在打印完成后取模型时平台仍保持加热状态，请注意高温并避免烫伤。
- ◆ 腔体灯开启时，可调节腔体内部灯光明暗。
- ◆ 丝料检测功能开启时，设备将会在打印中途丝料用完时停止打印。
- ◆ 断电续打功能开启时，若设备打印中途突遇断电，设备将会自动存储当前打印的位置数据，在电源恢复后可继续进行当前模型的打印。
- ◆ 自动关机功能开启时，设备将会在模型打印完成后自动关机。

第六章：维护

注意事项

因固件会不定期升级，UI界面请以实际显示页面为准，以下仅为功能简介。

6.1 维护界面

点击[工具]，可在[维护]界面中查询当前所遇问题项。



6.2 喷头维护

注意事项

操作喷头时，需断开电源。

6.2.1 更换喷嘴

可在维护界面中[更换喷嘴]查看更换方法，按屏幕示意操作。

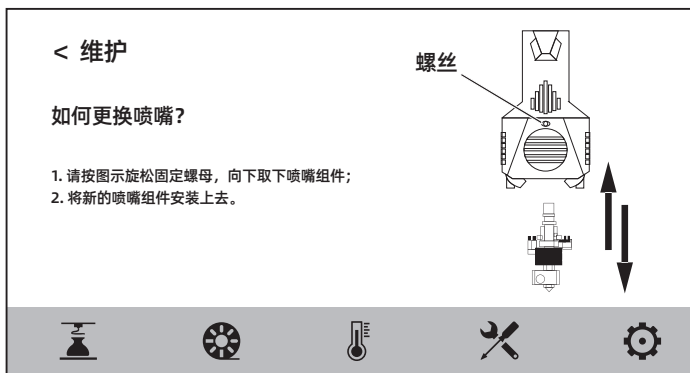

6.2.2 喷头堵头清理

可在维护界面中[堵头清理]查看更换方法，按屏幕提示方法操作。

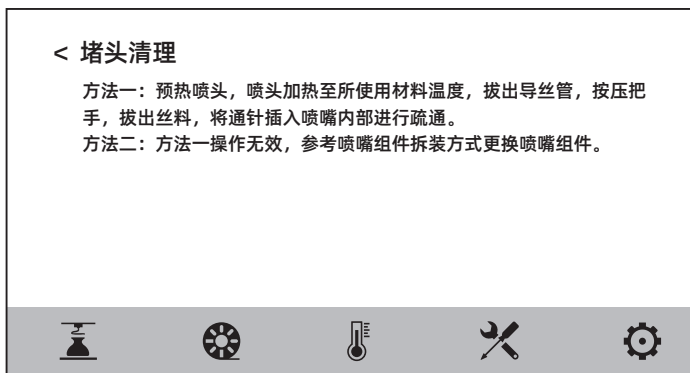

6.3 更换平台

注：玻璃平台和柔性钢板平台互换后，务必进行喷头高度校准。

6.3.1 更换玻璃平台

可在维护界面中[如何更换玻璃平台]查看更换方法，按屏幕示意操作。

注：长时间使用可能会出现螺丝滑牙的情况，可更换使用两侧的备用螺丝孔。

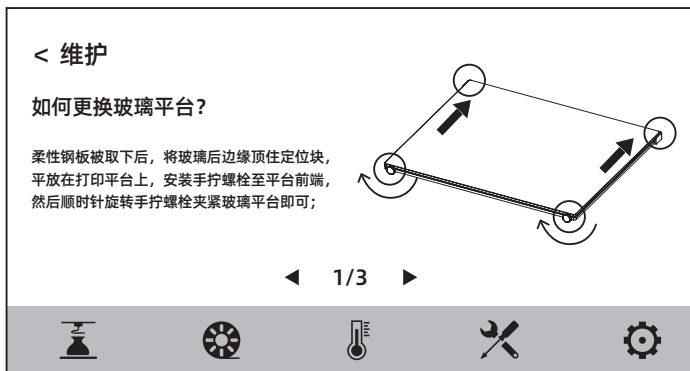

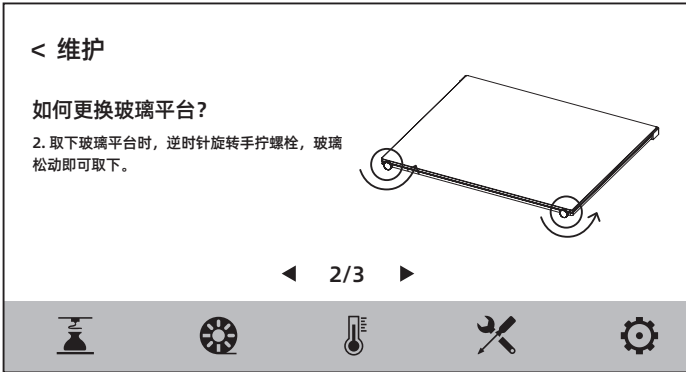

6.3.2 更换柔性钢板平台

可在维护界面中[如何更换柔性钢板平台]查看更换方法, 按屏幕示意操作。

提示: 使用柔性钢板平台时, 请取下前端的手拧螺栓

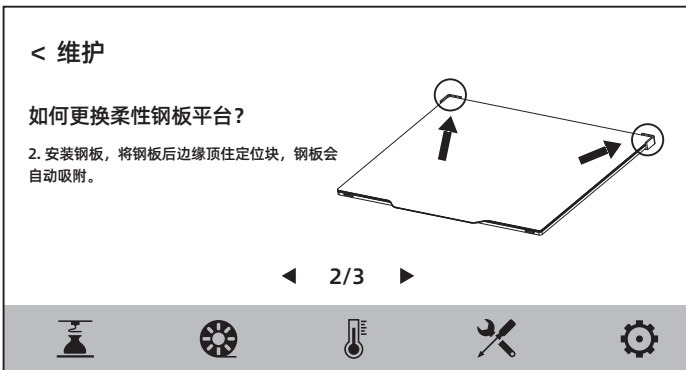
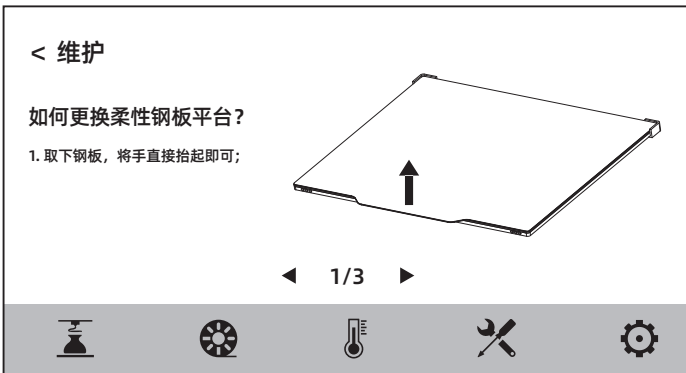

6.4 平台平面度校准

用户一般无需进行此操作，当设备平面度经过Z轴校准或者自动调平补偿无效的时候，可能是平台安装的平面度已受到破坏，此时需要进行传感器校验以调整平台平面度。根据屏幕提示操作即可。

特别提示：1. 请在使用柔性钢板平台的前提下进行传感器校准操作。

2. 传感器校验前会先加热喷头，请注意避免触碰喷头以免烫伤。

第七章：Q&A

Q1：喷嘴堵头怎么办？

点击[工具]-维护说明。

////////////////////////////////////

Q2：如何更换喷嘴？

注意事项：更换喷嘴前请先关机断电，请勿带电操作。

点击[工具]-维护说明。

////////////////////////////////////

Q3：更换喷嘴后需要校准喷头吗？

不需要。

////////////////////////////////////

Q4：点击打印模型，喷头运动，但打印一开始就没有出丝怎么办？

1. 观察导丝管，确认丝料是否已进入喷头，若无，请再点击进丝按钮，直至丝料从喷头中吐出；
 2. 查看喷头是否堵头，若是，解决方案请查看Q1。
- ////////////////////////////////////

Q5：打印时发现喷嘴与平台相对位置过高[远离平台]或过低[顶到平台]怎么办？如何调平？

在工具页面，选择[调平与校准]-Z轴校准，按页面提示操作。

////////////////////////////////////

Q6：可以使用其他品牌的丝料吗？

可以使用其他品牌丝料，但由于不同材料参数温度略有区别，需要经过参数调整配置。

////////////////////////////////////

Q7：产品兼容所有AC输入吗？

产品适配220V-240V或100-120VAC的输入电压。不同区域之间若输入电压不同不能直接上电使用，即110VAC电压的国家需购买对应110VAC电压的设备。

////////////////////////////////////

Q8：产品打印完成后可以自动关机吗？

可以。在[设置]页面中打开该功能即可。

////////////////////////////////////

Q9：打印ABS材料安全吗？

ABS在加热过程中会释放有毒气体，建议打印时或打印后开启HEPA空气过滤器进行过滤。如条件允许，建议将设备置放在开阔环境下打印。儿童活动场所建议打印PLA无毒材料。

第八章：帮助与支持

闪铸专业的售后服务人员及业务员随时为您待命，非常乐意为您解决在您使用过程中遇到的任何问题。如果您无法从用户手册中找到答案，您可以进入我们的官方网站来搜索问题的解决方案，或者通过电话联系我们。

在我们的官网中可以找到一些常见问题的说明和解决方法。您的许多问题都可以在闪铸科技中文官方网站www.sz3dp.com得到解决。

您可以在周一到周六上午8:00到下午5:00通过电话来联系闪铸售后团队，为您解决问题。如果您在下班时间联系我们，闪铸将在下一个工作日的第一时间给您反馈。若造成不便，我们万分抱歉。



提示

由于更换不同的丝料，会有少量杂质残留在喷头中造成喷头堵塞，疏通后即可，不属于质量问题。若用户使用时存在该问题，请联系售后，并在售后的指导下完成疏通工作。



售后服务热线：400-886-6023

邮箱：support@flashforge.com

公司地址：浙江省金华市婺城区仙源路518号

提示：联系售后时，需提供产品序列号，即打印机背部的条形码





Follow us

Zhejiang Flashforge 3D Technology Co., Ltd.

Address: No.518 XianYuan Road, Jinhua City, Zhejiang Province, China

Service Hotline: +86 579 82273989

support@flashforge.com