

CN/EN-A01

Creator 4 金刚狼4系列

# 用户使用手册

USER GUIDE

中文P35

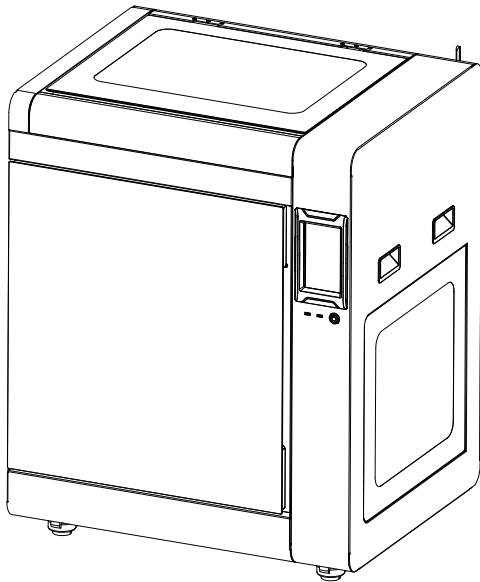

This guide is only applicable to FLASHFORGE Creator 4 3D printer

本手册仅适用于闪铸科技 金刚狼4 3D打印机

# CONTENT

<b>Notice</b>	<b>02</b>
<b>Equipment Parameter</b>	<b>05</b>
<b>1. Equipment Introduction</b>	<b>06</b>
1.1 - Creator 4 Introduction	06
1.2 - Unpacking and Installation	07
1.3 - Packing List	09
<b>2. Preparation Before Printing</b>	<b>11</b>
2.1 - Filament Loading	11
2.2 - Equipment Calibration	12
2.3 - Internet Connection	13
2.3.1 - Wired Network Connection	13
2.3.2 - Wireless Network Connection	13
<b>3. Software Installation</b>	<b>14</b>
<b>4. First Printing</b>	<b>14</b>
4.1 - File Transfer: Wi-Fi Transfer	14
4.2 - Printing via USB Flash Drive	15
4.3 - Printing via FlashCloud	15
4.4 - Model Removal After Finishing Printing	15
<b>5. Equipment Configuration and Operation</b>	<b>17</b>
5.1 - Normal Mode	17
5.2 - Dual-extruder Printing Mode	17
5.3 - Mirror/Duplicate Mode	20
5.4 - Filament Configuration	21
5.5 - Filament Parameter Setting	22
5.6 - Removal Method of Water-soluble Support Material	23
5.7 - Camera Connection	23
<b>6. Equipment Operation Interface Introduction</b>	<b>24</b>
6.1 - Printing Screen	24
6.2 - Filament Screen	25
6.3 - Preheating Screen	26
6.4 - Tools Screen	26
6.5 - Setting Screen	27
<b>7. Maintenance</b>	<b>28</b>
7.1 - Maintenance Screen	28
7.2 - Extruder Maintenance Introduction	29
7.2.1 - Extruder Parts Diagram	29
7.2.2 - Clogged Nozzle Cleaning	29
7.2.3 - Platform Flatness Calibration	30
<b>8. Q&amp;A</b>	<b>32</b>
<b>9. Help and Support</b>	<b>34</b>

# NOTICE

## Safety notice: Please strictly follow all the safety warnings and notices below all the time.

**Note:** Every 3D printer has undergone printing tests before leaving the factory. If there are some residues in the extruder of the equipment or some slight scratches on the build plate, it is normal and will not affect its use.

### WORK ENVIRONMENT SAFETY

- ◆ Please keep the work table of the equipment clean and tidy.
- ◆ Please ensure that the equipment is away from combustible gases, liquids and dust when working. (The high temperature generated by the equipment operation may react with combustible gases, liquids, and airborne dust, thus causing fire)
- ◆ Children and untrained personnel are not allowed to operate the equipment alone.

### ELECTRICAL SAFETY

- ◆ Be sure to ground the equipment. Do not modify the plug of the equipment. Ungrounded equipment/improperly grounded equipment/modified plug will inevitably increase the risk of electric leakage.
- ◆ Do not expose the equipment to damp or hot-sun environment. (Humidity will increase the risk of electric leakage.Exposure to sunlight will accelerate the aging of plastic parts)
- ◆ Make sure to only use the power cord provided by Flashforge.
- ◆ Do not use the equipment during an thunderstorm.
- ◆ Please shut down the equipment and unplug it if it is not in use for a long time.

### PERSONAL SAFETY

- ◆ Do not touch the extruder and build plate, etc during printing.
- ◆ Do not touch the extruder and build plate when finishing printing in order to avoid high temperature burns or mechanical damage.
- ◆ Do not wear scarves, masks, gloves, jewelry ornaments or other objects that can easily get caught in the equipment when operating it.
- ◆ Do not operate the equipment while you are tired or under the influence of drugs, alcohol or medication.

## CAUTIONS

- ◆ Keep the inside of the equipment clean and tidy. Do not drop metal objects into the slide chute at the bottom of the build plate.
- ◆ Please clean up the filament debris in time. It is recommended to operate this outside the equipment.
- ◆ Any modification of the equipment by yourself will result in that you will not be entitled to warranty rights anymore.
- ◆ Please keep the distance between the extruder and build plate for at least 50mm during filament loading operation. Too-close distance may cause clogged nozzle issue.
- ◆ Please operate the equipment in a well-ventilated environment.
- ◆ Do not use the equipment for illegal activities.
- ◆ Do not use the equipment to make any food storage products.
- ◆ Do not put the printed model into your mouth.

## EQUIPMENT ENVIRONMENT REQUIREMENTS

- ◆ The room temperature should be between 15°C and 30°C.
- ◆ The humidity should be between 20RH% and 70RH%.

## EQUIPMENT PLACEMENT REQUIREMENTS

- ◆ The equipment must be placed in a dry and ventilated environment. At least 30cm space must be reserved on the left side and rear side of the equipment, and at least 60cm space must be reserved on the right side and front side of the equipment. The storage temperature should be between 0°C and 40°C.

## COMPATIBLE FILAMENT REQUIREMENTS

- ◆ When using the equipment, it is recommended to use Flashforge filaments. If non-Flashforge filaments are used, there will be certain differences in material characteristics, and thus printing parameters may need to be adjusted.

## FILAMENT STORAGE REQUIREMENTS

- ◆ Please keep the storage environment of filaments dry and dust-free after unpacking. It is recommended to use the matching drying box for storage.

## LEGAL STATEMENT

- ◆ The user has no right to make any modification to this user guide.
- ◆ Flashforge will not be responsible for any safety accidents caused by the disassembly or modification of the equipment by the customer. No one is allowed to modify or translate this guide without the permission of Flashforge. This guide is protected by copyright, and Flashforge reserves the right of the final interpretation of this guide.
- ◆ First Edition (August 2021)  
@Copyright 2021 Zhejiang Flashforge 3D Technology Co., Ltd. All Rights Reserved.

# Equipment Series

<b>Creator 4F</b>	<b>Extruder F</b>	<b>Suitable for printing flexible filaments</b>
<b>Creator 4A</b>	<b>Extruder HT</b>	<b>Suitable for printing general/engineering filaments</b>
<b>Creator 4S</b>	<b>Extruder HT/Extruder HS</b>	<b>Suitable for printing composite filaments</b>

## Equipment Parameter

<b>Build Volume</b>	400*350*500mm
<b>Layer Height</b>	0.05mm-0.4mm
<b>Printing Accuracy</b>	±0.2mm or 0.002mm/mm (The larger values shall prevail.)
<b>Printing Speed</b>	10-200mm/s (it can be adjusted according to different materials and printing components)
<b>Print Technology</b>	FFF (Fused Filament Fabrication)
<b>Maximum Platform Temperature</b>	130°C
<b>Maximum Chamber Temperature</b>	65°C
<b>Extruder</b>	IDEX (Independent Dual Extruders)
<b>Extruder Type</b>	Direct Drive Extruder
<b>Nozzle Diameter</b>	0.4mm (default); 0.6/0.8mm (optional)
<b>Maximum Extruder Temperature</b>	F: 265°C; HT: 320°C; HS: 360°C
<b>Supported Filament</b>	TPU, PLA, PVA, PETG, TPU 98A, ABS, PP, PA, PC, PA12-CF, PET-CF
<b>Filament Spool Capacity</b>	1KG+2KG
<b>Slicing Software</b>	FlashPrint
<b>Supported Format</b>	Input: 3MF/STL/OBJ/FPP/BMP/PNG/JPG/JPEG; Output: GX/G
<b>Connectivity</b>	USB flash drive/Ethernet/Wi-Fi
<b>Touch Screen</b>	7-inch display screen with the resolution as 1024*600
<b>Appropriate Temperature for Printing</b>	15-30°C
<b>Appropriate Humidity for Printing</b>	20-70RH%
<b>Power</b>	2320W
<b>Power Supply Input</b>	AC 100-130V/200-240V; 50-60Hz
<b>OCP (over-current protection)</b>	30A
<b>Net Weight</b>	90kg
<b>Printer Size</b>	840X*675Y*1000Z(1050)mm
<b>Installation Space Requirements</b>	≥1400*1500*1600mm

# 1. Equipment Introduction

## 1.1 Creator 4 Introduction

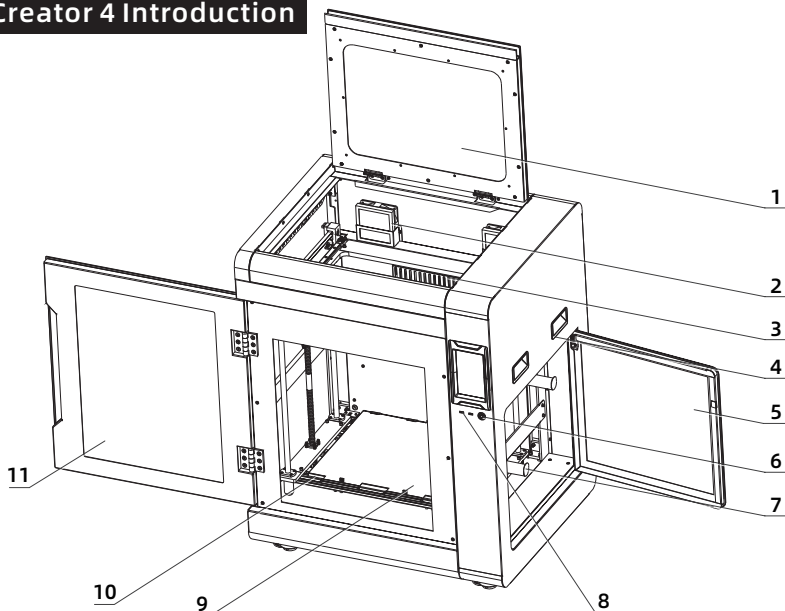

- 1. Upper Cover
- 2. Filter Fan
- 3. Inner Chamber Heating Assembly
- 4. Handle
- 5. Filament Door
- 6. Power Switch
- 7. Filament Spool Fixing Frame
- 8. USB Port
- 9. Flexible Steel Plate
- 10. Platform Plate
- 11. Front Door
- 12. Extruder
- 13. Camera
- 14. Ethernet Port
- 15. Power Port
- 16. LED Board

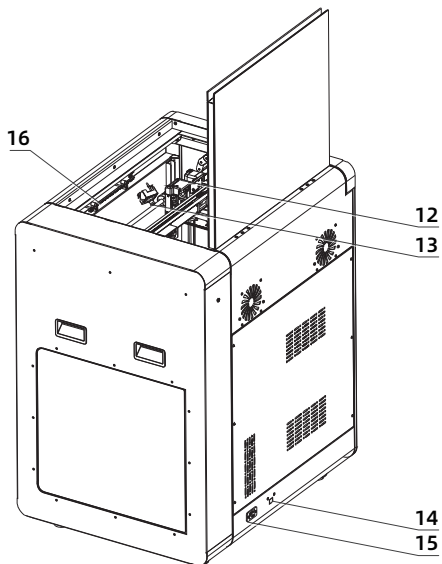

## 1.2 Unpacking and Installation

### ATTENTION



- 1) To ensure the smooth transportation of the equipment, please use an automatic or manual forklift with appropriate specifications for handling.
- 2) Before unpacking, please make sure that the outer box of the equipment is intact.

### Unpacking steps:

1. Use special tools to open the steel-edged wooden case;
2. Remove the steel-edged wooden case board and take off the protective foam;
3. Lift the equipment from the bottom of the wooden case;
4. Remove the protective wrapping film from the machine surface;
5. Open the front door of the machine and take out the power cord;
6. Connect the power cord to the socket and the equipment;
7. Touch the power switch slightly to start the machine;

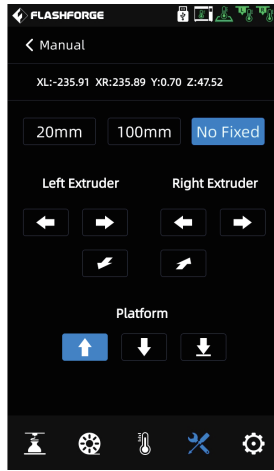
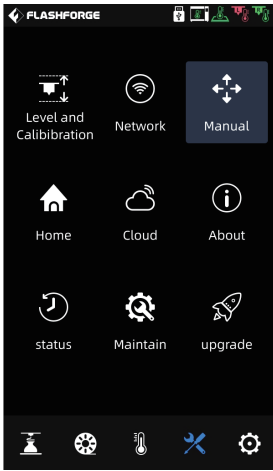



8. Click the -[Manual] on the screen, select the "No Fixed", press and hold the  , the Z axis will rise to about 100 to 120mm, and then take out the inner pearl cotton;
9. Take out all pearl cotton and accessory boxes inside the equipment;
10. Use the accessory diagonal pliers to cut off the X-axis and Y-axis fixing ties (be careful not to cut off the ties of the filament guide tube and the extruder harness), and move the left and right extruders to ensure that they can move freely in X and Y directions;
11. Adjust the casters at the bottom of the equipment, make it rotate clockwise, and the foot pad will rise, so that the equipment can be pushed. Move the equipment to the position to be placed, and then adjust the casters counterclockwise to fix the equipment. At this time, the casters will not be able to rotate (when the equipment is installed, the installation space size should not be less than 1400\*1500\*1600mm);
12. Install the Wi-Fi antenna. Take out the Wi-Fi antenna from the accessory box, install it on the back of the equipment, and screw it tightly. The position is shown in the figure:

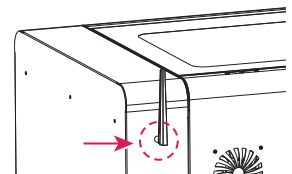

## 1.3 Packing List

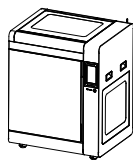

3D Printer



3D Printing Filament\*2

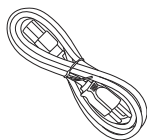

Power Cord



After-sales Service Card



User Guide

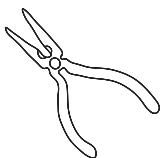

Nipper Pliers

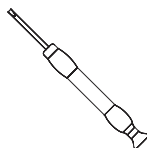

Straight Screwdriver

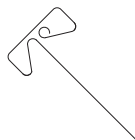

Unclogging Pin Tool



Allen Wrench

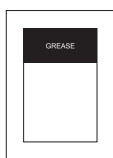

Lubricating Grease\*2

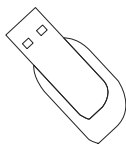

USB Flash Drive

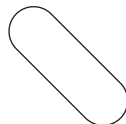

Leveling Card

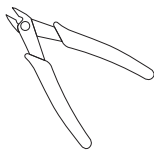

Diagonal Pliers

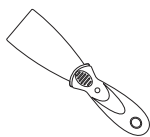

Scraper



Heat Insulating Gloves

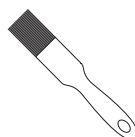

Cleaning Brush



Desiccant\*2

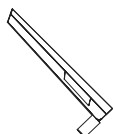

Wi-Fi Antenna

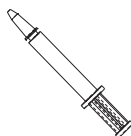

Thermally conductive adhesive\*2

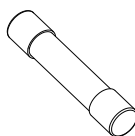

Fuse\*5

Different equipment versions correspond to different equipment packaging configurations, with the following differences:

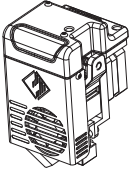
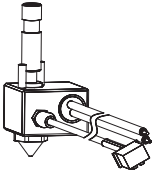
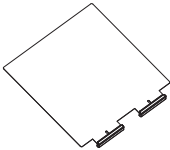
Equipment	Creator 4F	Creator 4A	Creator 4S
 <p data-bbox="82 480 291 507">Extruder Assembly</p>	/	/	HT Extruder*2
 <p data-bbox="93 751 280 778">Nozzle Assembly</p>	F Nozzle Assembly*2	HT Nozzle Assembly*2	HS Nozzle Assembly*2
 <p data-bbox="89 991 278 1050">Flexible Platform Steel Plate</p>	/	/	1

# 2.Preparation Before Printing

## 2.1 Filament Loading

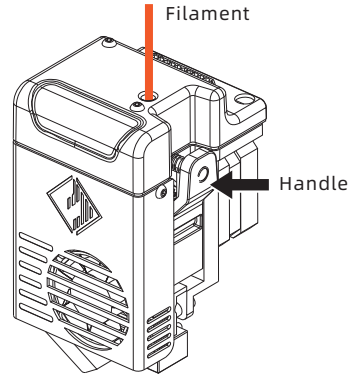
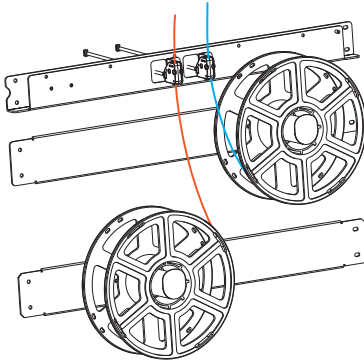

1. Open the door of the filament spool, hang the filament on the filament spool holder, and pass the filament through the corresponding filament sensors respectively until the filament is seen from the other end of the guide tube;

2. Press the filament feeding handle on the extruder to insert the filament into the extruder;

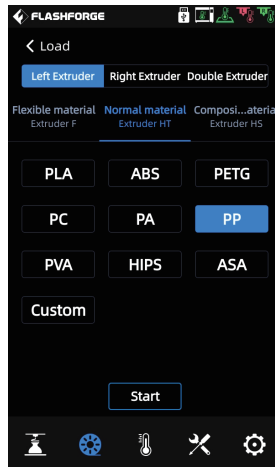
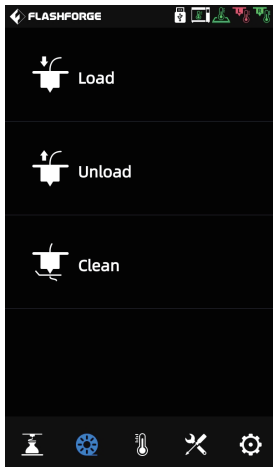

3. Click the  -[Load] on the screen, select the corresponding filament for each extruder, start filament feeding, and operate following the screen prompts.

## 2.2 Equipment Calibration

The equipment includes the following leveling and calibration operations:

Manual mode: Z-axis calibration, X,Y-axis calibration, expert mode calibration.

Auxiliary (Assist) mode: Sensor calibration, automatic leveling.



**ATTENTION**

**Before the equipment leaves the factory, the extruder sensor calibration has been set, so it is unnecessary to operate again.**

The equipment has been leveled and calibrated before leaving the factory, so it is generally unnecessary to calibrate again. However, the leveling plane may be damaged due to the vibration generated during transportation. It is recommended to perform a Z-axis calibration before printing.

**Please proceed in the following order:**

1. Click the  -[Level and Calibration] on the touch screen;
2. Select manual mode for Z-axis calibration;
3. Perform Z-axis calibration and operate following the screen prompts.

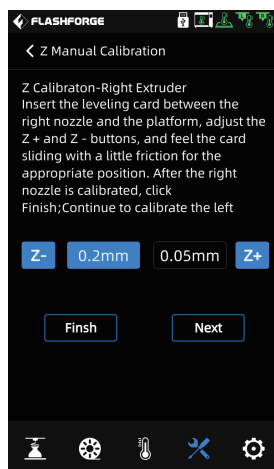
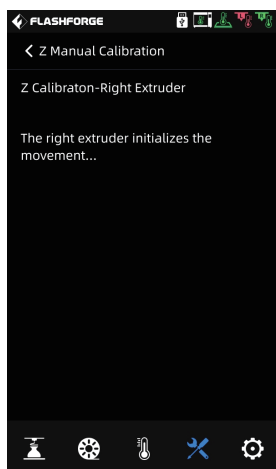
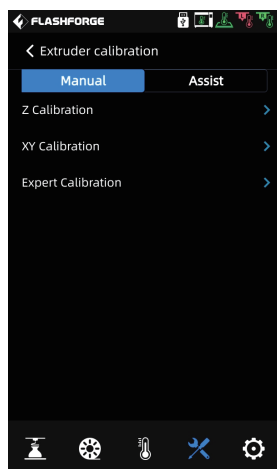

## 2.3 Internet Connection

### 2.3.1 Wired Network Connection

- 1) Plug the network cable into the network cable interface on the back of the equipment.
- 2) If the  icon appears in the upper right corner of the screen, it indicates that the equipment is successfully connected to the network.



### 2.3.2 Wireless Network Connection

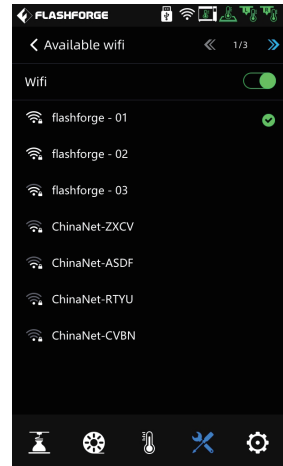
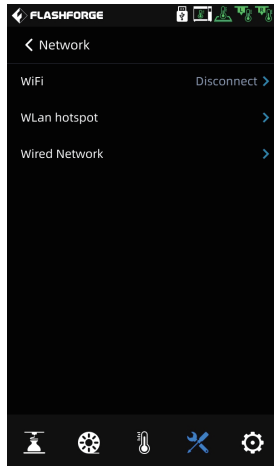
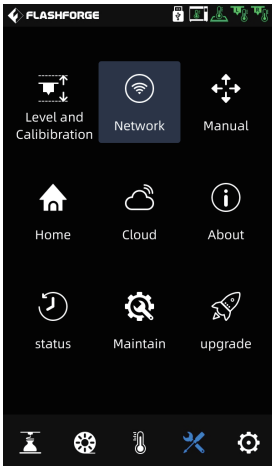

**ATTENTION**

Make sure Wi-Fi is installed before connecting to the wireless network, otherwise the wireless signal will be affected.



- 1) Click the  -[Network] on the touch screen, and select the "WiFi".
- 2) Click to connect to the corresponding wireless network. If the  icon appears in the upper right corner of the screen, it indicates that the equipment is successfully connected to the network.

# 3. Software Installation

**Method 1:** Find the FlashPrint software installation package in the USB flash drive and select the corresponding system version for installation.

**Method 2:** Download the latest slicing software from the official Chinese website ([www.sz3dp.com](http://www.sz3dp.com)) or the official English website ([www.flashforge.com](http://www.flashforge.com)) for installation.

## 3D printing process:

Get the model file. - Slice it with the slicing software. - Transfer the file to the printer for printing.

# 4. First Printing

## 4.1 File Transfer: Wi-Fi Transfer

Import the file to FlashPrint for slicing, select the Creator 4 to connect to the machine (or by entering the IP address or by auto-scanning, while the IP address can be viewed in the [About] of the equipment). After slicing is completed, send the file directly to the printer for printing.

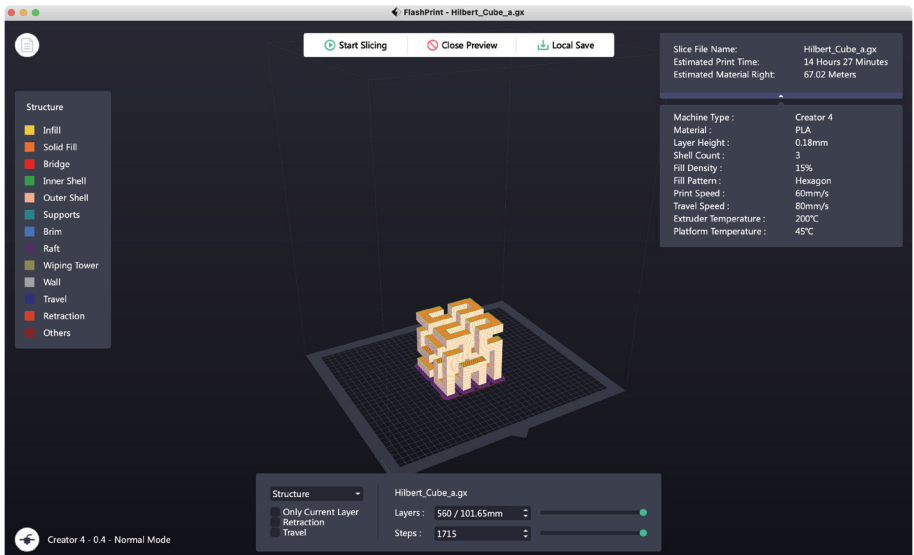

## 4.2 Printing via a USB Flash Drive

The equipment can perform printing via a USB flash drive: save the sliced file to the USB flash drive, insert the USB flash drive into the equipment, and select the corresponding file to print.

## 4.3 Printing via FlashCloud

### Printing via FlashCloud

1. Enter the FlashCloud website, register your account, and then you can log in and use it after the email activation.

FlashCloud: <https://cloud.sz3dp.com>

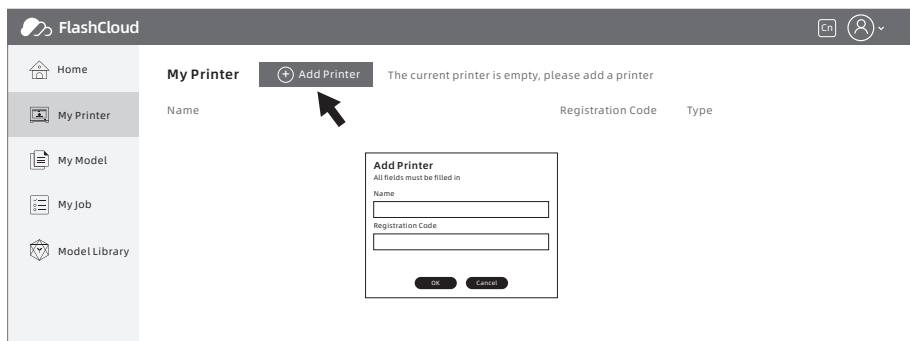

2. Click the [My Printer]-[Add Printer].

Fill in the registration number (cloud registration code) on the "Add Printer" page, and name the printer. After clicking the "OK", these information will appear in the FlashCloud interface of the printer.

## 4.4 Model Removal After Finishing Printing

### Warning

- When removing the model from the build plate, please pay attention to the need to wait for the platform to cool down before operating. At this time, you can check the temperature icon on the status bar of the screen to confirm the platform temperature. The green icon indicates that the platform temperature is lower than 50°C, then you can operate it safely.
- The matching gloves can be used when removing the model, and attention must be paid to the high temperature of the equipment.



After finishing printing, lift the lock latch on the front of the platform plate upwards and rotate it 90 degrees, take out the whole platform plate, and bend the platform plate to remove the model.

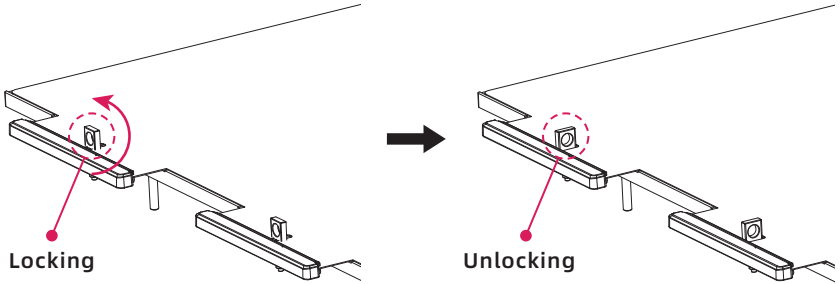

Remove the model and put the platform plate back into the equipment again. Operate as follows:

1. Install the flexible steel plate on the platform plate with the four snap hooks inserted at the rear end (note that they should be inserted on the inside of the snap hooks);
2. Rotate the lock latch 90 degrees and press the flexible steel plate.

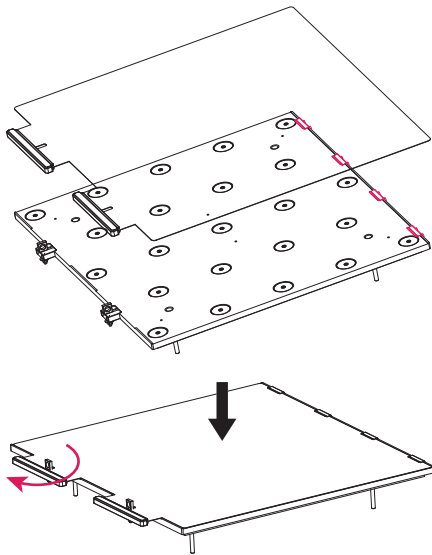

# 5.Equipment Configuration and Operation

---

## 5.1 Normal Mode

When the equipment uses a single extruder to print, set in the normal mode in the slicing software; The right extruder printing model is preferred by default. Users can also select suitable extruders to print according to actual needs. The model can be modified by moving, rotating and scaling. Click the [Start Slicing], select the corresponding printing material, and click the [Slice] and the sliced file can be generated.

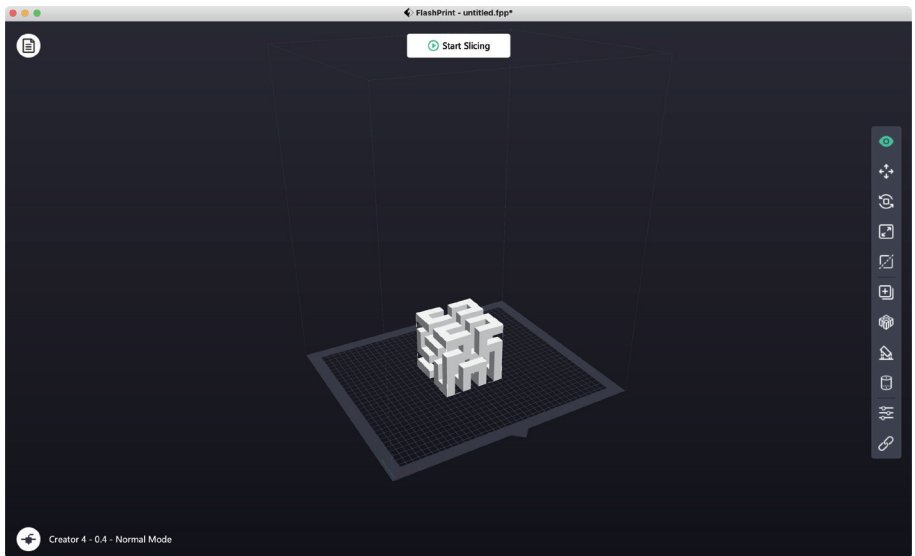

## 5.2 Dual-extruder Printing Mode

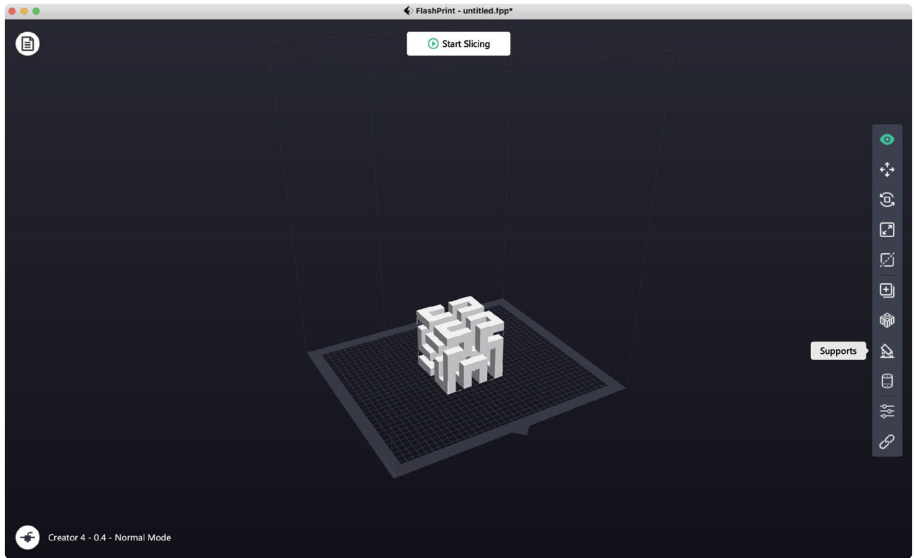

When printing dual-color/dual-filament models in the dual-extruder printing mode, please make sure that the nozzles are in contact with the anti-oozing plate, which will prevent the nozzles from oozing during the printing process; When printing single-color models, a single extruder is automatically used as the printing extruder by default if the user has not set the dual-extruder printing mode in advance.

The following settings can be made when printing dual-color / dual-filament models:

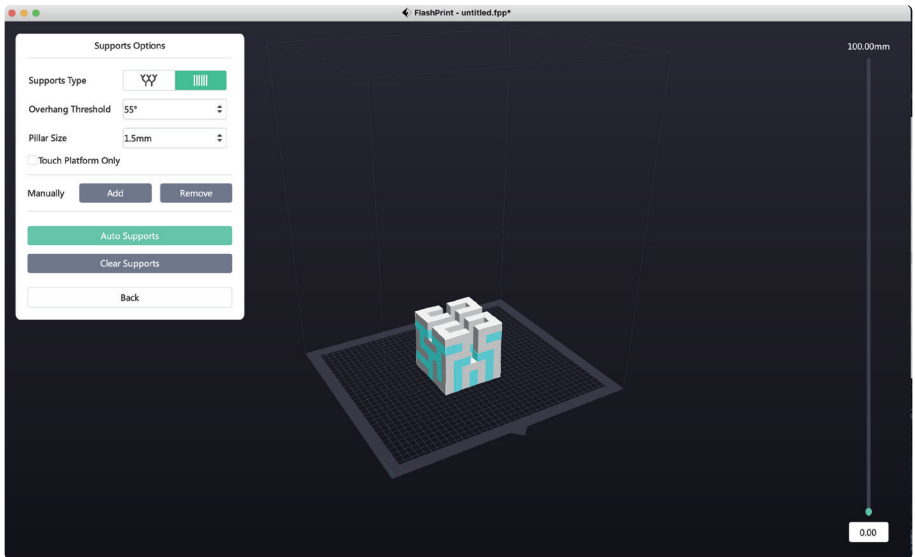

1. Load the model;



- 2. Click the  icon and select the support type as  ;
- 3. Click the [Auto Supports];

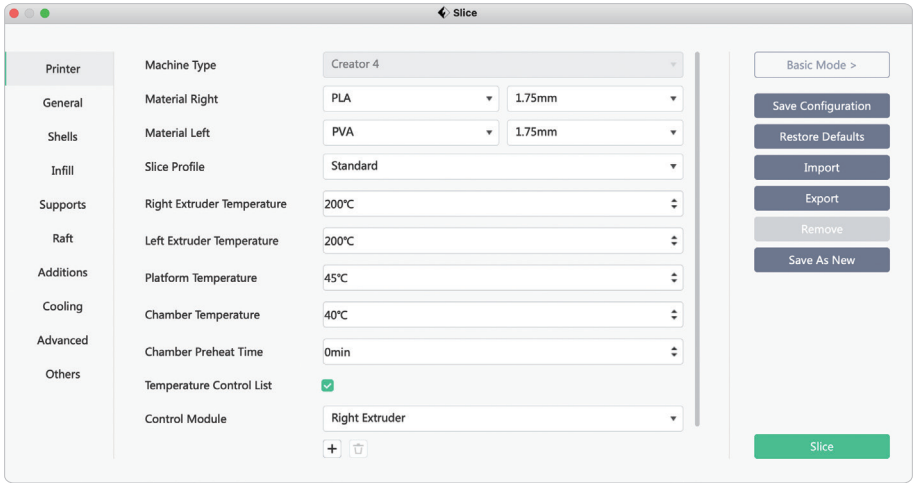

4. Click the [Start Slicing] to enter the parameter configuration screen;
5. Select the configured filaments (for example, Creator 4 PLA+PVA);
6. Click the [Slice].

**⚠ ATTENTION** By default, the equipment prints the support and model with the same extruder. If different filaments are used for support (such as printing PVA support with the left extruder and printing PLA model with the right extruder), select the left extruder in the support options.

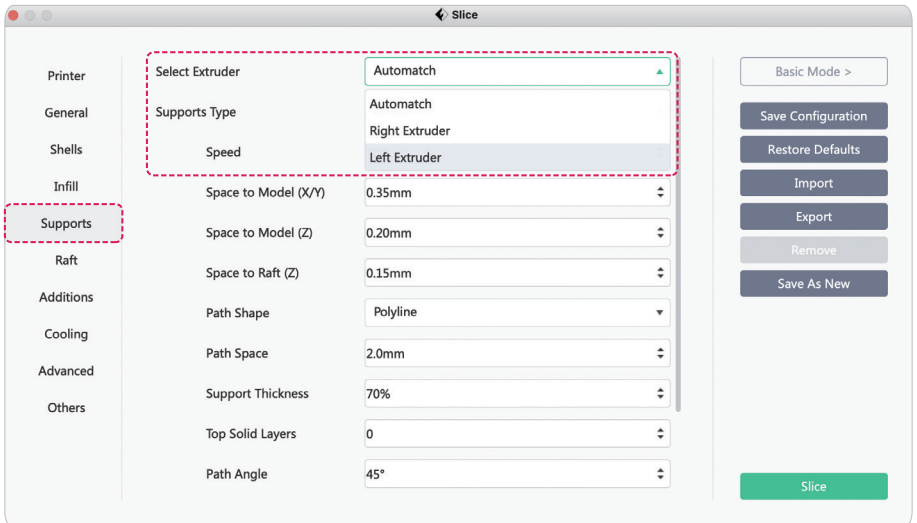

## 5.3 Mirror/Duplicate Mode

When you need to print two identical or mirrored models, just choose the mirror/duplicate mode in the slicing software. In this mode, the left and right extruders will print the models at the same time (**Note: only models with X-axis less than 183mm are supported in the mirror/duplicate mode**).

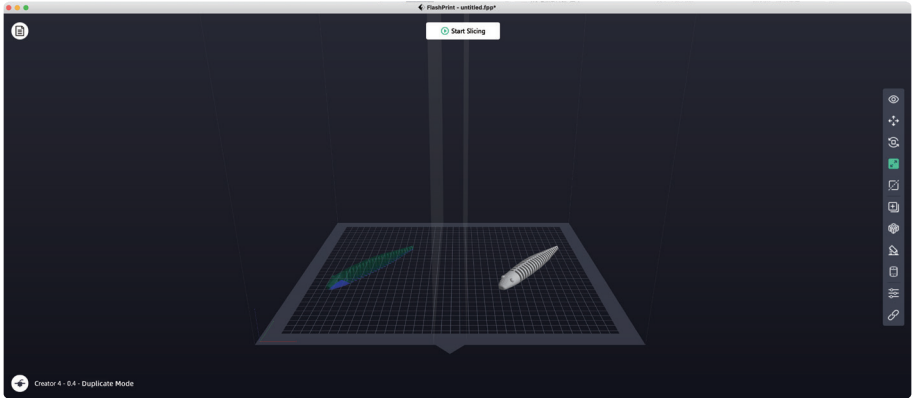

### Compensation layer in the mirror/duplicate mode

Mirror/duplicate mode: Since the heights of the left and right extruders are different after installation, the software will automatically add a compensation layer to compensate for the height difference when slicing, so that the printing heights of the left and right sides are consistent. Z-axis calibration is based on the right extruder, and the height difference between the left and right extruders is recorded.

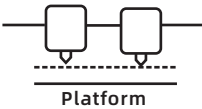

When the distance between the right extruder and the platform is smaller, the left extruder prints the compensation layer.

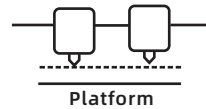

When the distance between the left extruder and the platform is smaller, the right extruder prints the compensation layer.

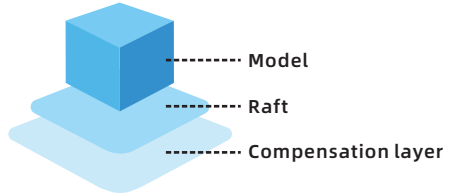

When the height difference is less than 0.2mm, the compensation layer will not be printed.

The compensation layer is printed first, and it is easy to be removed by adhering to the raft. If the raft printing is not added, the compensation layer will be directly applied to the model, which is difficult to remove.

## 5.4 Filament Configuration

Creator 4 series is equipped with two independent extruders;  
 Creator 4 series contains three types of extruders, which can support different filaments separately.



**Extruder-F**  
 180-265°C  
 2.85mm



**Extruder-HT**  
 200-320°C  
 1.75mm



**Extruder-HS**  
 265-360°C  
 1.75mm

Different types of equipment are equipped with different types of extruders:

Creator 4F	Creator 4A	Creator 4S
Extruder-F	Extruder-HT	Extruder-HT/Extruder-HS
Suitable for printing flexible filaments	Suitable for printing engineering filaments	Suitable for printing composite filaments
TPU85A-95A	PLA/ABS/ASA/PETG/PC, etc.	PACF/PAGF/PET-CF, etc.

Please refer to the table below for the combination of independent dual-extruder extrusion filaments.

**Soluble filament combination:**

Left extruder	Right extruder
PVA	PLA
PVA	NYLON
HIPS	ABS
HIPS	ASA
HIPS	PC
HIPS	PETG
HIPS	HIPS

PVA: Soluble in water.

HIPS: Soluble in limonene.

**Insoluble filament combination:**

Left extruder	Right extruder
PLA	PLA
ABS	ABS
ASA	ASA
PC	PC
PA	PA
PETG	PETG
PA-CF	PA-CF
PA-GF	PA-GF

### **⚠ ATTENTION**

As carbon fiber or glass fiber material is with strong strength, please use extruder-HS for printing this kind of material. The extruder is configured with a 0.6mm-nozzle by default; Carbon fiber composite materials are easy to cause blockage, so it is not recommended to use a 0.4mm-nozzle for printing this.

## Storage of filaments such as PVA/PA/PACF

- As PVA is water-soluble and highly water-absorbent, and filaments will soften after absorbing water, it will easily cause printing failure. During printing, it is necessary to place desiccant in the filament bin, and it is recommended to keep the humidity of the filament bin within 15%; Humidity status can be viewed on the screen.
- PVA will soften when the temperature is higher than 50°C, so it is not recommended to dehumidify it during the chamber-heating state when printing PVA.
- PA/PVA/PACF all need to be stored in a sealed and dry environment. After finishing printing, it is recommended to store the filaments in a drying box.
- Filaments are easy to cause stringing and oozing when being exposed to moisture, which will cause poor printing quality of models.

## 5.5 Filament Parameter Setting

In order to obtain high-quality printing effect, different printing filaments require different parameter settings, and Flashforge will configure the corresponding printing parameters in the slicing software. If filaments of other brands are used, the characteristics of the filaments corresponding to different filament brands will be different, which may involve fine adjustment of parameters. You can use the expert mode to adjust different parameters when slicing. The following are some adjustment suggestions for reference only:

- Thickening the height of the first layer and increasing the filament extrusion amount of the first layer are beneficial to the adhesion of the first layer.
- When printing small models with PLA (or the printing environment temperature is lower than 25°C), it is recommended to set the raft temperature to 40°C.
- When printing large models with PLA (or the printing environment temperature is lower than 10°C), it is recommended to set the raft temperature to 50°C.
- Make sure to close the equipment door and front door when printing models with ABS.
- When printing partial and small models, different printing speeds can be set in the slicing software according to the layer height.
- If you need to strengthen the partial part of the model, different filling amounts can be set according to the layer height.
- If the model is required to feature strong performance, it is recommended to select 100% filling.
- If the support is easy to break, it is recommended that the thickness of the support should be more than 90%.
- If the support is difficult to remove, it is recommended to increase the Z-axis clearance of the support.
- If you need to improve printing efficiency, you can increase the layer thickness.

## 5.6 Removal Method of Water-soluble Support Material

Models using PVA as the support material require some subsequent treatment after finishing printing. Place the models in water to dissolve the PVA support.

### 1. Submerge the model in water

Place the model with PVA support in water and the PVA will slowly dissolve. This process can be quickened by using the following methods:

- Warm water will decrease the dissolving time. If PLA is used for the printed model, please ensure that the water is no hotter than 35 °C, otherwise the PLA may be deformed.
- Use stirring/running water to decrease the dissolving time. Moving water enables the PVA to dissolve more quickly.
- You can also speed up PVA dissolution by placing the model in water for approximately 10 minutes, then removing most of the support with pliers and placing the model back in the water.

### 2. Rinse with water

After PVA supports are totally dissolved, rinse the model with water to remove any excess PVA.

### 3. Let the model dry

Let the model dry completely and apply additional post-processing to the model if necessary.

### 4. Disposal of waste water

As PVA is a biodegradable material, therefore disposing the waste water afterwards is easy. The waste water can be disposed down the drain. After disposal, run hot water from the tap for approximately 30 seconds to remove any excess saturated PVA and to avoid longer-term clogging issues.

## 5.7 Camera Connection

1. Please remove the camera cover before using the camera;
2. Turn on the camera switch;
3. After the equipment is connected to FlashPrint, the real-time video screen can be viewed in the FlashPrint-[Multi-Machine Control].



# 6. Equipment Operation Interface Introduction

**ATTENTION** The firmware will be upgraded from time to time. Please refer to the actual display screen for the interface. The following is only a brief introduction of functions.

## 6.1 Printing Screen

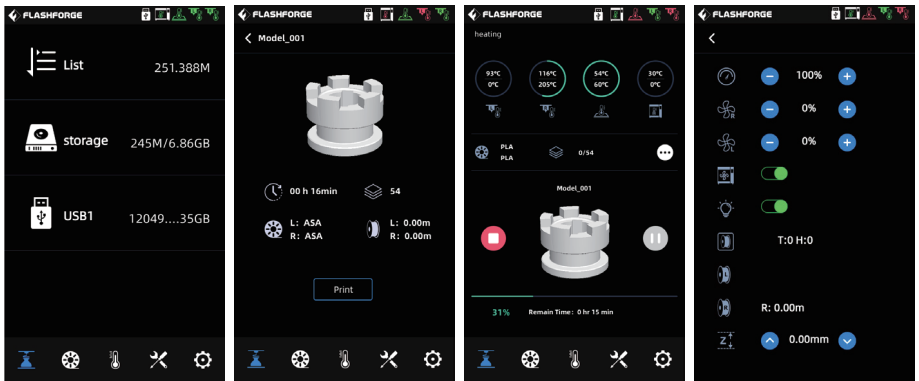

Some parameters can be adjusted during printing. Click the  icon for the control of the printing speed, fans and lights.

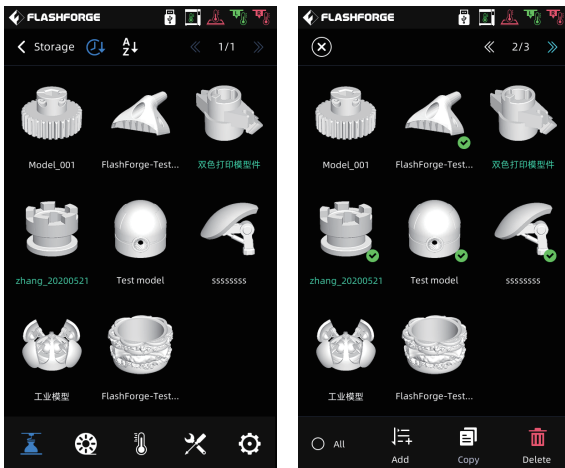

After finishing printing a file, if the color of the file name in the list changes, it means that the file has been printed; If you want to delete a file in memory, please long press the file in the file list, and then select it and click the [Delete].

## 6.2 Filament Screen

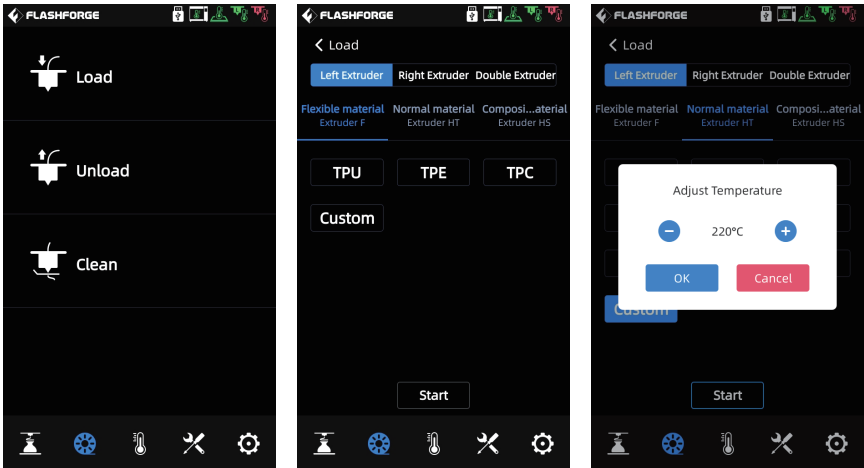

The filament screen includes: [Load], [Unload] and [Clean].

- During filament feeding and withdrawing, users can set according to the filament to be actually installed. If the currently required filament is not in the screen, users can customize the filament and set the required temperature for filament feeding.
- Filament cleaning: When the filaments printed in the last two times are different, please perform filament cleaning. In this way, it will avoid the situation that the filament is carbonized thus causing blockage or is not extruded due to different melting temperatures of the filaments. When switching from a high-temperature filament to a low-temperature filament, this operation must be performed; For example, when you need to switch it to PLA material after printing with PC material, it is necessary to clean the PC material from the nozzle, so it is necessary to set the temperature required for melting the PC material until all the PC material is extruded from the nozzle and there is no residue left in the nozzle.

## 6.3 Preheating Screen

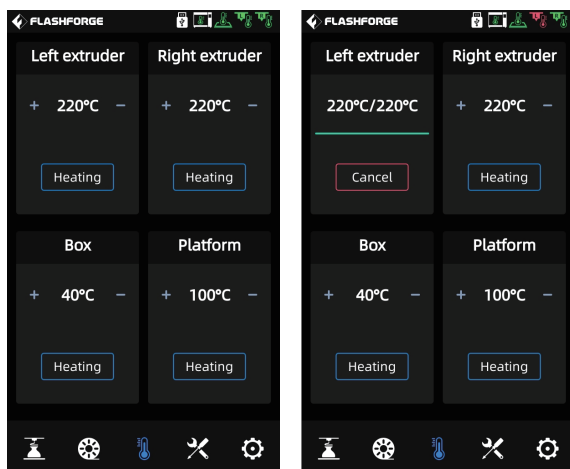

The temperature of the extruder, chamber and platform can be set in advance as required on the preheating screen.

## 6.4 Tools Screen

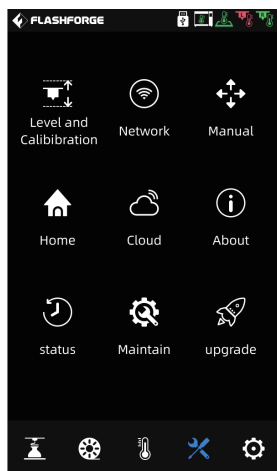

The tools screen includes:

[Level and Calibration]:

[Manual] (Manual calibration): Z-axis calibration, X,Y-axis calibration, expert mode calibration.

[Assist] (Auxiliary calibration): extruder sensor calibration, automatic leveling.

[Network]: Here you can connect the wireless network, wired network and hot spot.

[Manual] (Manual control): Here you can manually move the X,Y,Z axis of the equipment.

[Home]: Here you can make each axis of the equipment return to the zero position.

[Cloud]: Here you can connect to the FlashCloud.

[About]: Here displays the basic information about the equipment.

[status]: Here displays the running status of the equipment.

[Maintain] (Maintenance): Here lists some maintenance items. If users encounter any problems, you can check here.

[upgrade]: Here is for the firmware upgrade. You can upgrade to the latest firmware of the equipment when the wireless network is connected.

## 6.5 Setting Screen

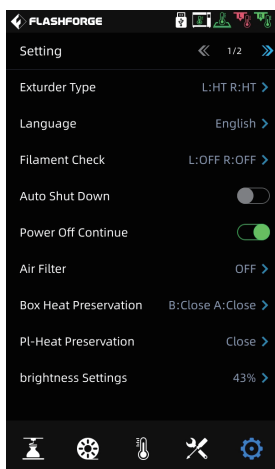

The functions can be turned on or off on the setting screen.

- [Extruder Type]: The selection of the extruder type is related to the setting of the filament feeding and printing temperature, so be sure to select the extruder that matches the equipment installation.
- [Filament Check]: When the filament detection function is turned on, the equipment will stop printing when the filament runs out in the middle of printing.
- [Auto Shut Down]: When the automatic shutdown function is turned on, the equipment will automatically shut down after finishing the model printing.
- [Power Off Continue]: When the resuming printing after recovering from power failure function is turned on, if the power is suddenly off during printing, the equipment will automatically store the current printing position data, and continue the printing of the current model after the power supply is recovered.
- [Air Filter]: When the air filtration function is turned on, the fan on the back of the equipment starts; The front of the fan is equipped with HEPA filter cotton and activated carbon filter cotton, which can filter the dust and peculiar smell produced during printing.
- [Box Heat Preservation]: When the chamber insulation function is turned on, the temperature insulation time before and after printing can be set. Due to the characteristics of some materials, it is necessary to maintain the thermal balance before and after printing.
- [PI-Heat Preservation]: When the platform insulation function is turned on, the platform insulation time before and after printing can be set. When in the transition state of removing the model, avoid increasing the time of reheating when the temperature drops. When this function is turned on, the platform remains the heating state when the model is removed after printing. Please pay attention to the high temperature and avoid burns.

# 7.Maintenance

## 7.1 Maintenance Screen

You can query the current encountered problem on the maintenance screen.

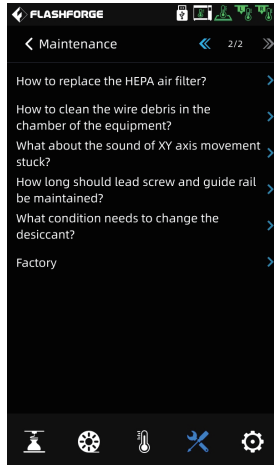
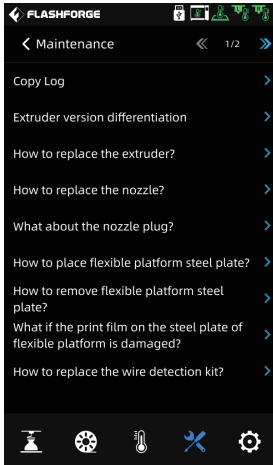

## 7.2 Extruder Maintenance Introduction

### 7.2.1 Extruder Parts Diagram



**ATTENTION**

When operating the extruder, the power supply must be disconnected.

Left Extruder Assembly

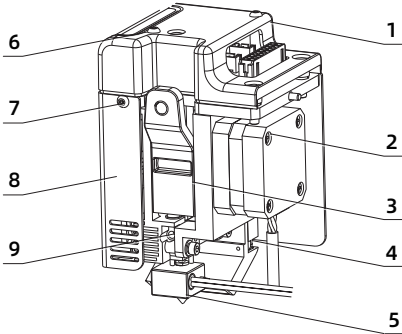

Right Extruder Assembly

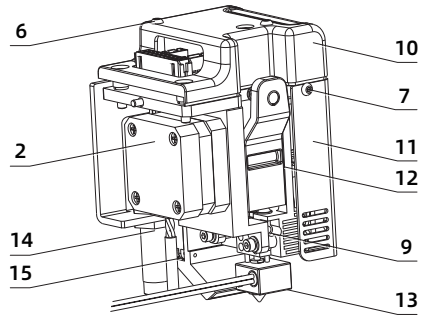

- |   |                                      |
|---|--------------------------------------|
| 1. Left Extruder Upper Cover                    | 9. M4*3 Screw                        |
| 2. Filament Feed Motor                          | 10. Right Extruder Upper Cover       |
| 3. Left Handle                                  | 11. Right Extruder Sheet Metal Shell |
| 4. Cooling Fan                                  | 12. Right Handle                     |
| 5. Left Nozzle Assembly                         | 13. Right Nozzle Assembly            |
| 6. M3*30 Hexagon Socket Button Head Screw M3*30 | 14. Proximity Sensor                 |
| 7. M3*6 Hexagon Socket Button Head Screw M3*6   | 15. Cooling Fan                      |
| 8. Left Extruder Sheet Metal Shell              |                                      |

As shown in the above figure, the device is equipped with two extruders. According to the direction, they are called the left extruder and the right extruder. The parts and numbers related to the extruder assembly are consistent, but they are left-right symmetric. Please note that they cannot be used interchangeably at will.

### 7.2.2 Clogged Nozzle Cleaning

#### Method 1:

1. Heat the nozzle to the matching temperature of the filament used;
2. Pull out the filament guide tube, press the handle and pull out the filament;
3. Observe whether the head of the filament is bent. If so, cut off the bent part of the head of the filament, then insert the filament guide tube and the filament into the nozzle again, and click the [Load], and the nozzle will re-extrude the filament.

#### Method 2:

Heat the nozzle and insert the unclogging pin tool into the throat and the nozzle to extrude the filament inside the nozzle.

### Method 3:

If the method 1 and method 2 operations are ineffective, please replace the nozzle assembly. Click the [Maintain (Maintenance)]-[How to replace the nozzle?], and operate following the instructions on the screen. That is, as follows:

**⚠ ATTENTION** After checking the steps shown on the screen, power off the equipment before replacing the nozzle assembly.

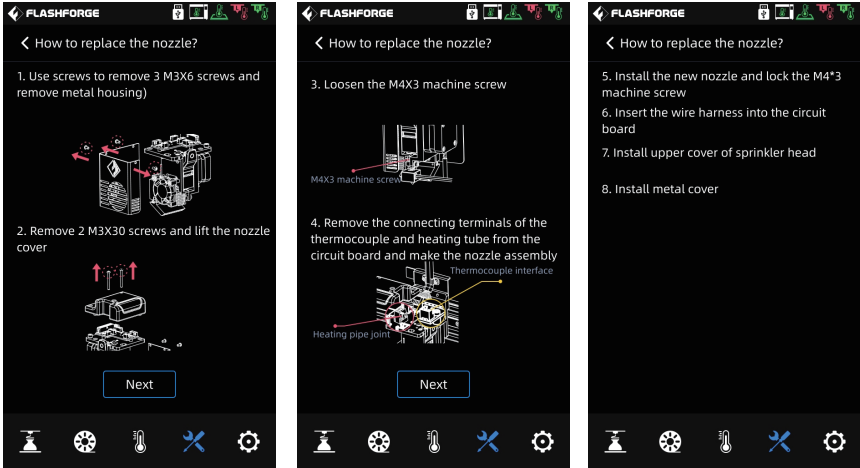

### 7.2.3 Platform Flatness Calibration

Generally, users do not need to operate this. When the flatness of the equipment that has undergone some calibration or the automatic leveling compensation is still incorrect, it may be that the flatness of the platform has been damaged during installation. At this time, the initial platform leveling is required.

**♥ Special note** For this operation, you can contact Flashforge after-sales personnel for remote assistance in the calibration.

Please operate as follows: There are 4 leveling points in total.

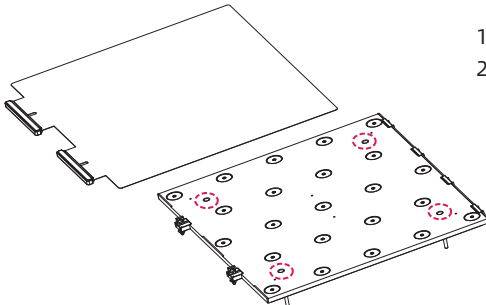

1. Remove the flexible steel plate;
2. Loosen (note that the screws only need to be loosened, and do not need to be removed) the four locking screws on the platform;

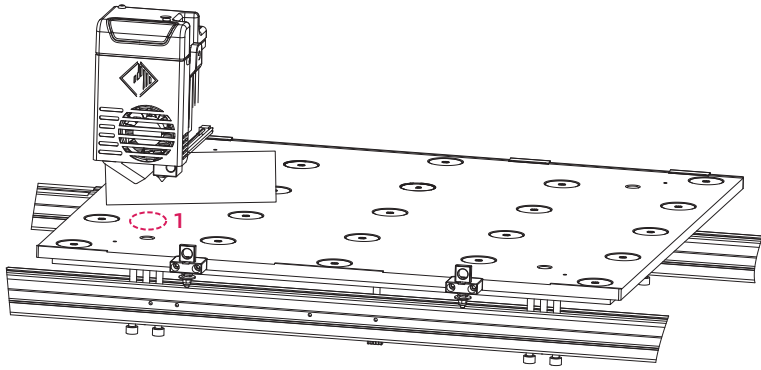

3. Click the  -[Manual] on the screen and click the Z-axis rising arrow to manually move the extruder to the Position 1 (that is, above the leveling screw); Stop when the Z axis rises to the position where it will touch the nozzle; Insert the leveling card between the platform plate and nozzle, and adjust M5\*60 left screw under the profile at the same time; When feeling resistance during sliding the leveling card, it indicates that it is the appropriate position. Then adjust the right screw under the profile in the same way as the left screw;

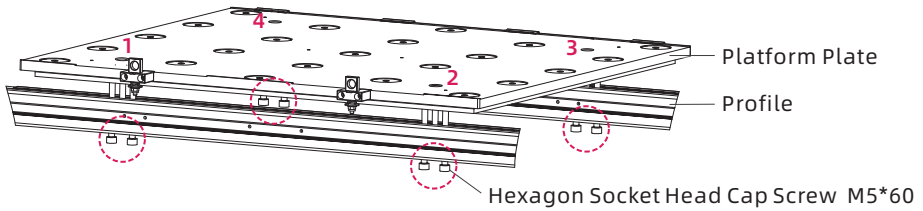

4. Move the extruder to the Position 2 manually, and be sure to move it slowly. If the extruder scratches the platform, it is necessary to adjust the M5\*60 left screw under the profile at the Position 2, slide the leveling card to confirm that the distance between the nozzle and the platform is appropriate, and then adjust the right screw;
5. Adjust the Position 3 and Position 4 in the same operation method in turn;
6. After finishing the adjustment of the four positions, please tighten the four screws above the platform to lock the platform.



# 8.Q&A

---

## Q1. Clogged nozzle issue.

Answer: Click the  -[Maintain (Maintenance)].

## Q2. How to replace the nozzle?

 **ATTENTION** Please shut down and cut off the power before replacing the nozzle. Please do not operate with electricity.

Answer: Click the  -[Maintain (Maintenance)].

## Q3. Is there a need to calibrate the extruder after replacing the nozzle?

Answer: No.

## Q4. Click to start printing the model, and the extruder moves, but there is no filament extrusion at the beginning of printing.

Answer:

1. Observe the filament guide tube to confirm whether the filament enters the extruder; If not, please click the [Load] button again until the filament is extruded from the extruder;
2. Check whether the nozzle is clogged. If so, please check the Q1 for the solution.

## Q5. The relative position between the nozzle and the platform is too high (far away from the platform) or too low (touching the platform) during printing. How to level it?

Answer: Click the  -[Level and Calibration]-Z calibration, and operate according to the screen prompts.

## Q6. Can the filaments of other brands be used?

Answer: The filaments of other brands can be used. But it needs parameter adjustment and configuration due to the temperature difference of different filaments.

## Q7. Is the equipment compatible with all AC inputs?

Answer: The equipment is compatible with 220V-240V or 100-120VAC input voltage. If the input voltage is different between different regions, it cannot be directly powered on, that is, for countries with 110VAC voltage, it needs to purchase the equipment corresponding to 110VAC voltage.

## Q8. Can the equipment automatically shut down after finishing printing?

Answer: Yes.

## Q9. Is printing ABS material safe?

Answer: ABS material will release toxic gases during heating, so it is recommended to open the HEPA air filter for filtration during or after printing. If conditions permit, it is recommended to place the equipment in an open environment for printing. It is recommended to print PLA nontoxic materials in children's activity places.

**Q10. The printed model is warping or not sticking well.**

- Scheme 1: Increasing the platform temperature can effectively alleviate this problem, as the high temperature can increase the adhesion between the platform and the model.
- Scheme 2: Choosing to add a raft when slicing the model can effectively alleviate this problem.
- Scheme 3: Apply glue.
- Scheme 4: If the clearance between the nozzle and platform is too large, the clearance can be reduced accordingly, and the clearance can be adjusted by using extruder calibration in the expert mode or leveling and calibration function.
- Scheme 5: Confirm whether the platform is laid flat. The leveling and calibration function can be used, and it is recommended to perform a full-process automatic leveling.

**Q11. Must a raft be added when printing a model?**

Answer: Not necessary. When printing the raft, the filament extrusion amount is larger and the printing success rate is higher. Under the condition of raft heating, the adhesion between the model and the platform plate increases, which makes the model adhere to the platform well when printing, and also increases the printing success rate.

**Q12. After inserting the USB flash drive, the print file can not be found, and the screen displays all as folders.**

Answer: The format of the U disk is incorrect. The equipment supports FAT32 file system. Please format the U disk into FAT32 format.

**Q13. What is the expert mode during calibration?**

Answer: When in the expert mode, the clearance value can be directly adjusted and a whole calibration process can be skipped. The expert mode is suitable for experienced users. For details, please refer to the expert mode explanation in the screen calibration instructions.

**Q14. Wi-Fi connection failure.**

Answer:

1. Please check whether the Wi-Fi name contains special characters. If so, please modify it and try again.
2. Please check whether the password contains special characters. If so, please modify it and try again.

**Q15. Matters needing attention in updating the firmware.**

Answer: Please do not disconnect the power and the network when downloading or updating the firmware to prevent the update failure.

**Q16. Why is the boot screen white?**

Answer: If the start-up sound can be heard, please replace the screen or the flat cable; If not, please contact our after-sales personnel.

**Q17. Equipment crash and black screen (blank screen) occur during printing.**

Answer: Please reboot the equipment, copy the firmware log and send it to Flashforge after-sales engineers for troubleshooting.

# 9.Help and Support

---

Flashforge professional after-sales service personnel and salesmen are on standby for you at any time, and are very willing to help you solve any problems you encountered during use. If the answer can not be found from the user guide, you can go to our official website to search for the solution of your problem, or contact us by phone.

Some explanations and solutions of common problems can be found in our official website. Many of your problems can be solved in [www.flashforge.com](http://www.flashforge.com), the official English website of Flashforge.

The Flashforge after-sales team can be reached by email or phone from 8:00 a.m. to 5:00 p.m. from Monday to Saturday to solve your problems. In case you contact us during off-duty time, your inquiry will be answered the next following business day immediately. We are sorry for any inconvenience caused.

**Note: Due to the replacement of different filaments, there will be a small amount of impurities left in the extruder, which will cause the clogged nozzle issue. As this can be solved by just unclogging it, this is not a quality problem. If users encounter this problem when using the equipment, please contact our after-sales personnel, and complete the unclogging operation under the guidance of our after-sales personnel.**

After-sales Service Tel: +86-400-886-6023

E-mail: [support@flashforge.com](mailto:support@flashforge.com)

Address: No. 518, Xianyuan Road, Wucheng District, Jinhua City, Zhejiang Province, China

**Note: Please provide the product serial number which is the barcode at the back of the printer before contacting our after-sales personnel.**





Follow us

## **Zhejiang Flashforge 3D Technology Co., Ltd.**

Address: No.518 XianYuan Road, Jinhua City, Zhejiang Province, China

Service Hotline: +86 579 82273989

[support@flashforge.com](mailto:support@flashforge.com)