

# INSTRUCTIONS FOR LAYING

## WHERE CAN I LAY FAUS FLOORING?

FAUS flooring can be laid on concrete, vinyl, linoleum, wood, tiles, marble or stone, and basically on any kind of subfloor. Do not lay this kind of flooring in saunas, commercial laundries or in areas with generally very damp floors or affected by extreme temperatures.

Follow the instructions for floors laid in occasionally damp areas such as kitchens and bathrooms.

## HOW DO I GO ABOUT CALCULATING THE NUMBER OF BOXES OF FAUS FLOORING I NEED?

Calculate the total floor surface (multiplying the length x breadth of the room) being sure to calculate all surfaces to be floored in addition to the main section. To know how many boxes you need, divide the total number of square metres obtained by the number of square metres in each box and add an extra 10%. If the length of the room is longer than 12m, you must place an expansion profile to limit the space as shown (picture N°1).

## PRECAUTIONS TO BE TAKEN BEFORE LAYING FAUS FLOORING

Leave the FAUS® planks at the temperature of the room in which they are going to be laid, in a horizontal position and in closed boxes, for a minimum of 48 hours before laying them (picture N°2).

Carefully open the boxes from the back in order not to damage your FAUS planks and don't use a cutter (picture N°3). The flooring must be laid immediately after the box has been opened. Carefully check the planks before their final laying. No claims for faulty planks will be accepted after their installation.

If in doubt about dampness, check the floor by taping plastic film directly onto it. Contact your distributor if the plastic shows signs of humidity after 24 hours. Moisture measurement should not exceed the 2.5% according to the CM method. For radiant floors it should not exceed the 1.5%.

Remove all the skirting boards for proper installation and leave the expansion joint between 10/12 mm (picture n°4).

Extra precaution should be taken during the cut of the planks, for a close fit of the design in the products that incorporate the Interactive Innovations MultiDirection Continuity and FastDesign Continuity.

## TOOLS REQUIRED TO LAY FAUS FLOORING (picture N°5)

Make sure that you have all of the necessary tools for laying the flooring:

- Hand, electric or jig saw.
- Measuring tape, split-level, pen or pencil, cutter and adhesive tape.
- Spacing wedges and special laying wedges.

You will need the following tools to lay the flooring round pipes, beneath door frames and for the laying of skirting boards and/or mouldings:

- Crowbar, mitre box, screw-driving machine, electric saw, off-square and white glue D3.

## CARE AND CLEANING

We recommend that you use a vacuum cleaner and dry mop for everyday cleaning (picture N°6). If this is not enough, you can use a damp cloth or mop in warm water, always well wrung out. We recommend a non-abrasive detergent for resistant stains. Take care not to use soapy products of any kind.

We recommend that you apply felt pads to furniture supports. Use door mats at all entrance doors, inside and out.

Do not attempt to install and uninstall the floor more than three times.

In the improbable case of damaging a plank, consult your FAUS authorised dealer.

Do not use steam machines or any other robot containing water.

## TIPS FOR PERFECT FLOOR LAYING

• It is extremely important to use polyethylene (plastic) film for its protection against dampness (picture N°7). We therefore recommend that you fix it in place before starting to lay the floor, no matter what the kind of subfloor at hand (except organic).

• It is extremely important not to lay the floor flush against any fixed point in the room. Always remember to leave space for the expansion gap (picture N°8).

• Laminate flooring must be allowed to float, meaning that it must not be screwed to anything or nailed to the floor beneath it. It is also advisable not to place heavy objects on it either as doing so could cause it to lose its ability to float.

• Carefully follow the installation instructions.

• Remember that laminate flooring is the last step in building a house and must only be laid once you have finished painting, fitting windows, etc.

• Remind that for the products that incorporate the Interactive Innovations MultiDirection Continuity, it is essential to install the planks to a 50% in order to get a randomized design.

• The chevron designs have plank A and plank B and should be placed as row A + row B, creating an arrow effect, and following the micro bevel continuity.

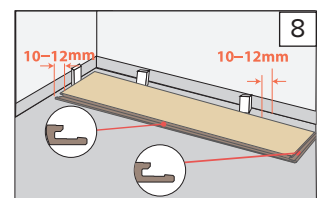
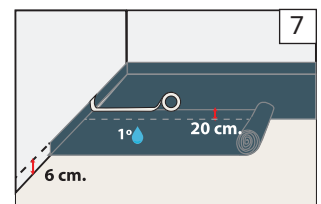
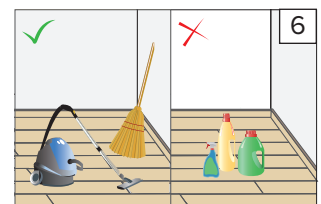
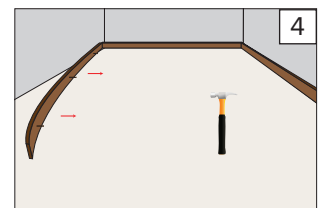
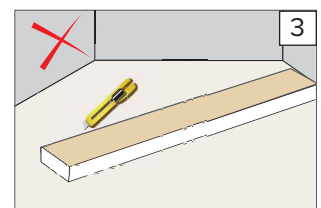
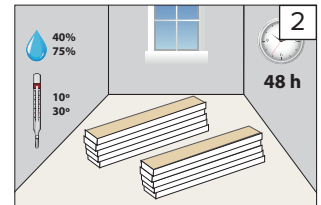
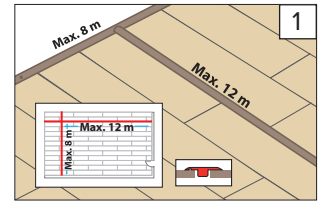

## LAYING IN KITCHENS, BATHROOMS AND OTHER AREAS SUBJECT TO DAMPNESS

Do not place cabinets on the laminate flooring, which should stop just short of the cabinets, leaving an expansion gap of 0.6 to 1.3 cm. We recommend that you use a silicone sealer (sealer Clic Seal FAUS) to fill the expansion gaps on all potentially damp surfaces serving as bases for ice-making machines, dish washers and sinks.

Remember that it is advisable to apply felt pads to the levelling wedges of washing and drying machines before switching them on.

Always use end profiles and silicone sealers at bathroom doorways to separate the bathroom floor from the rest of the floor.

Remove toilets before laying the laminate flooring. Leave an expansion gap of 0.6 to 1.3 cm round the edge of the toilet stand. Once the floor has been laid, fill the gap with high-quality silicone sealer (sealer Clic Seal FAUS) (picture N°9). In the event of water spillage, clean and dry within 24 hours (within 48 hours if ClicSeal has been used). WWW.FAUS AQUA -0

Also use silicone sealer to fill the expansion gaps running round the walls of the room and all fixed elements, such as cabinets, pipes, door frames, sinks and toilets.

To prevent water from filtering through the floor in damp areas, apply silicone sealer to the expansion gaps round the perimeter (this will not prevent the laminate flooring from expanding).

Do not lay laminate flooring in rooms with subfloor drainage.

To ensure that the flooring will withstand the dampness in all rooms, apply the silicone sealer as per the procedure indicated in the laying instructions.

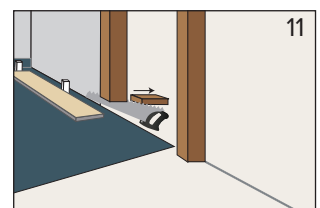
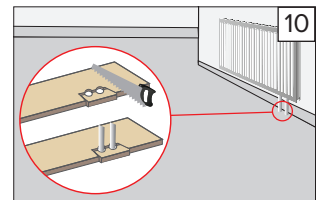
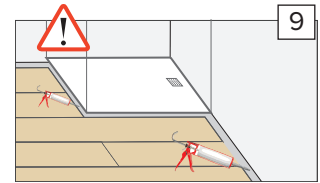

## OTHER LAYING TIPS

- When laying planks round pipes, bore a hole measuring 2 cm more than the pipe in question for expansion purposes. Cut the plank diagonally with respect to the centre of the holes. Stick the cut parts together and join the pieces with a crowbar (picture N°10).

- The floor must be laid beneath door frames. Place a single FAUS plank on the polyethylene foam, touching the door frame, and cut the frame at that height. Always remember to leave room for an expansion gap (picture N° 11).

- Substituting planks either to improve the final appearance of the surface covered or to change planks damaged by potential laying errors is very easy. To reach the plank in question, you will have to lift the last complete row of planks laid slightly (approx. 3 cm) in order to separate the lengthwise edge of the previous row. Having removed the complete row, separate the individual planks, one at a time, until they are all free. Proceed in the same way (lift the complete row approx. 3 cm, remove the complete row and separate it plank by plank) until coming to the plank you want to replace. Change the plank and continue laying the floor.

# INSTRUCTIONS FOR LAYING

## GENERAL INSTRUCTIONS FOR LAYING FAUS FLOORING

### STAGE 1

This flooring can be laid on concrete, vinyl, linoleum, wood, ceramic, marble or stone, simply follow the instructions. All carpeting must be removed beforehand. All existing joints and/or skirting boards must be removed (picture N°1).

### STAGE 2

Clean the subfloor on which the floor is to be laid. Make sure that it is level, defect-free and dry. It is extremely important that your floor be laid on a good subfloor. Unevenness for planks of 30/40 cm. should not exceed the 2mm per meter. For those planks of 60 cm, it should be less than 3mm per 2 meters.

Concrete subfloors must always be covered with polyethylene film (plastic) to keep dampness at bay. Always remember that concrete subfloors must have been laid at least a month before starting to lay your FAUS® flooring. This said, in the case of very damp subfloors, it is always better to contact your distributor for technical instructions. We similarly recommend that all concrete-based tile, marble or stone subfloors be covered with polyethylene film (plastic).

Do not use polyethylene film (plastic) when laying flooring on wood, plywood or any kind of organic subfloor.

Remove any wood or other organic flooring glued to the concrete before laying the FAUS flooring.

Place the FAUS UNDERLAY, made of 1m + polyethylene foam, covering the entire area. Ensure that the end of one piece and the start of a new one overlap at least 20 cm and that the edges cover up to 6 cm of wall surround. Seal the joints with tape (picture N°2). The Underlay, in addition to its levelling function, reduces the acoustic vibrations caused by footsteps

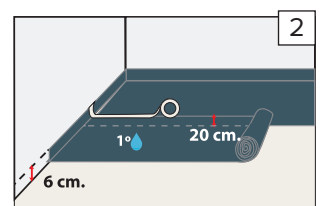
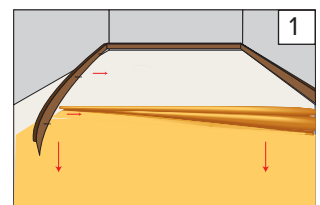

**VERY IMPORTANT!!**  
LAY DOWN THE PLASTIC FILM AS VAPOR BARRIER, OVERLAPPING EDGES BY 20 CM UNSING ADHESIVE TAPE AND PLACE IT ABOUT 6 CM UP THE WALL

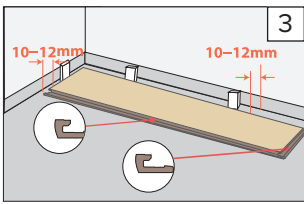

and knocking.

### STAGE 3

For correct floor installation and a perfect finish, FAUS® recommends that you lay the planks according to the way the light enters the room. Wherever possible, we recommend that the longest side of the planks be laid parallel to the source of entering light or to the longest wall in the room.

Always leave an area for expansion (expansion gap) around the walls of the room and all fixed elements, such as pipes, furniture, door frames, etc.

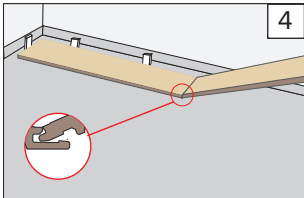

Use shaping wedges bigger than 10 mm to leave room for expansion gaps round all of the walls in the room.

WARNING: expansion gaps must measure 10-12 mm round the walls and fixed elements alike (picture N° 3).

### STAGE 4

Measure the width of the room and divide it by the plank width. If the width of the last row of planks is less than 6 cm, cut the first row of planks lengthwise to make them narrower and try to make the width of the first and the last rows the same.

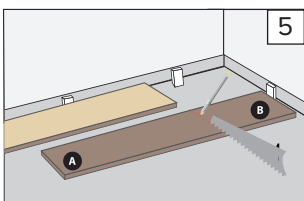

### STAGE 5

Start in the left-hand corner. Place the first plank (picture N°3) with the tongue side (the less machined edge) towards the wall and insert the shaping wedges between the wall and the plank. We recommend that you cut off the part jutting out from the plank to avoid problems with the expansion gaps. Place the next plank at an angle to the first, pushing the two shorter sides together and press both planks downwards. Follow the same procedure all along the row (picture N°4). Mark and cut the last plank, with the decorative surface upwards if using a manual saw, and downwards if using an electric saw, (picture N°5). Start the second row with the piece of plank left over from the first row. If the leftover piece measures less than 40 cm, cut a new plank in half and use one of the halves to start a second row (in the case of ceramic tiles, the first and last piece of each row should measure approx. 30-40 cm in length, i.e. a complete tile) (picture N° 6).

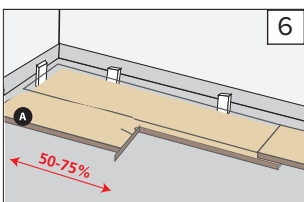

While the flooring can be laid without using tools of any kind, you can use special mounting wedges if you wish. The process is extremely similar in both cases. The wedges are simply an easy way of obtaining the correct angle of the planks with the previous row. If you don't want to use wedges, simply lift the last plank laid slightly to permit the one which you are currently laying to slot into place.

To place the second and following rows, you have 2 installation options: the angular system or the snap system.

- Angle system (picture N°7a): Place the short side of the second plank at an angle to the first one, making it as flush as possible with the plank in the first row (approx. 2 mm), pressing lightly downwards to adjust it. lightly lift (33 mm for planks of 30 cm and 50 mm for planks of 40 cm; the wedges and a bit of practice will make it easier) the previous plank and lightly tap the one you are currently laying with your hand. Once it is installed against the previous row (drawing no. 7), press lightly downwards for assembly (picture N°7b).

#### ANGLE SYSTEM

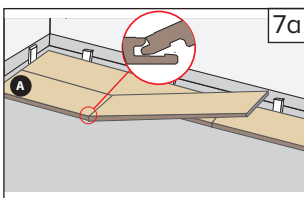

- Snap system (picture N° 8a): Place the first plank in angle, inserting the long end into the plank of row 1. Push down slightly to insert the plank until it snaps into place. Then, with the aid of a mandrel, tap the hammer gently, in order to slide the blade until the click fits with the lateral blade (picture No 8b). The piece should be approximated as much as possible to the end, exactly 3 mm from the previous one, as it matches with the projection of the transverse male. We recommend using a part piece to facilitate the guidance of the longitudinal part not completed.

### STAGE 6

For surfaces of over 100 m<sup>2</sup>, 12 m in length and 8 m in width, an expansion gap will be required also recommended for connecting doors. To maintain correct expansion gap spacing, we recommend that you remove the dovetailed edging (picture N° 9).

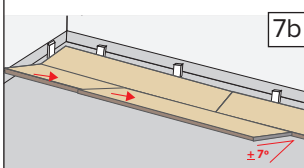

### STAGE 7

To adjust the width of the last row of planks, place the last plank on top of the one before last. Mark the outline of the wall on the last plank using another one as a guide and saw it accordingly (Ilustración N° 10). Remember that you must always leave a space for the expansion gap.

#### SNAP SYSTEM

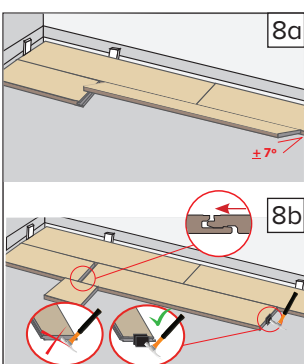

Remove the wedges and install the skirting boards without nailing or screwing them into the ground. Always apply a drop of silicone sealant to the base of the mouldings that you are going to use in order to join them to the surface of

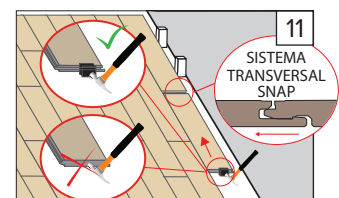
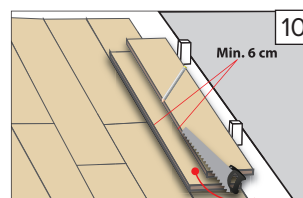
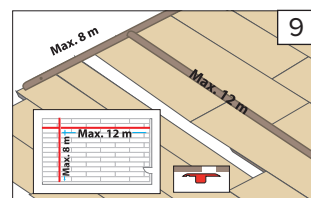

---

# INSTALLATION OF FAUS LAMINATE FLOORING

---

Laminate flooring is especially recommended for installation in rooms heated by hydronic radiant floors.

## INSTALLATION OF 'FAUS' LAMINATE FLOORING ON RADIANT FLOORS

It is important that the radiant floor be properly installed and that the concrete base is sufficiently dry, which is why the work of the floor installer is vital.

The Radiant floor installer should prepare a written Protocol containing the following data regarding the heating system:

- Heating data, specifying temperature flows/currents.
- Maximum point of temperature flow/current reached in the entrance valve/uptake.
- Operational conditions and outdoor temperature when it is graduated.

The installer should record and note down a temperature curve of the area to be installed and for both stages - heating and cooling - pursuant to what is set forth under Standard DIN 4725 – Part 4 “Principles: radiant heating”.

The radiant heating pipes should be no more than 30 cm away from each other, to ensure even distribution of heat.

## CONCRETE

In order to start the installation of your laminate floor, it is important and vital that the concrete base be sufficiently dry. This aspect must be properly checked, whether the concrete is new or if it has been in existence for some time.

A first simple rule would be that prior to installing the laminate floor, the concrete must have undergone drying for at least 1 week per centimetre for a concrete base, up to 4 cm thick; and for 2 weeks per centimetre for concrete over 4 cm thick.

In any event, one must always hasten the concrete drying, regardless of the time of year, and one must also always check the following:

To hasten the drying of a radiant floor, a 2-stage drying cycle is recommended, according to the “Code of practice issued by the Association of Parquet and flooring technology” under the title “Preparatory measures to be taken prior to the installation of parquet and textile floor coverings in conjunction with under floor heating systems”. For recently applied concrete, one must gradually increase the temperature (5° C per day) for at least 2 weeks before application, and at least 21 days after the concrete has been installed.

## INSTALLATION OF THE LAMINATE FLOORING

Once we have made sure that the concrete is ready for installing the laminate floor, we start off by disconnecting the heating one or two days prior to the installation, in order to achieve a floor temperature of approximately 18° C.

We must also bear in mind the following:

The temperature on the floor surface should remain at about 18° C before (one or two days before), during and at least 3 days after installing the laminate floor.

Once 3 days have elapsed after installing the laminate floor the temperature should be gradually increased by about 5° C per day and without exceeding 28° C, which is the maximum admissible temperature. It is important that temperature increases occur gradually.

Any temperature changes must always occur gradually, whenever starting and finishing any working period of radiant heating, not just during the installation stage, but also during the whole useful life of the floor. Any forced temperature changes within a short period of time impairs the stability of laminate floors. Thus, both before and after any winter season, the floor undergoes a heating and cooling period that must carefully experience gradual temperature changes.

It is important for the environment inside the room not to be too dry during heating sessions. For temperatures ranging from 18-22° C, the relative humidity should be approximately 60 %. If it is too dry, an air humidifier is to be used.

**IMPORTANT:** Place the FAUS UNDERLAY, made of film + polyethylene foam, covering the entire area. Ensure that the end of one piece and the start of a new one overlap at least 20 cm and that the edges cover up to 6 cm of wall surround

## OTHER ASPECTS

During the heating session, the joints may open slightly and one should know that this is part of the process.

Any accumulation of heat under the carpets or due to lack of ventilation under the furniture should be avoided.

Never forget to leave expansion joints of at least 8 mm around any fixed element.

When using radiant flooring, it is crucial to limit the number of m2 of installations to 12 meters in length and 8 meters in width.