

3 Shelves Montessori Bookshelf Instruction Manual

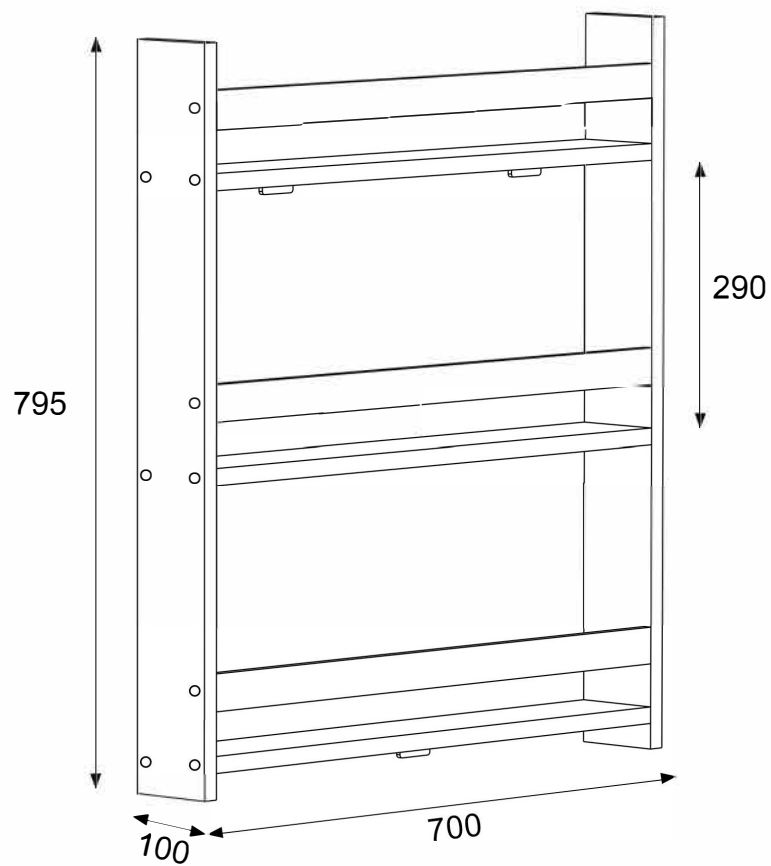
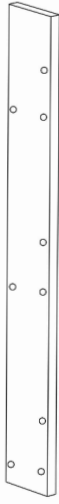
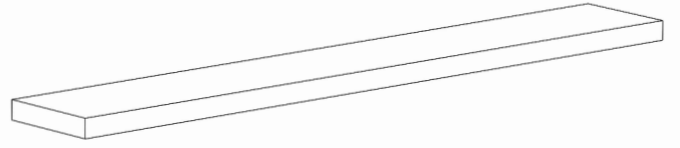
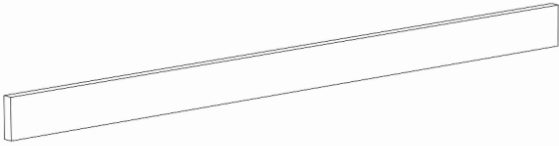
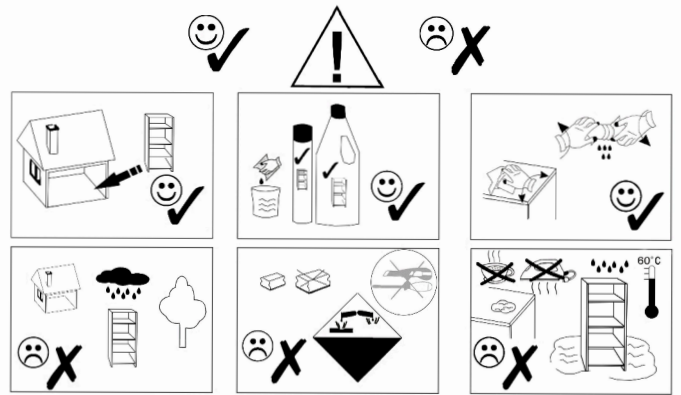

A**x2****B****x3****C****x3**

a x18

b x6

c x3

d x3

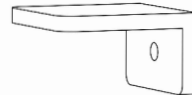
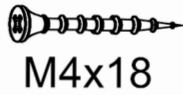
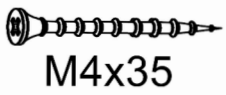

e x3

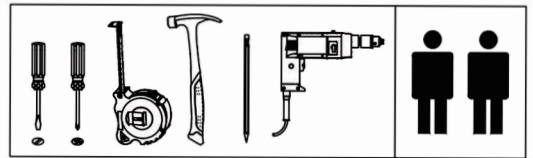
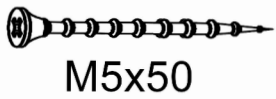

f x18

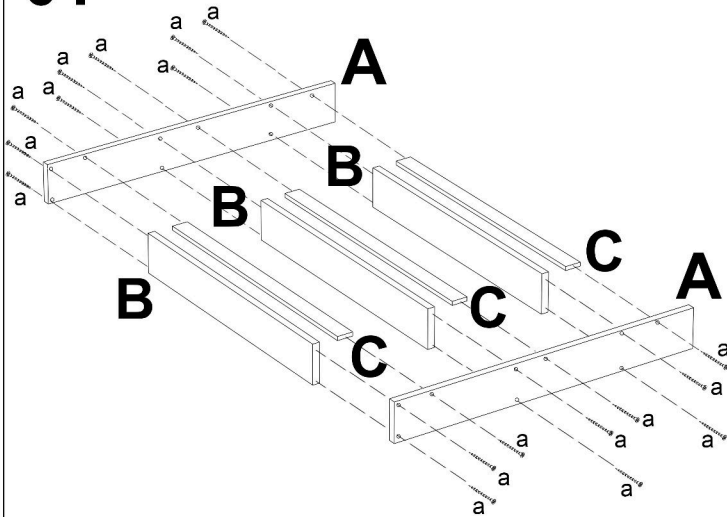

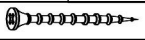

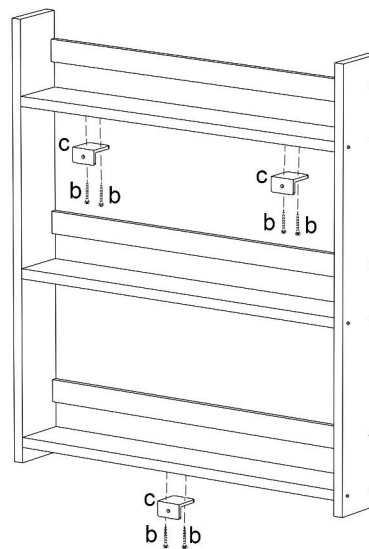
01

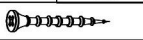
a	x18
	
M4x35	

02

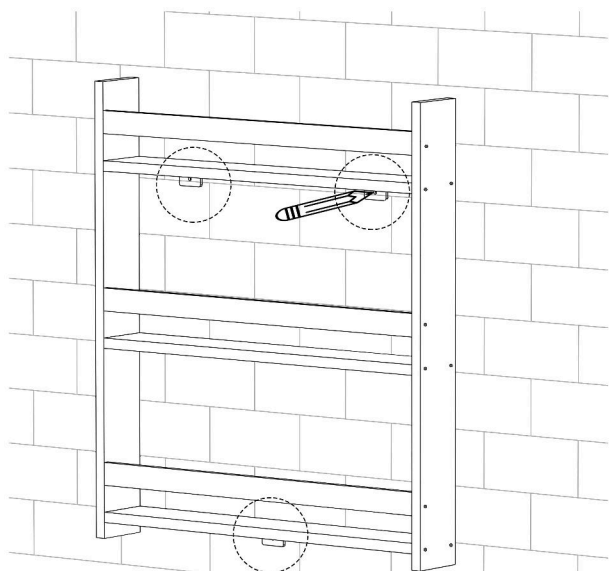
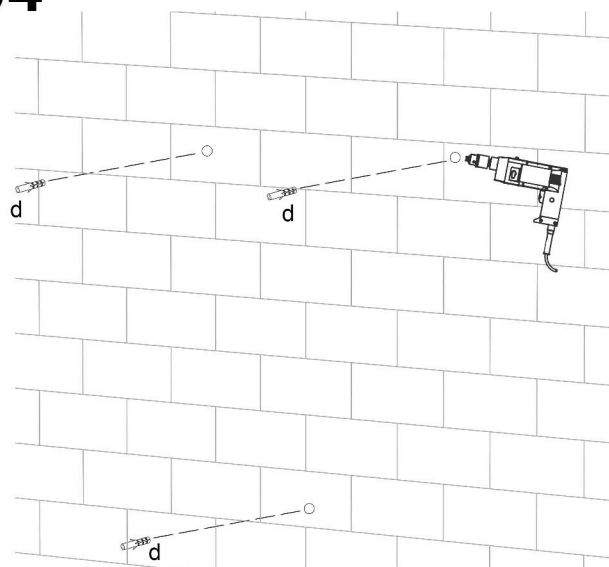
b	x6	c	x3
			
M4x18			

03**04**

d	x3
	

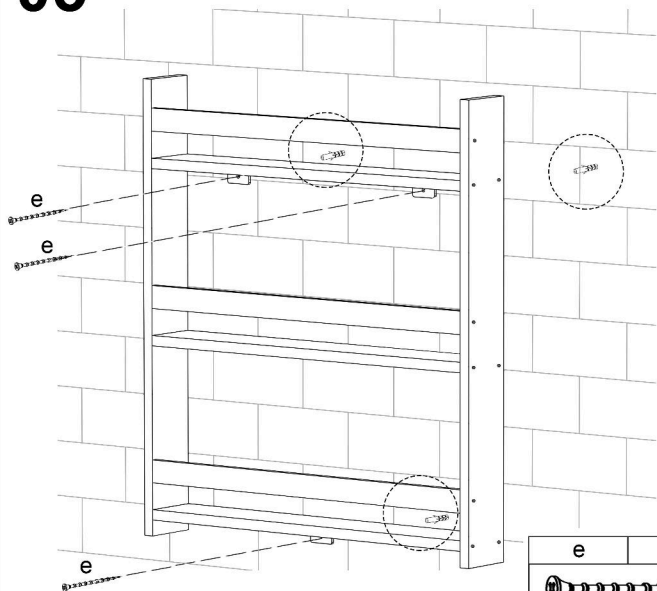
05

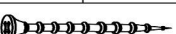
e	x3
	
M5x50	

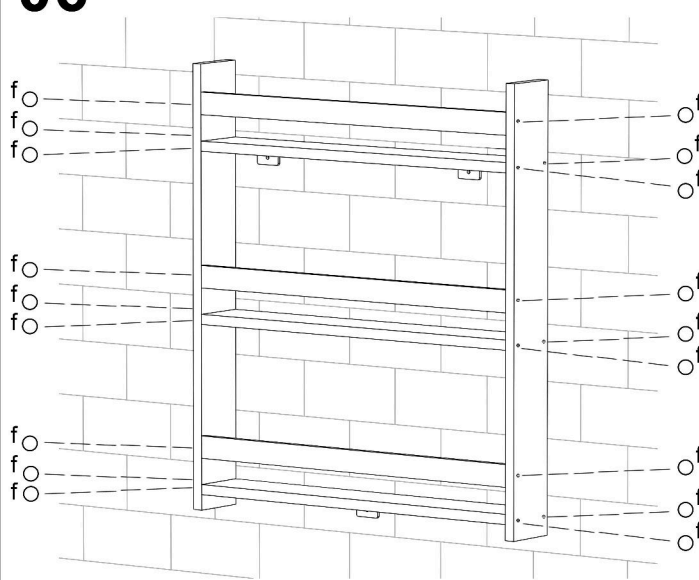
06

f	x18
