

# **Clip C Series -Thermal Imaging Attachment User Manual**

IRay Technology Co., Ltd.

## Contents

1. Description .....	1
2. Components and Controls.....	2
2.1 Components .....	2
2.2 Controls.....	3
3. Menu/Status Bar Icons.....	4
4. Specifications.....	5
5. System Function .....	7
6. Operation System.....	8
6.1 Power on / Power off .....	8
6.2 Standby Mode .....	8
6.3 Status bar.....	8
6.4 Navigation Menu .....	8
6.5 Advanced Menu .....	9
6.6 Blind Pixel Calibration .....	11
6.7 Compass Calibration.....	11
6.8 Image Calibration (Only for Attachment).....	12
6.9 Stadiametric Rangefinder (Only for Monocular).....	14
7. Accessory Equipment: Remote control/ App software .....	15
7.1 Bluetooth Remote Control .....	15
7.2 APP Software.....	16
8. Preventative Maintenance.....	17
8.1 Battery Installation.....	17
8.2 Product Cleaning and Maintenance .....	18
8.3 Safety Regulation.....	18
9. General Trouble Shooting.....	19
10. Appendix.....	20
10.1 User Interface Description .....	20

10.2 Product Dimensions .....	20
10.2.1 Boundary Dimension .....	20
10.2.2 Bottom Mounting Hole Size .....	21

## 1. Description

Clip C Series is a multifunctional thermal imager device equipped with two kinds of eyepiece that can be used either as a monocular or a front attachment as the infrared expansion device of white light. Different from the night vision device based on image enhancement, Clip C Series doesn't need external light source and isn't influenced by strong light exposure. It can be used in the night or bad weather conditions such as fog, rain, smog and can detect the objects through obstacles such as branch, tall grass, dense bushes and so on. Clip C Series has a wide range application including night hunting, observation and terrain orientation, search and rescue operations.



Fig. 1-1 Clip C Series thermal imaging attachment

## 2. Components and Controls



Fig. 2.1 Function introduction

### 2.1 Components

















No.	Name	Function description
①	Lens Cap	Protecting the lens and using for background correction
②	Objective Lens	——
③	Lens Focus knob	Used to adjust the focal length of objective lens to make the image to be the clearest when the image is indistinct.
④	Battery Compartment Cover	Using two batteries which are CR123, CR123A or 16340 to supply power.
⑤	Monocular Eyepiece Locking Ring	Fixing the monocular eyepiece on Clip C Series unit.
⑥	Eyepiece diopter adjustment ring	Adjusting the diopter of monocular eyepiece to suit different eyesight.
⑦	Eye Shade	——
⑧	Attachment's Eyepiece	Eyepiece as the infrared expansion attachment of white light sight
⑨	Bayonet-type ring of attachment's eyepiece	Used to lock the adapter ring between the white light sight and the attachment
⑩	Locking Ring of Attachment's Eyepiece	Locking the Attachment's eyepiece to Clip C unit.

⑪	Type-C Interface	Used for data communication and external power supply
⑫	Power(P) Button	Power on/Power off/Standby/Up/Left
⑬	Menu(M) Button	Entering menu/Parameter switch
⑭	Correction(C) Button	Shutter correction/Background correction /Down/Right

## 2.2 Controls

Operation in normal display mode			Operation in menu mode/calibration interface		
	Short Press	Long Press		Short Press	Long Press
<b>P (12) Button</b>	Standby/ Awaken	Power on / Power off	<b>P (12) Button</b>	Adjust parameter /Scroll up options	——
<b>M (13) Button</b>	Enter the Menu Navigation	Enter the advanced menu	<b>M (13) Button</b>	Function switch/Parameter selection★	Save and exit menu
<b>C (14) Button</b>	Shutter correction	Background correction	<b>C (14) Button</b>	Adjust parameter/Scroll down options	——
<b>M (13) Button + C (14) Button</b>	——	<b>Attachment:</b> Enter image calibration interface	<b>P (12) Button</b>	Up/Left shift	Up/Left quick shift
			<b>M (13) Button</b>	X/Y shift	Save and exit
			<b>C (14) Button</b>	Down/Right shift	Down/Right quick shift
		<b>Monocular:</b> Enter stadiametric rangefinder interface	<b>P (12) Button</b>	Increase the distance between measurement bars	Quickly zoom in
<b>M (13) Button</b>	——		Exit		
			<b>C (14) Button</b>	Reduce the distance between measurement bars	Quickly zoom out
★ When entering Navigation Menu, pressing it briefly to switch functions. When entering Advanced Menu, pressing it briefly to switch the parameter options.					

### 3. Menu/Status Bar Icons

	Screen lightness setup--four levels 
	Image mode: B(Black hot)、W (White hot)、R (Red hot)、C (Pseudo Color)
	E-zoom (Only for Monocular: ×1, ×2, ×4)
	Ultraclear mode
	Bluetooth option
	Bluetooth connected
	Video output option
	Video output on
	Battery type selection
	Reticle
	Blind pixel correction option
	Factory reset
	Battery capacity indicator
	Type-C power supply
	Orientation shift

## 4. Specifications

Model	CL42
Detector Parameters	
Detector Type	VOx Uncooled
Resolution	384*288
Pixel Size	17um
NETD	≤50mk
Frame Rate	50Hz
Optics Parameters	
Objective Lens	42mm
Field of View	8.9°×6.7°
Magnification	Attachment: 1×; Monocular: 2.9×-11.6×
Diopter Adjustment	-5D~+5D
Detection Range (Target size: 1.7m × 0.5m, P(n)=99%)	1540
Display Parameters	
Type	OLED
Resolution	1024×768
Electrical Parameters	
Battery	CR123×2
Power Consumption	<1500mW
Max. Battery Life	4h
External Interface	
USB Interface	Type-C
Video Output	PAL (RCA Port)
External Power	Type-C
Functions	
Digital Compass	√



Motion Sensor	√
Remote Control	Bluetooth
Stadiametric Rangefinder	Only for Monocular
Replaceable Parts	M18 Monocular Eyepiece
<b>Physic Parameters</b>	
IP Rating	IP66
Weight (without batteries)	<420g
Dimension	154mm×61mm×58mm
Adapter Ring	M52×0.75

## 5. System Function

- Quick conversion between attachment and monocular
- Quick mounting and removal of attachment
- Detection range beyond 1.5km
- 1024×768 high resolution OLED display
- Bluetooth remote control
- Four image modes – white hot, black hot, red hot, pseudo color
- Monocular digital zoom: ×1、×2、×4 (Only for monocular)
- Type-C interface power supply and data transmission
- PAL analog video output
- Build-in Bluetooth, compass, motion sensor
- IP66 protection level
- Compact size
- Light weight and great impact resistance

## 6. Operation System

### 6.1 Power on / Power off

Press and hold down **P (12)** button for 3s to start up the device and the image appears on the display screen. After 6s, the device is turned on.

Press and hold down **P (12)** button for about five seconds to shut down the device.

### 6.2 Standby Mode

Enter/exit the standby mode with pressing the **P (12)** button briefly for power saving.

### 6.3 Status bar

The status bar is located at the bottom of the screen, which shows information such as image mode, screen lightness level, bluetooth activated, E-zoom, video output activated, battery status.

### 6.4 Navigation Menu

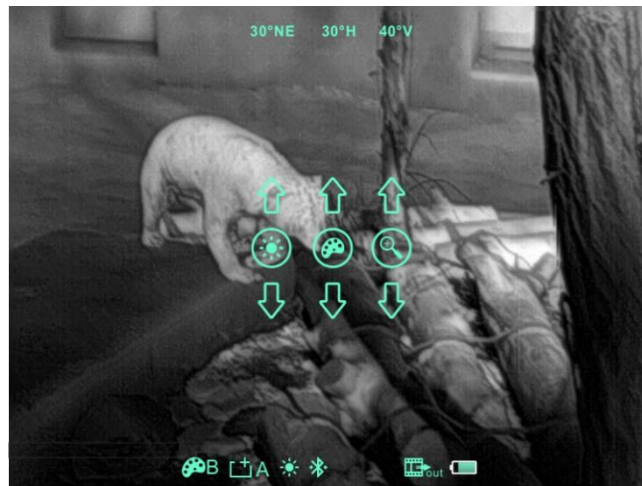

Fig. 6-1 Navigation Menu

In the normal display interface, press **M (13)** button briefly to switch the order of "none menu - screen brightness - image mode - electronic zoom - exit the navigation menu", and by pressing **P (12)** button and the **C (14)** key to adjust the parameters of each function. Navigation menu interface is as shown in fig. 6-1.

- **Screen lightness:** 1~4 lightness level;
- **Image mode:** W (White hot), B (Black hot), R (Red hot), C (pseudo color);
- **E-zoom (only for monocular):** ×1、×2、×4.

## 6.5 Advanced Menu

Press and hold down the **M (13)** button for three seconds to enter the advanced menu interface (fig. 6-2). The six functional options from top to bottom are Ultraclear mode, Bluetooth, video out, battery type, blind pixel correction, and factory reset. Please referring to table 6-2 for details.

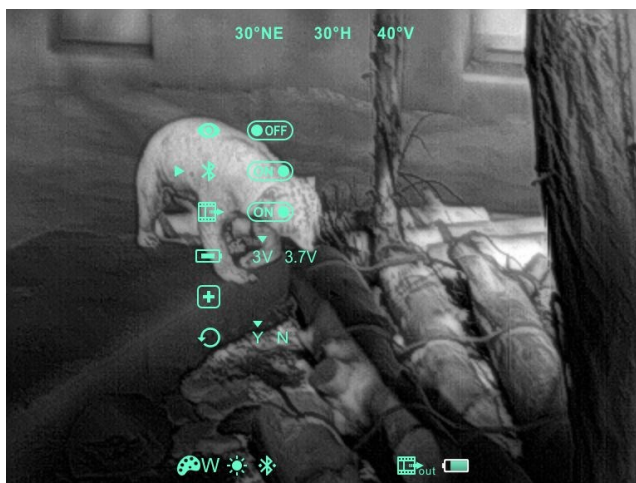









Fig. 6-2 Advanced menu interface

### Operations:

- In advanced menu mode, pressing **M (13)** button briefly to adjust the parameters of present option or enter the secondary menu.
- **P (12)** button is used to shift “up” or “left”. **C (14)** button is used to shift “down” or “right”;
- Press and hold down **M (13)** button for three seconds to exit advanced menu interface.

Table 6-1 Advanced menu function description

Icon	Name	Function	Description	Status
	Ultraclear Mode	Conversion of normal	In this mode, the image contrast is enhanced, which is	The icon displays at

		mode and Ultraclear mode	suitable for cloudy, rainy, foggy and other harsh weather conditions	the status bar.
	Bluetooth	ON/OFF	When Bluetooth is on, it can be operated with the bluetooth remote control or mobile phone APP (please search for connection by mobile phone within 1 minute, otherwise, the bluetooth will be automatically turned off ).	The icon displays at the status bar.
	Video Output	ON/OFF	Transfer the analog video in pal through the Type-C data cable.	The icon displays at the status bar.
	Battery Type	3V/3.7V	3.7v is selected for rechargeable batteries, and 3V is for normal dry batteries.	_____
	Zeroing Type	G1/G2/G3/G4	Up to four groups of calibration data can be stored	The icon displays at the status bar.
	Blind Pixel Correction	Calibrate the blind pixels on the image	Refer to 6-6	Blind pixel calibration interface (fig. 6-3)
	Factory Reset	Restore factory state	Y: Confirm, N: Cancel Press and hold <b>M</b> button to save and exit.	_____

## 6.6 Blind Pixel Calibration

- When entering the advanced menu, selecting the blind pixel calibration option and press **M (13)** button briefly to enter the blind pixel calibration interface (fig.6-3). A reticle will appear in the center of the screen.
- And then, moving the reticle up-down or left-right to select the blind pixel by pressing the **P (12)** button and **C (14)** button. Pressing **M (13)** button briefly to switch the orientation of X-axis (left-right) and Y-axis (up-down);
- After selecting the blind pixel, press **P (12)** and **C (14)** button at the same time to correct the blind pixels;
- Repeat the above operations to continue selecting blind pixel, and the status bar at the bottom of the screen will display the number of corrected blind pixel;
- When the correction is done, press and hold **M (13)** button to exit the blind pixel correction.



Fig. 6-3 Blind pixel correction interface

## 6.7 Compass Calibration

- Press and hold **M (13)** button to enter advanced menu;
- In advanced menu mode interface, rotating Clip C 360 ° three laps around the optical axis to enter the compass calibration interface as rotating direction shown in fig. 6-4.



Fig. 6-4 Rotate direction

- And then, a three-axis coordinate system (shown as fig. 6-5) will appear in the center of the screen, ten plane calibration method is used to rotate Clip C. It will automatically exit and complete compass calibration after 30s.
- During the calibration process, press **P (12)** button briefly to exit the compass calibration interface at any time.



Fig. 6-5 Compass calibration interface

## 6.8 Image Calibration (Only for Attachment)

When the device is installed on the white light sight tool as an infrared extension component, if the reticle of the white light sight is not in the center of the infrared image that the image calibration function can be used to shift the infrared image to ensure the position consistency between the white light image and the infrared image.

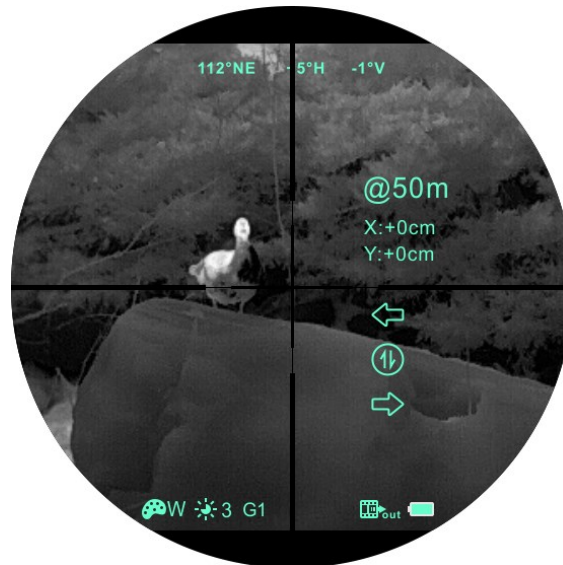

Fig. 6-6 Image calibration interface

**Operation:**

- Please finish the calibration of the white light sight before mounting Clip C.
- Installing Clip C Series on the white light sight and repeat the calibration. Then aiming at the target at 50 meters and shooting. Measuring the horizontal distance and vertical distance between the bullet hitting point and the aiming point afterwards.
- In normal display mode, press the **M (13)** button and **C (14)** button for 3s at the same time to enter the image calibration interface. Pressing **P (12)** button or **C (14)** button briefly to move the position of infrared image and long press to achieve quick shift. Pressing **M (13)** button to switch the orientation of X-axis (left-right) and Y-axis (up-down) while the moving distance is displayed synchronously above the icon. (as shown in figure 6-5)
- When the calibration is done, long press **M (13)** button to save and exit the calibration interface.

**Note:** Before zeroing function performs, please confirm the storage location of this. i.e., Selection of the type of zeroing. (Refer to 6.5 for details)



## 6.9 Stadiametric Rangefinder (Only for Monocular)

Stadiametric rangefinder is only for monocular mode that can estimate approximate distance to an object of known size.

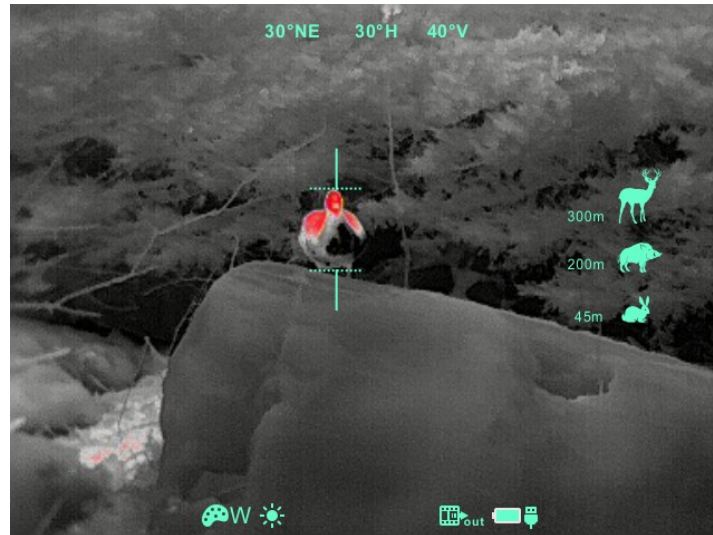

Fig. 6-7 Stadiametric rangefinder interface

- In normal display mode, press and hold the **M (13)** button and **C (14)** button for 3s at the same time to enter the stadiametric rangefinder interface (fig. 6-7).
- You will see the following on the display: two measurement bars, icons of three reference objects and respective distances of each.
- There are three pre-set reference objects:
  - **Hare** - height 0.2m
  - **Wild boar** - height 0.8m
  - **Deer** - height 1.7m
- Aiming at the target, and then adjust the distance between the measurement bars by pressing **P (12)** button or **C (14)** button until the target matches entirely between the two bars. **P (12)** button is used to increase the distance and **C (14)** button to reduce the distance.
- The distance to the object is automatically recalculated while moving the measurement bars and displayed on the left of the three reference objects.
- Exit rangefinder mode with a long press of the **M (13)** button.

## 7. Accessory Equipment: Remote control/ App software



Fig. 7-1 Remote control



Fig. 7-2 App

Clip C Series is equipped with external devices that can be connected via bluetooth. The key layout of bluetooth remote control and mobile phone APP is consistent with the key on the Clip C device, including power key, menu key and correction key. The functions and operation methods are also corresponding with Clip C device. (Refer to figure 7-1 and 7-2 for details)

### 7.1 Bluetooth Remote Control

- Turn on the Bluetooth of the device and the icon will show at the bottom of the screen. (refer item 6.5 for details)
- Long pressing the Power button on the remote control for 15 to 30s until the bluetooth icon on the screen turns to  , which means the connection is done and the remote control is ready to use.
- After connecting to the device, if the signal is disconnected in between, the bluetooth remote control will continue to search for connection within 1 minute.
- Turn off the bluetooth on the device, and the remote control will automatically shut down if no bluetooth signal is found within 1 minute.

## 7.2 APP Software

- Turn on the bluetooth of the device and the icon will show at the bottom of the screen. (refer item 6.5 for details)
- Open the APP software on the mobile phone and connect with the device within 1 minute until the bluetooth icon on the screen turns to  which means the connection is done.
- Click the remote control icon on the APP, and operate the Clip C Series with the mobile phone.

## 8. Preventative Maintenance

### 8.1 Battery Installation

- When the icon  is appeared on the status bar, please replace the new battery to supply;
- It is necessary to power off before replacing the batteries;
- Turn the **battery compartment knob (4)** in a counterclockwise until stop and remove it.
- Install two CR123 batteries correctly according to electrode instructions on the label inside the battery compartment as shown in fig. 8-1.
- Replace the battery cover and press heavily until hear clicking sound and make sure the cover is closed on both sides correctly.

#### Note:

- **This device supports to use disposable batteries only. Risk occurs due to inconsistent quality when using rechargeable batteries.**
- please do not use batteries of different types or batteries with various charge levels.
- After installation, please set the battery type in the advanced menu for the first starting up--choosing 3.7V for rechargeable battery and 3V for ordinary battery (according to the instructions of the section 6.5), otherwise the battery level indication will be inaccurate and may be interrupted during operation.



Fig. 8-1 Schematic diagram of battery installation

## 8.2 Product Cleaning and Maintenance

- It is prohibited to clean the unit with the cleaning product which is corroded or scratched to optical glass.
- The unit can be scrubbed with soft cloth by dipping certain amount of alcohol.
- For optical glass devices such as eyepiece lens and objective lens, dust should be blown first, and then use charcoal pen or fat-free cotton dipping non-methylated alcohol to wipe slightly.

## 8.3 Safety Regulation

- Please use standard batteries. Do not throw the batteries away or put them into fire after usage.
- Please use standard charger to prevent the product from damage.
- Short circuit products are prohibited.
- It is prohibited to expose the product in the high temperature environment more than 60°C.
- It is prohibited to put the product into fire.

## 9. General Trouble Shooting

**Table 9-1** General trouble shooting

<b>Trouble description</b>	<b>Probable reason</b>	<b>Trouble shooting</b>
Image blurring	The focal length of the objective lens does not meet.	Adjust the focal length of objective lens until the image becomes clear.
	No image correction for a long time.	Perform image correction.
Blurred vision	Sight distance inadequacy.	Adjust the sight distance of eyepiece until image becomes clear.
No analog video output	Analog video doesn't open.	Open analog video output.
	Data cable doesn't support data transmission.	Replace data cable.
Fail to start up	Wrong battery installation or low power.	Check the battery installation and battery power.
	Insufficient external supply voltage.	Check the voltage of external power supply.
The attachment's eyepiece is stuck during installation.	Eye relief mounting limit block isn't placed parallel to the guide slot and the position is dislocation.	Loosen the eyepiece, push it back to square, and then rotate the mounting.

★Please contact with us as soon as possible if there are some abnormalities. Private demolition is strictly prohibited.

## 10. Appendix

### 10.1 User Interface Description

- Custom interface and data cable are adopted to support type-c power supply, serial port and PAL video;
- Support type-c and battery power supply, support over-voltage and under-voltage reverse connection protection.

### 10.2 Product Dimensions

#### 10.2.1 Boundary Dimension

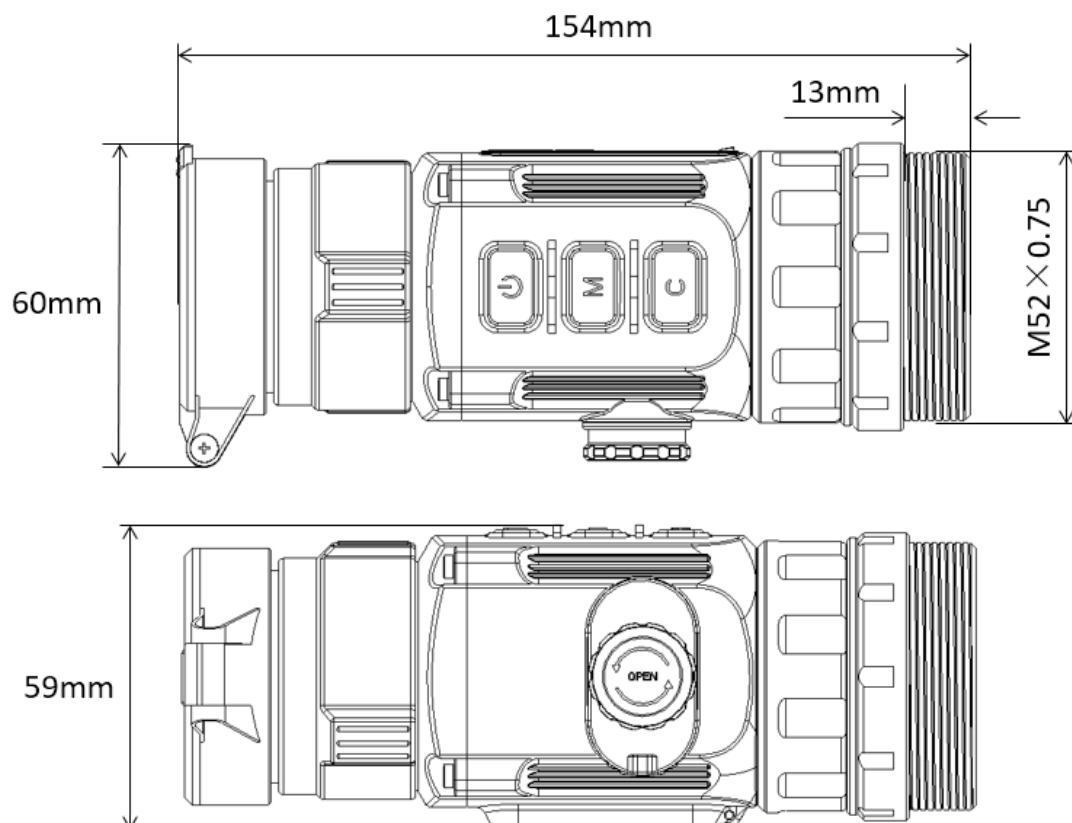

## 10.2.2 Bottom Mounting Hole Size

