



## TW-759-1 **ASW 28**

### Specification

Wing Span:	2540mm ( 63")
Length:	1132mm ( 41.1")
Flying Weight:	1050g
Battery:	11.1V/1500mAh / 20C
Motor:	Brushless 850KV
ESC:	30A Brushless ESC
Radio:	2.4G 6-Channel Proportional Control
Range:	600m

- Your airplane should not be considered a toy, but rather a sophisticated working model that functions very much like a full - size airplane. Because of its performance capabilities, the plane, if not assembled and operated correctly, could possibly cause injury to yourself or spectators and damage property.
- Keep items that could become entangled in the propeller/ rotor blades away from the propeller/rotor, including loose clothing, tool , etc. Be especially sure to keep your hands, face and other parts of your body away from the propeller/rotor blades.
- As the user of this product you are solely and wholly responsible for operating it in a manner that does not endanger yourself and others or result in damage to the product or the property of others.
- You must assemble the model according to the instructions. Do not alter or modify the model, as doing so may result in an unsafe or unflyable model. In a few cases the instructions may differ slightly from the photo. In those instances the written instructions should be considered as correct.
- If you are not an experienced pilot or have not flown this type of model before, we recommend that you get the assistance of an experienced pilot in your R/C club for your first flight. If you are not a member of a club, your local hobby shop has information about clubs in your area whose membership includes experienced pilots.
- While this kit has been flight tested to exceed normal use, if the plane will be used for extremely high stress flying, such as racing , or if an engine larger than one in the recommended range is used, the modeler is responsible for taking steps to reinforce the high stress points and / or substituting hardware more suitable for the increased stress.

**We , as the kit manufacturer, provide you with a top quality, thoroughly tested kit and instructions, but ultimately the quality and flyability of your finished model depends on how you build it; therefore, we cannot in any way guarantee the performance of your completed model, and no representations are expressed or implied as to the performance or safety of your completed model.**

## Kit Contents

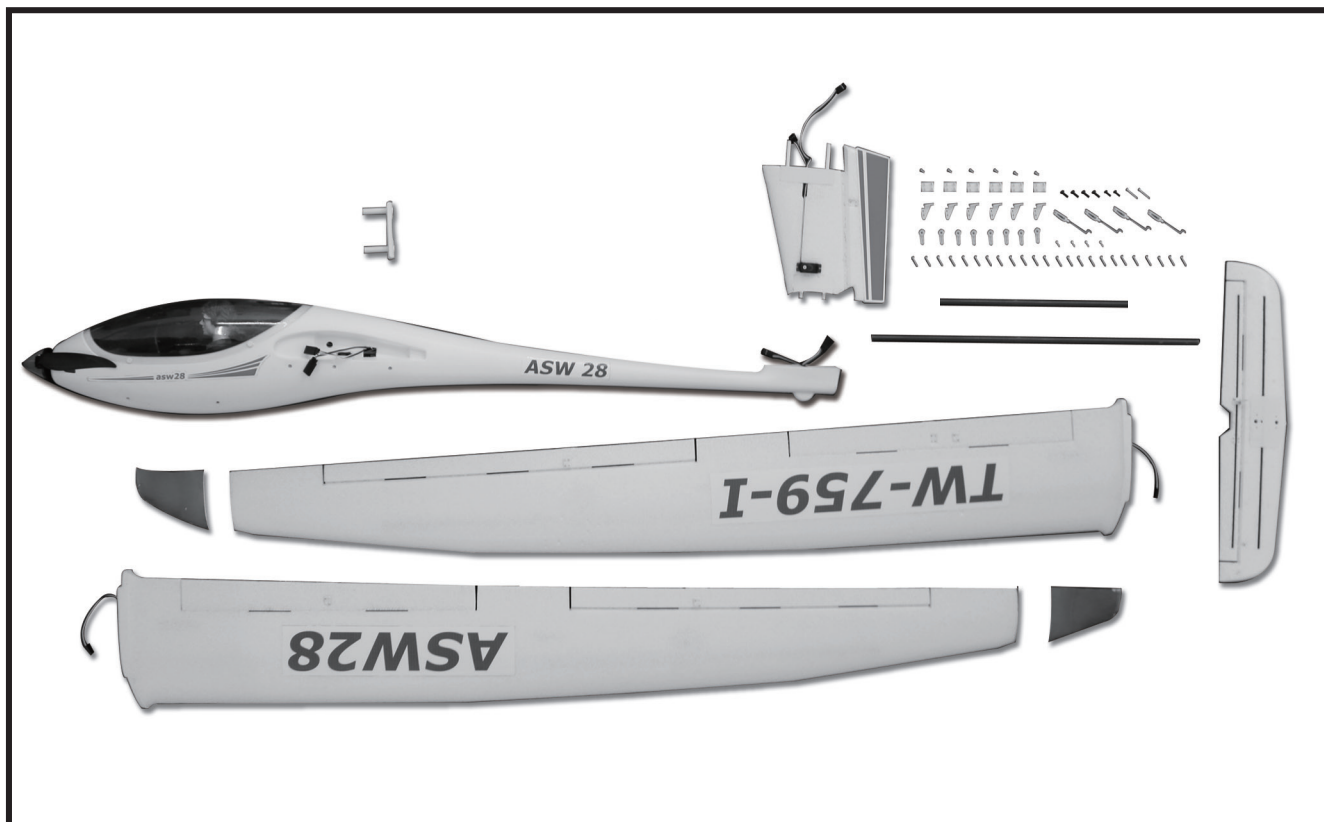

## Assemble The Plane

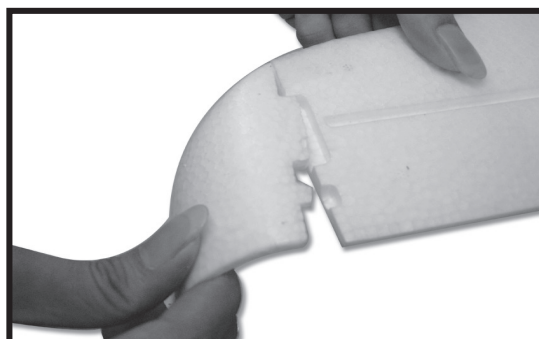
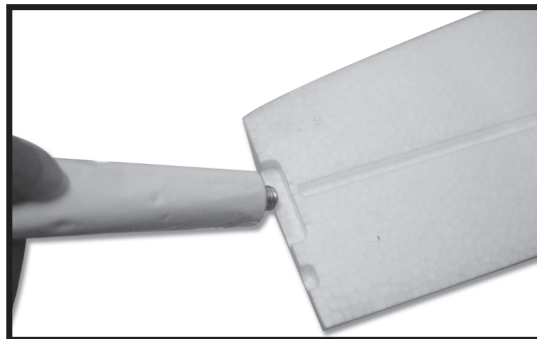
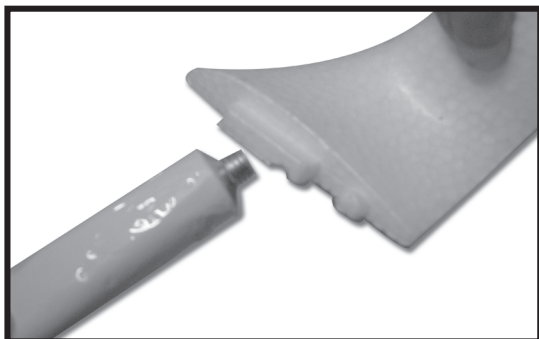

1. Use foam glue(not included) to stick the wingtip to the main wings.

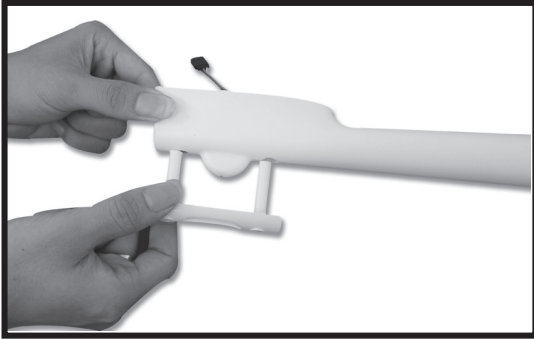

2. Insert the linker to the corresponding hole of the tail.

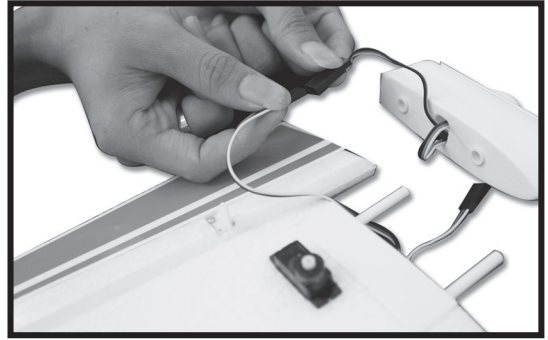

3. Connect the servo wire of the tail.



4. Install the rudder to the fuselage by screw.

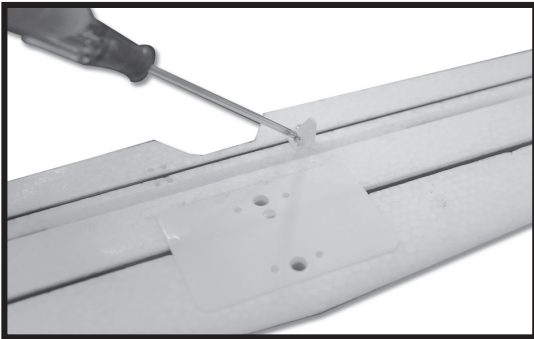

5. Install all the servo horn by screw.

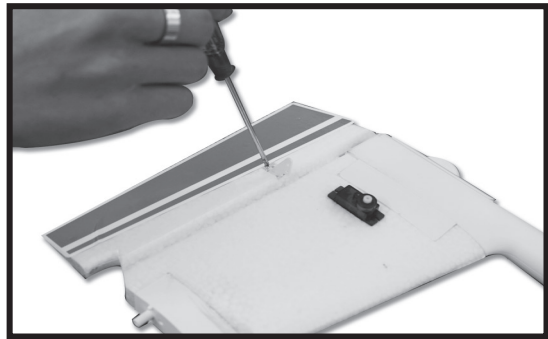

6. Install the elevator to the rudder by screw.

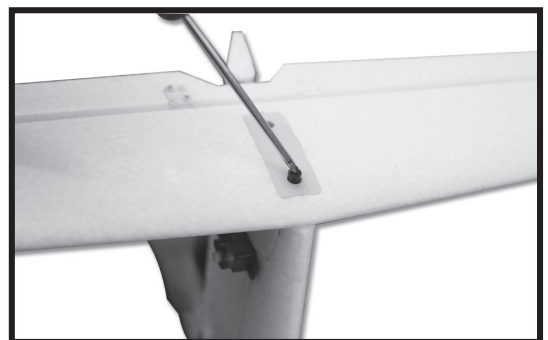



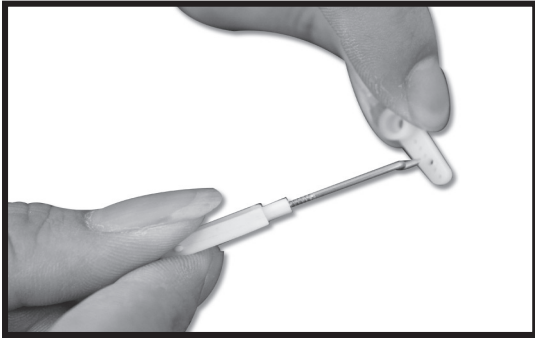

7. Connect the pushrod to the servo arm.

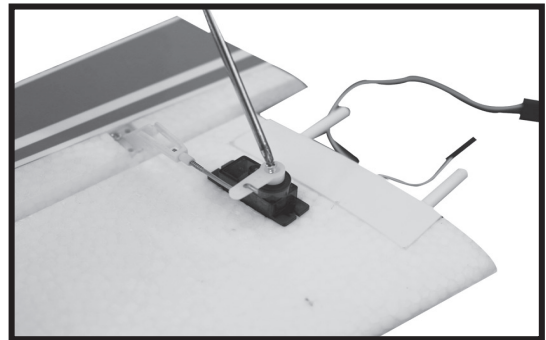
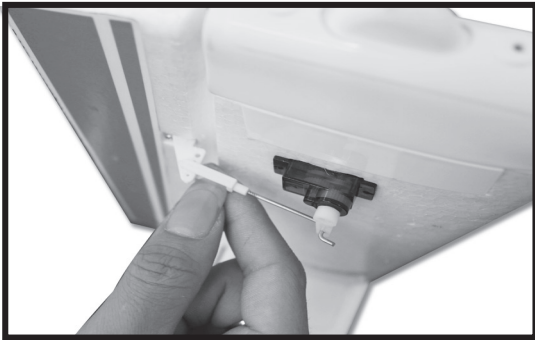

8. Connect the pushrod to the servo horn and fix the servo arm to the servo by screw.

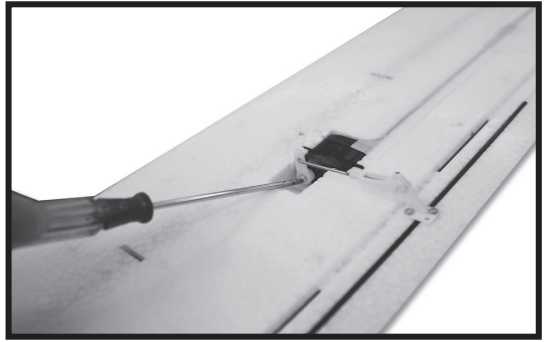
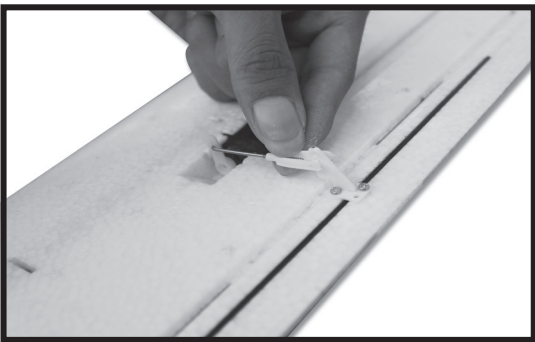

9. Connect the pushrod to the aileron and fix the servo arm by screw.



10. Insert the metal pipes to the main wing.



11. Put the metal pipes through the corresponding hole of the fuselage and connect the servo wires of the ailerons and flaps.



12. Connect the main wings to the fuselage and fix them by plastic clevis. Ensure that a sound of “click” to tighten the main wings to the fuselage.



13. Plug the battery then cover the canopy.

## Centering the Control Surfaces

With the transmitter turned on and the LiPo flight battery connected to the ESC ( and installed in the battery compartment) it's now possible to connect the pushrods to the rudder and elevator control surfaces and to 'center' the surfaces accordingly.

Firstly, be sure to center the elevator and rudder ( aileron ) trim levers. Press the trim button till it has a short and big drop sound, ( a long and big drop sound means you reach the end of the trim in one side).

With the trim levers centered, carefully spread open each 'clevis' ( the white color plastic part installed on the threaded end of the metal pushrod ) so you can insert the pin in the OUTERMOST hole on each control horn. It may be helpful to insert a flat blade screwdriver (not included) into the clevis then carefully 'twist' it until it disengages the pin from the hole in the clevis. Also, it is not necessary to 'snap' the clevis back together until the centering adjustments are complete.



After connecting the clevises to the control horns view the vertical tail and rudder from directly above. The rudder should be 'in line' with the vertical tail when it's properly 'centered'. However, if the rudder is angled off to the right or left you can adjust the length/position of the pushrod/clevis so the surface is centered 'mechanically' while the trim lever on the transmitter is centered.

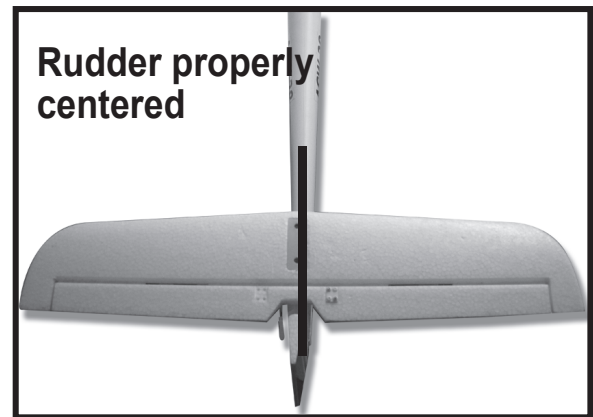
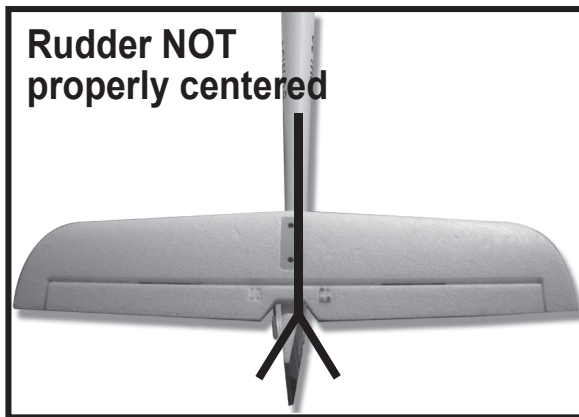

If the rudder is angled off to the left carefully remove the clevis from the control horn and screw it 'in' (clockwise) one half to one full turn then insert the pin back into the outermost hole in the control horn. Or, if the rudder is angled off to the right carefully remove the clevis from the control horn and screw it 'out' (counter-clockwise) one half to one full turn then insert the pin back into the outermost hole in the control horn.

View the vertical tail and rudder from directly above again and continue adjusting the length/position of the pushrod/ clevis until the rudder is centered appropriately.

**NOTE:** You should always rotate the clevis until the pin is perpendicular with the control horn to ensure the pin is not under any excessive load/ pressure when inserted in the hole and during operation. In some cases it may not be possible to 'exactly' center the surface mechanically while properly aligning the pin. In these cases be sure the pin is properly aligned then adjust the position of the trim lever slightly as needed. Also, it will likely be necessary to make

further adjustments to the position of the trim lever during flight as most surfaces do not end up in exactly the centered position when an airplane is trimmed properly for actual flight (but 'centered' is still the best starting point).

Follow the same steps outlined for centering the rudder to center the elevator (and aileron) as well.

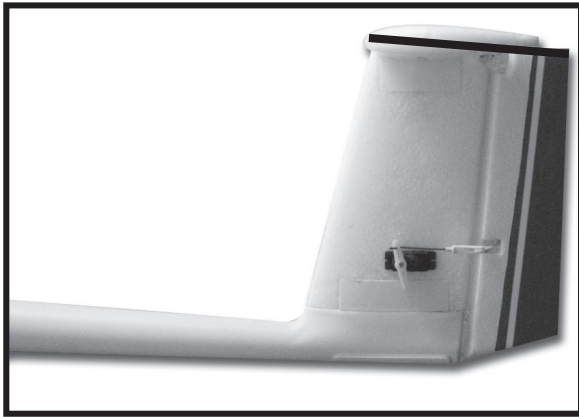

Also, we strongly recommend installing the included 'clevis keepers' to provide added security for the clevises. Typically you can carefully slide the keepers over the clevises when they are not connected to the control horn. Then, after connecting the clevis to the control horn and 'snapping' the clevis together you can slide the keepers into a position that does not allow them to 'bind' against the control horn during movement of the surface.

## Center of Gravity

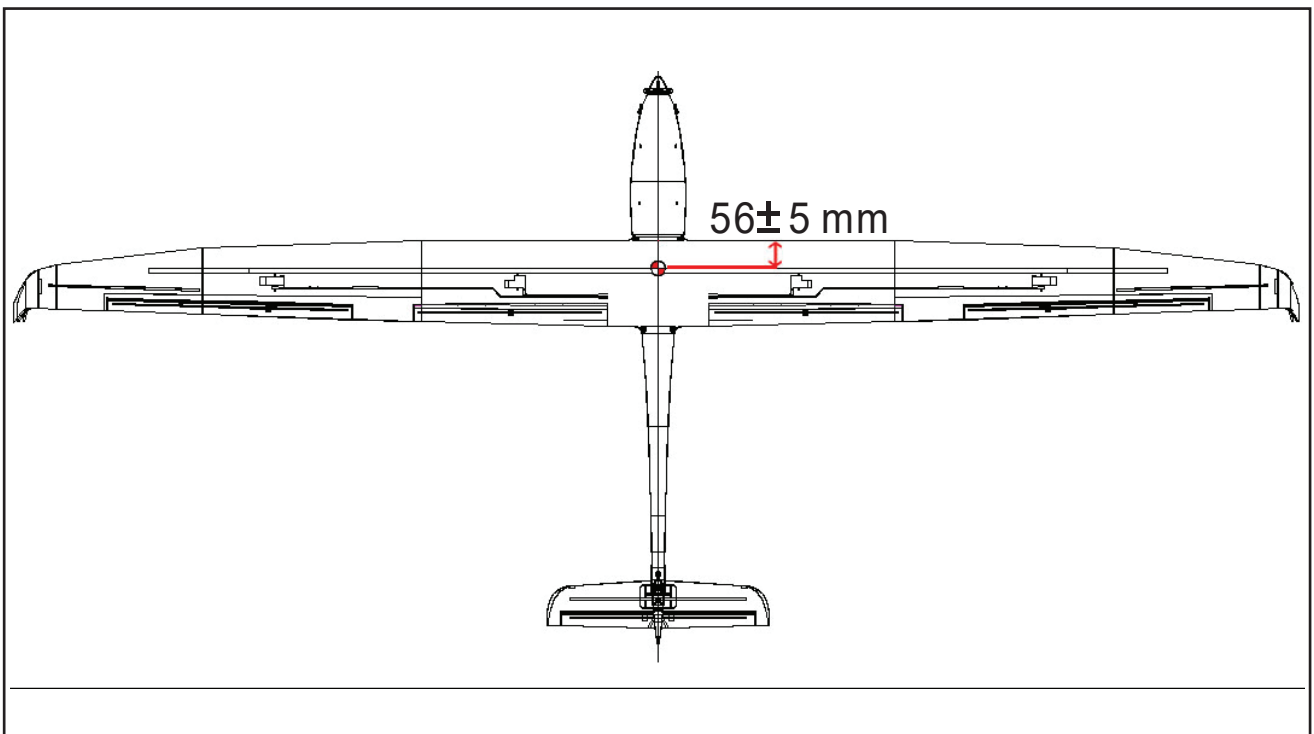

The ideal C.G. position is  $56 \pm 5$  mm behind the leading edge measured at where the wing meets the fuselage. The C.G. has a GREAT effect on the way of the model flight. If the C.G. is too far aft (tail heavy), the model will be too responsive and difficult to control. If the C.G. is too far forward (nose-heavy), the model will be too stable and not responsive enough. In order to obtain the C.G. specified, add weight to the fuselage or move the battery position. Check the C.G. before flying.

## Battery Warnings

**IMPORTANT NOTE:** Lithium Polymer (LiPo) batteries are significantly more volatile than the alkaline, NiCd and NiMH batteries also used in RC applications. All instructions and warnings must be followed exactly to prevent property damage and/or personal injury as mishandling of LiPo batteries can result in fire.

By handling, charging or using the included LiPo battery you assume all risks associated with LiPo batteries. If you do not agree with these conditions, please return your complete product in new, unused condition to the place of purchase immediately.

You must read the following safety instructions and warnings before handling, charging or using the LiPo battery.

- You must charge the LiPo battery in a safe area away from flammable materials.
- Never charge the LiPo battery unattended at any time. When charging the battery you should always remain in constant observation to monitor the charging process and react immediately to any potential problems that may occur.
- After flying / discharging the battery you must allow it to cool to ambient / room temperature before recharging. Also, it is NOT necessary or recommended to discharge the battery 'completely' before charging (LiPo batteries have no 'memory' and it's safe to charge partially discharged batteries when using an appropriate charger and settings).

- To charge the battery you must use only the stock included Charger or a suitably compatible LiPo battery charger. Failure to do so may result in a fire causing property damage and/ or personal injury. DO NOT use a NiCd or NiMH charger to charge Li-Po battery.
- If at any time during the charge or discharge process the battery begins to balloon or swell, discontinue charging or discharging immediately. Quickly and safely disconnect the battery then place it in a safe, open area away from flammable materials to observe it for at least 15 minutes. Continuing to charge or discharge a battery that has begun to balloon or swell can result in a fire. A battery that has ballooned or swollen even a small amount must be removed from service completely.
- Store the battery partially charged (approximately 50% charged/3.85V per cell), at room temperature (approximately 68–77° Fahrenheit [F] ) and in a dry area for best results.
- When transporting or temporarily storing the battery, the temperature range should be from approximately 40–100°F. Do not store the battery or model in a hot storage car or direct sunlight whenever possible. If stored in a hot garage or car the battery can be damaged or even catch fire.
- Do not over-discharge the LiPo flight battery. Discharging the LiPo flight battery to a voltage that is too low can cause damage to the battery resulting in reduced power, flight duration or failure of the battery entirely.
- LiPo cells should not be discharged to below 3.0V each under load. In the case of the 2-Cell/ 2S 7.4V LiPo battery used to power the plane you will not want to allow the battery to fall below 6.0V during flight.

The included ESC features a 'soft' low voltage cutoff ( LVC ) that smoothly reduces power to the motor (regardless of the power level you have set with the throttle stick) to let you know the voltage of the battery is close to the 6.0V minimum.



## Know Your Frequency

Based on the size and weight of the plane it's typically considered to be a 'park flyer' class model. As a result it's best to fly the plane at a local park, schoolyard, flying field or other area that's large enough and free of people and obstructions. We recommend an area the size of at least one football/ soccer field, however, even larger areas are better suited and preferred especially when learning how to fly. **DO NOT fly in parking lots, crowded neighborhood areas or in areas that are not free of people and obstructions.**

We also suggest flying over grass as it's a much more forgiving surface that causes less damage in the unfortunate event of a crash. Short grass is better for takeoffs and landings as grass that is too long can cause the airplane to nose-over /flip and be damaged. An ideal flying area allows for takeoffs and landings on a smoother surface (such as asphalt) and flying over grass.

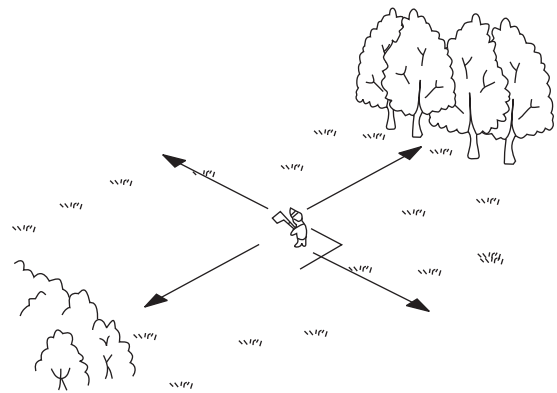

Fly in spacious ground without obstacles and boscage.

**PLEASE NOTE: The plane is designed to be flown outdoors only.**

### Flying Conditions

It's typically best to fly on days that are calm with no wind, especially when learning how to fly. We strongly suggest flying only in calm conditions until you're familiar with the controls and handling of the model. Even light winds can make it much more difficult to learn to fly, and in some cases can even carry the model beyond your line of sight.

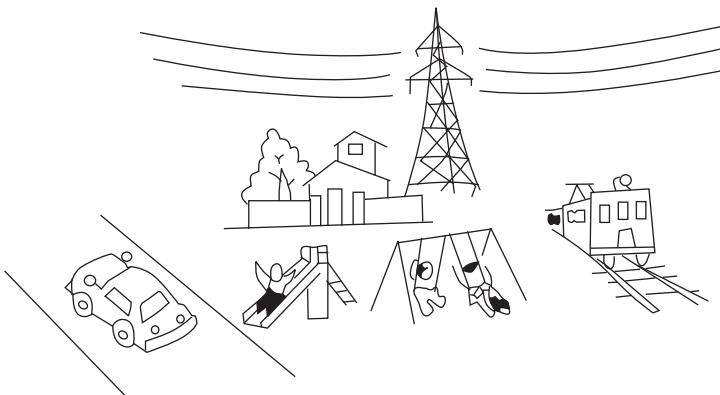

Never fly the plane near Highway, railway, high tension line, crowd people, Flying Area, and residential area.

**Also, if you are a first-time or low - time pilot we highly recommend allowing a more experienced pilot to test fly and properly trim the model before attempting your first flight. A proven flyable and properly trimmed model is significantly easier and more enjoyable to fly! Please contact your local hobby shop and/or flying club to find a more experienced pilot near you.**

After you've properly trimmed the airplane in calm conditions and become familiar with its handling /capabilities you'll be able to fly in light winds, or depending on your experience and comfort level, in winds up to 5–7 mph.

**DO NOT fly on days when significant moisture, such as rain or snow, is present.**

**VOLANTEX** RC  
PRODUCED, DESIGNED  
AND BACKED BY **EX-HOBBY**