

Technical Specifications

Model BP-JB-BOX

General

Material Aluminum

Dimension $\phi 149\text{mm} \times 140,5\text{mm}$ ($\phi 5,87'' \times 5,53''$)

Weight 3kg (6,6lb)

Color White

Operation temperature $-40^{\circ} \sim +60^{\circ}$ ($-40^{\circ} \sim +140^{\circ}$)

Humidity 0~90% RH

Compatibility

Hinged Junction Box for BN8035/NDAA, BN8036AI/NDAA, BN9036AI/NDAA, BN8037AI/NDAA

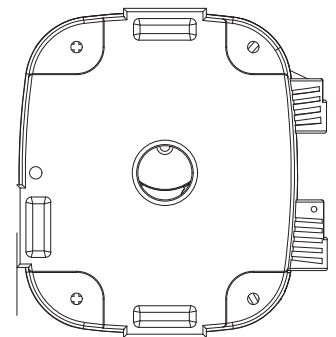
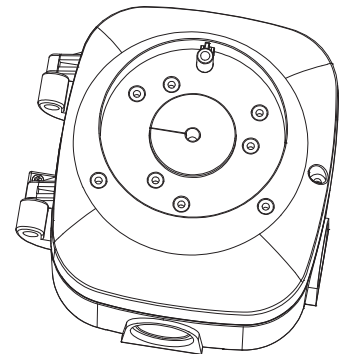
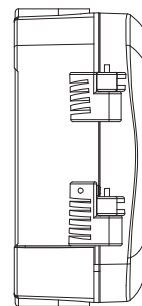
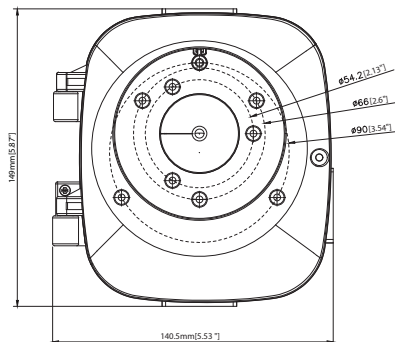
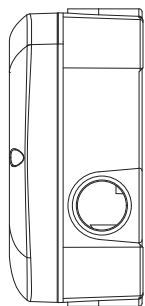
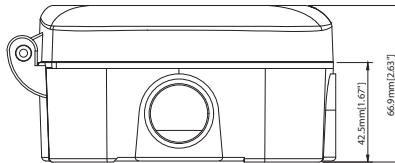
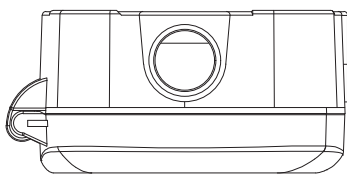
Dimensions

* Specifications Are Subject to Change Without Notice.