



CONNECT AND PROTECT

Lightning Protection Solutions

nVent ERICO System 2000



nvent

ERICO

nVent Engineered Electrical & Fastening Solutions is a leading global manufacturer and marketer of superior engineered products for niche electrical, mechanical and concrete applications. These nVent products are sold globally under a variety of market-leading brands: nVent ERICO welded electrical connections, facility electrical protection, and rail and industrial products; nVent CADDY fixing, fastening and support products; nVent ERIFLEX low voltage power and grounding connections; and nVent LENTON engineered systems for concrete reinforcement.

For more information please visit nVent.com/ERICO.

CHAPTER CONTENTS

INTRODUCTION	4
THE NEED FOR LIGHTNING PROTECTION	5-8
ISOMETRIC VIEW OF CABLE LIGHTNING PROTECTION LAYOUT	9
TYPICAL INSTALLATION DRAWINGS	10-12
CONDUCTORS	13-16
AIR TERMINALS & ADAPTORS	17-20
POINT BASES, BRACES & ACCESSORIES	21-26
INDUSTRIAL STACK EQUIPMENT	27-32
CONDUCTORS, CLAMPS, PLATES & LUGS	33-38
THROUGH ROOF, THROUGH WALL & CABLE PROTECTORS	39-42
GROUNDING ACCESSORIES	43-48
NVENT ERICO CADWELD LIGHTNING PROTECTION MOLDS	49-52
CABLE FASTENERS & ACCESSORIES	53-56
INDEX	57-60

nVent designs and manufactures products to comply with various national and international standards. The lightning protection components in this catalog have been designed to comply with UL®96 unless otherwise noted. Due to the fact that standards are continually changing, please refer to our website for the latest compliance information.



FACILITY ELECTRICAL PROTECTION PRODUCTS

Lightning protection, grounding, equipotential bonding and surge protection are all interdependent disciplines and the focus of the nVent ERICO brand of facility electrical protection products. Reliable protection of structures, industrial and commercial operations and personnel demands a systematic and comprehensive approach to minimizing threats caused by transients. For instance, no air terminal can safely capture and arrest the lightning energy without a dependable route to ground. Equally, even the most expensive Surge Protection Device (SPD) will not provide optimum protection if a low-impedance electrical connection to the ground is not present. Additionally, a low-impedance ground system may create hazards to equipment and personnel alike if equipotential bonding practices are not followed. These interdependent disciplines are best applied when looking at a total facility rather than an individual piece of equipment or a portion of the facility. The nVent team of qualified applications engineers is here to help with such problems.

Since no single technology can eliminate the harmful effects of lightning or induced-surge transients, nVent has developed the Six Point Plan of Protection. The concept behind this plan is to prompt the user to consider a holistic and coordinated approach to lightning protection that embraces all aspects of potential damage. This ranges from the more obvious direct strike to the more subtle mechanisms of differential earth potential rises and voltage reduction at service entry points.

The Six Interdependent Disciplines that form the Protection Plan are:

1. Capture the lightning strike
2. Convey this energy to ground
3. Dissipate the energy into the grounding system
4. Bond all ground points together
5. Protect incoming AC power feeders
6. Protect low-voltage data/telecommunications circuits

nVent ERICO System 2000 Lightning Protection Products

This catalog details the System 2000 lightning protection products to meet the needs of points 1 and 2 of the Six Point Plan. For more information on the range of products designed to cover points 3 through 6, please request a copy of the nVent ERICO Grounding, nVent ERICO Cadweld Electrical Connections or the Surge Protection Products catalogs. A portion of nVent's offering for points 3 and 4 is presented.

At nVent, we offer innovative and efficient products along with engineering expertise and top-quality technical support. nVent's quality-assurance program helps ensure that required procedures for every step of the operation produce the best possible system for our clients. nVent also maintains a comprehensive global knowledge pool to meet the challenging requirements of ever-evolving regional and industry applications.

The Need for Lightning Protection

There is no known method of preventing the occurrence of a lightning discharge. The purpose of a lightning protection system, therefore, is to control the passage of a discharge in such a manner that prevents personal injury or property damage.

The need to provide protection should be assessed in the early stages of the structure design. Although no strict rules can be given, it is possible to use broad guidelines to arrive at the degree of protection required.

Critical Factors to be Considered:

1. What is the risk to personnel?
2. What is the risk of equipment or structural damage?
3. What are the consequential problems of such failure?
4. Is the equipment associated with an essential/public service?
5. Is there likely to be substantial revenue loss in the time taken to restore services?
6. Is the structure of historical importance?
7. What are the legal implications of providing inadequate protection?
8. Can the passage of a discharge in a structure or a building give rise to side flashing or simple sparks in an explosive or flammable environment? i.e: The extraction and storage of gas or oil, storage and manufacture of explosives, etc.
9. Can side flashing between metallic structures (as in a ship) cause damage to essential electronics?
10. Will the discharge give rise to corona phenomena causing disastrous surges on the phase wires of electric lines or breakdown in transformer stations?

The assessment of these factors is one of judgement in comparing risks, economics and aesthetics. Such assessment is not always simple.

Lightning is an Unpredictable Phenomenon

It is possible to estimate the number of ground strikes expected per square kilometer per year and statistically determine the risk of a building being struck. While still useful in modern lightning protection techniques, such statistical calculations should, however, be viewed with caution. As an example, it can be shown that a building in a low intensity area should be struck only once in 20 years. However, it is possible to receive several strikes in one storm and then no more for 30 years.

The random nature of lightning means the role of statistics is quite important in determining the need for protection. The answers, however, to the previous 10 questions are equally important in the assessment of the need for lightning protection.



Particularly at Risk:

Installations where lightning protection is highly desirable are summarized as follows:

- Power stations
- Sub-stations and transformer stations
- Oil and gas storage and refinery
- Drilling rigs
- Grain storage
- Explosives factories and storage areas
- Flammable liquid or chemical storage
- Factories such as chemical, textile, rubber, sugar, glass, paint, etc.
- Mining areas
- Television, radio and telecommunications stations
- High rise buildings - commercial and apartment complexes
- Hospitals
- Transport - airports, shipping, rail etc.
- Universities, education facilities
- Historic structures
- Churches, Mosques, etc.
- Military installations
- Golf courses, race courses, sports stadiums, etc.
- Farms and food storage areas
- Buildings containing computers and electronics

In a world of increasingly complex and sophisticated buildings and equipment, lightning is a constant risk. A single direct strike can result in physical damage to buildings and catastrophic failure of sensitive electronic equipment. It can start fires, cause major breakdowns to electrical, telephone and computer installations, and simultaneously cause substantial loss of revenue.

The Need for Lightning Protection

Storm Development and Natural Ionization

A thunderstorm commences with the development of a cumulonimbus thunder cloud. The cloud is typically formed by rapidly rising humid air which becomes electrified due to convection and precipitation effects. This is accompanied by wind speeds of up to 125 miles/hr.

The end result is the separation of positive and negative charges (see Figure 1). In most cases, the lower part of the thundercloud is comprised of a thin, concentrated layer of negative charge, and the upper part comprises a more diffuse positively charged region. The cloud base is typically 1 to 4 miles above the ground and the cloud depth is typically 4 to 8 miles.

As a result of the cloud electrification, a quasi-static electric field is established between the cloud and ground. Pointed ground objects subjected to this **ambient electric field emit varying amounts of point discharge or "corona"**, and the **resulting positive or negative ions drift upwards to form a low density "space charge" which extends from ground to cloud.** This space charge reduces the electric field observed at ground level, typically from 50 - 60 kV/m at heights of 1640 ft. to 2-15 kV/m at the ground.

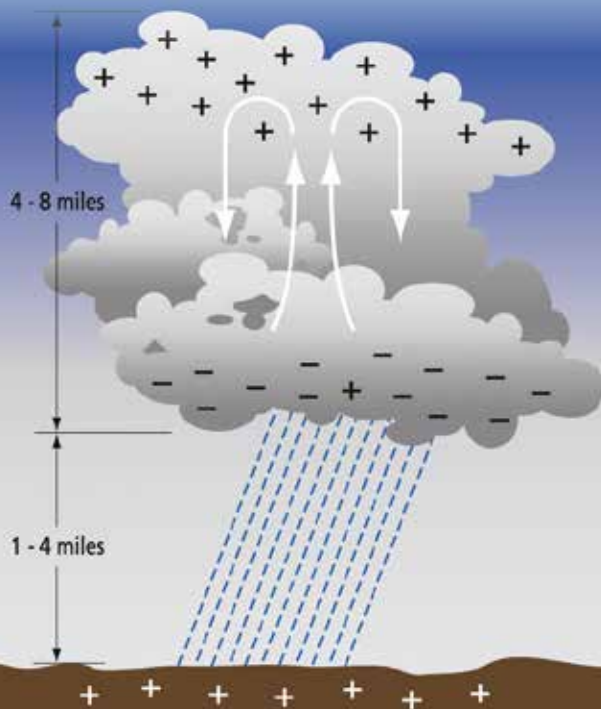

Figure 1. Typical positive and negative charge distribution in the cumulonimbus cloud.

The Lightning Discharge

Within the confines of the cloud, static electricity builds to an extent where one or more neutralizing discharges or flashes occur. These flashes can be in the form of an inter-cloud (cloud-to-cloud), intra-cloud (within cloud) or cloud-to-ground flash.

The dramatic cloud-to-ground flash is of most concern. This dynamic phase of lightning commences in the form of a luminescent downward leader from the base of the cloud, which proceeds in a series of steps and branches toward the ground. The protrusion of ground objects into an ambient electric field (such as that created by a lightning downward leader) increases the electric field at the tip of the object, as shown in Figures 2 and 3.



Figure 2. Field intensification, portrayed with lines of equal voltage (equipotential lines), is a function of the height of the object as well as its degree of "sharpness".

As the downleader approaches, it causes the electric field around points on the surface of the earth to increase rapidly, leading to the initiation of small upward streamers from the elevated points. Under the right conditions, these upward streamers thermalize and become competing upward leaders which propagate toward the approaching downleader, as shown in Figure 4.

The ability of one ground point to develop an upward intercepting leader before other nearby competing points means that it can become the preferred strike point to successfully complete an ionized path between cloud and ground, as shown in Figure 5.

The diagrams on the next page illustrate the varying degrees of electric field intensification created by grounded objects subjected to an ambient electric field (in this case, that of the lightning downward leader).

The Need for Lightning Protection

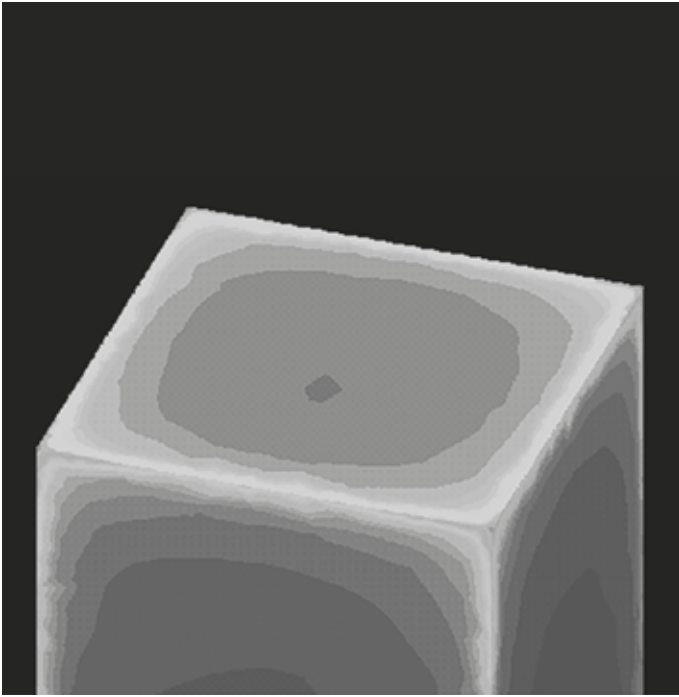

Figure 3. Electric field plot of a real structure in an ambient field, showing that the intensification is high at the corners, moderate on the horizontal and upper vertical edges and very low on flat horizontal and vertical surfaces.



Figure 5. Upward leaders propagate toward downward leader to complete the ionized path between cloud and ground.

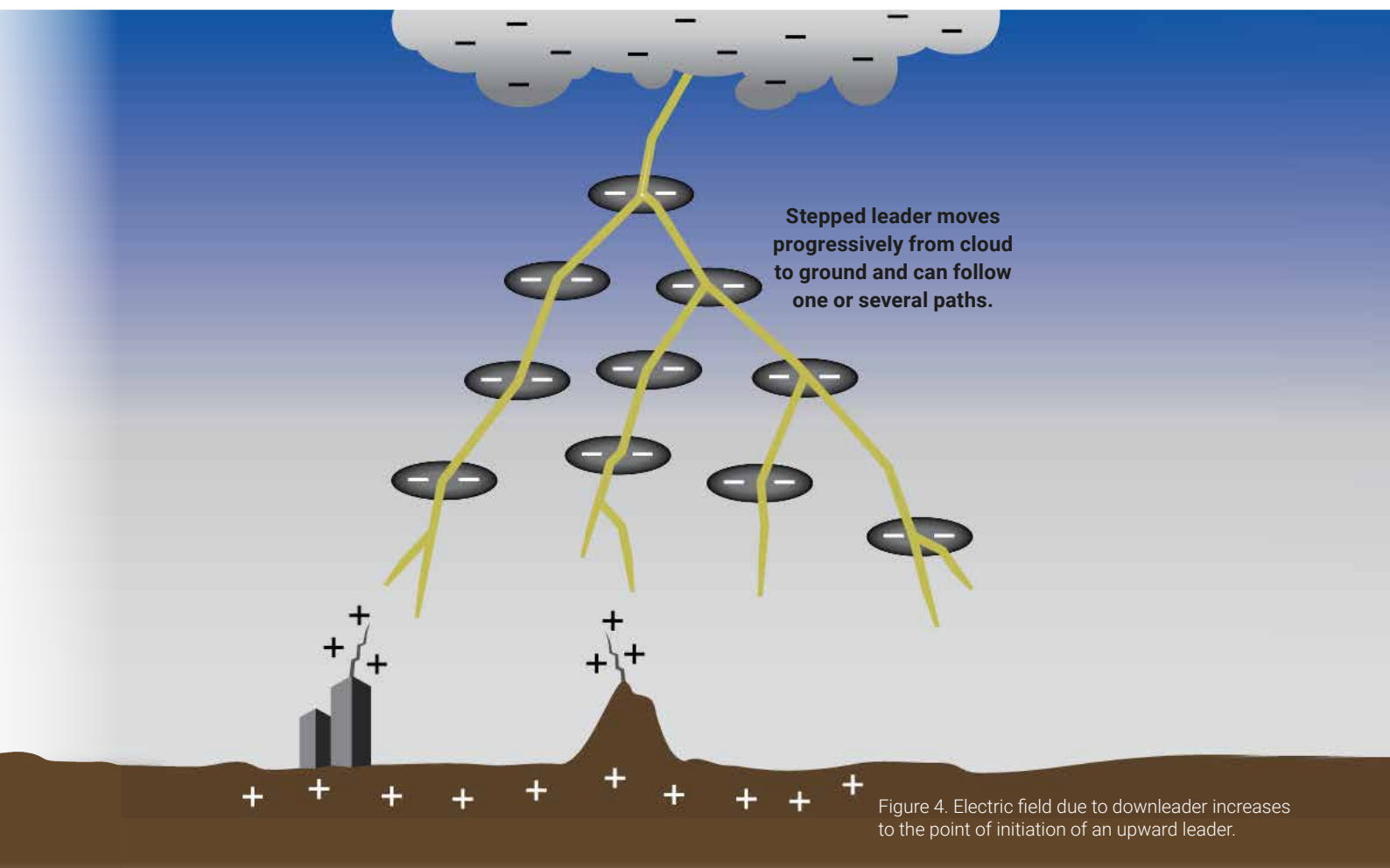

Figure 4. Electric field due to downleader increases to the point of initiation of an upward leader.

The Need for Lightning Protection

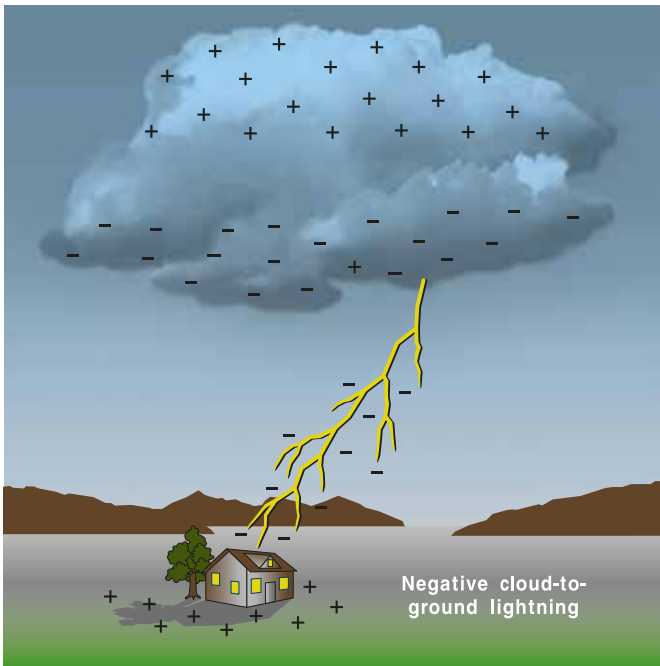

Figure 6. Negative cloud-to-ground lightning.

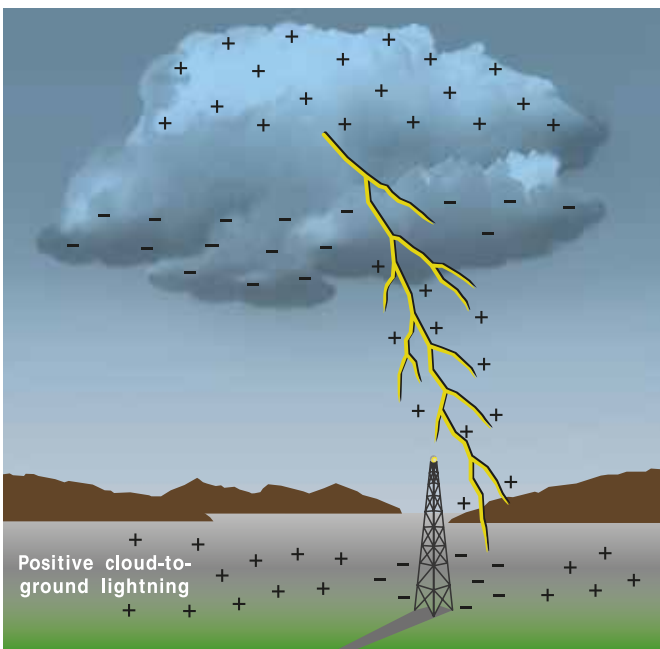

Figure 7. Positive cloud-to-ground lightning. Negative and positive cloud-to-ground lightning typically occurs to an approximate ratio of 90:10.

Typically, 90% of cloud-to-ground flashes transfer negative charge (negative lightning), as shown in Figure 6. Such a flash consists of a sequence of one or more high amplitude, short duration current impulses or strokes. The subsequent strokes are sometimes called restrikes.

A small proportion of flashes transfer positive charge to ground (positive lightning), as shown in Figure 7. Typically 10% of lightning flashes are positive, although this can vary with latitude and season. The parameters for positive lightning differ considerably from their negative counterparts. Some of the main differences are that the:

- restrike phenomenon is absent (no subsequent strokes)
- peak current is higher (~ 2 x)
- maximum rate of rise of current is less (~ 0.1 x)
- total rise time is longer (~ 4 x)
- stroke duration is longer (~ 4 x)
- action integral (energy content) is higher (~ 10 x)

In summary, the main lightning discharge is characterized by a rapidly rising current (averaging about 30,000 Amps) with maximum values exceeding 200,000 Amps. This whole process is extremely rapid, typically occurring within milliseconds. The average energy released in a single discharge may be 55 kW hours. The danger lies in the extremely high rate of current rise (up to 10^{10} Amps per second) which can generate very high voltages, and also from the continuing current following the peak.

Without proper intervention to capture and control the passage of this lightning energy to ground, cloud-to-ground lightning can be catastrophic.

Capturing the Lightning Discharge

In general, the highest point of a facility is the most vulnerable to a direct lightning strike. Lightning rods or air terminals are needed to capture the strike to a preferred point, and to help conduct the energy to ground to minimize the risk of damage. The number of terminals required, and their placement, is determined by the chosen lightning protection design method.

The placement of air terminals is a critical part of the lightning protection design process. Since the 1750's the most popular methods of lightning protection have involved sharp vertical rods (Franklin), horizontal and vertical conductors (Faraday Cage or Mesh) or a combination of both. Only if air terminals are placed in the optimum location on the structure is it possible to achieve an efficient and reliable lightning protection system. Historically, a number of methods have been employed, some of which are still in common use, such as the Cone of Protection (Protective Angle), Mesh and Rolling Sphere methods.

Isometric View of Cable Lightning Protection Layout

Legend

•	Air Terminal Location		No. LPC126 Copper Ground Loop Conductor (Min. Class II Cable)
□	Through Roof Connection Location		No. LPA141 Aluminum Secondary Bonding (#4 AWG)
€	Through Wall Connection Location		Exhaust Fan
⊥	Ground Rod Location		Misc. Mechanical Equipment
⊥	Through Roof Cable to Steel Connection		Vent Through Roof
— — — — —	No. LPC120 Copper Cable (#2 AWG)		Roof Drain
- · - · - · - · - · -	No. LPC126 Copper Cable (Min. Class II Cable)		A.F.G.
⏟⏟⏟⏟⏟⏟⏟⏟⏟⏟	No. LPC151 Copper Secondary Bonding Wire (#6 AWG)		Above Finished Grade

Note: The lightning protection materials to be used for this type of installation may be aluminum or copper, within the allowances of NFPA® code 780. Some of the criteria for choosing one type of material over another are as follows:

1. Matching of materials to which lightning protection components are to be installed for compatibility; aluminum on aluminum, copper on copper, etc.
2. Location of materials (i.e. within concrete, below grade, etc.)
3. Lightning protection components to match existing lightning protection materials.
4. Personal preferences of owner, architect, engineer, etc.

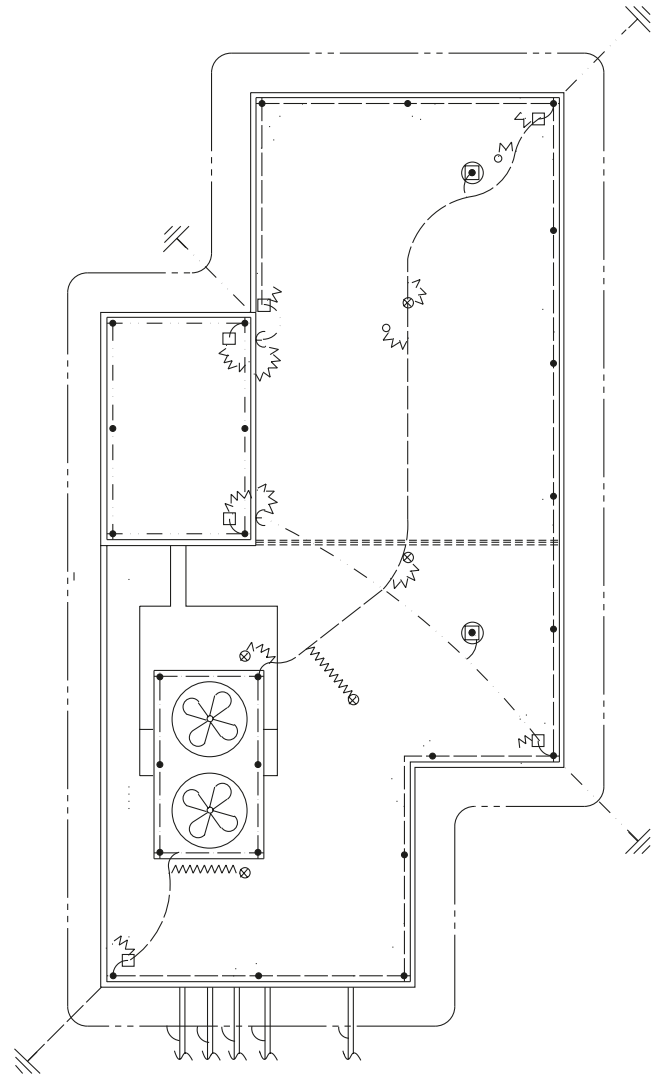
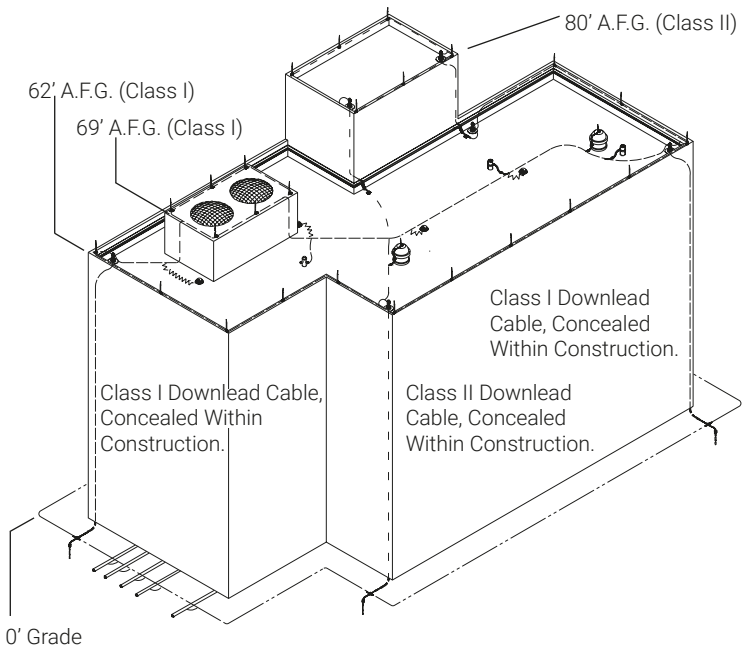

Typical Installation Drawings

Typical Parapet Air Terminal

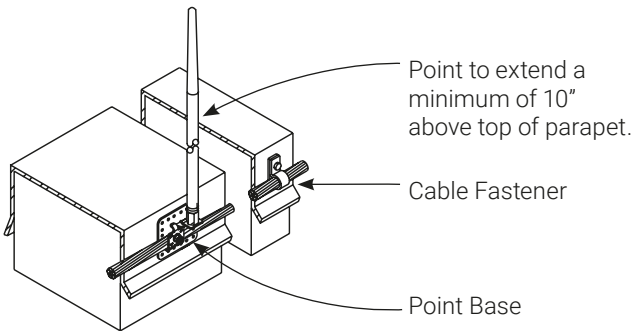

Typical Mid-Roof Air Terminal

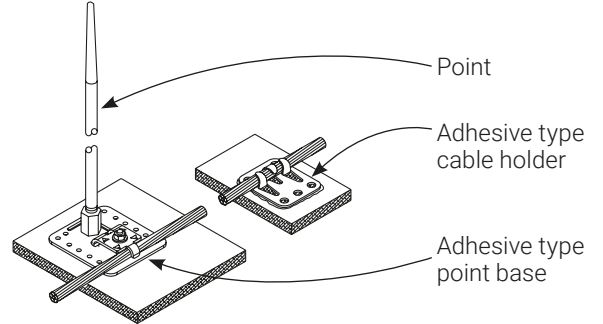

Typical Top Mount Air Terminal

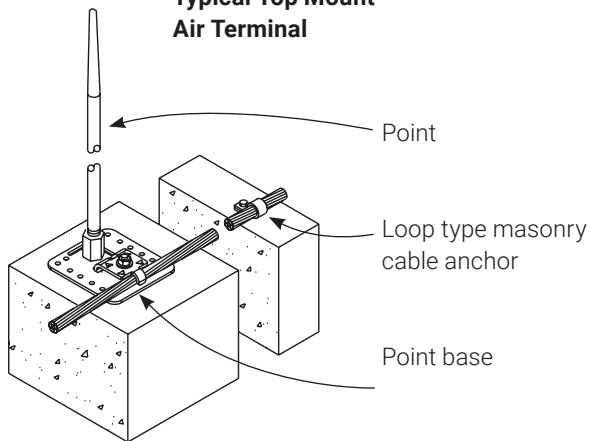

Typical Air Terminal Placement at Outside Corners

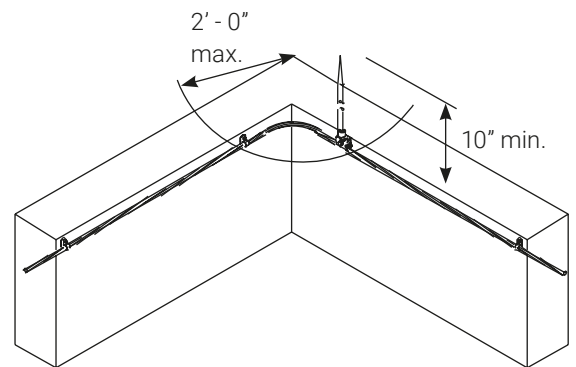

Typical Tri-Pod Mid-Roof Air Terminal

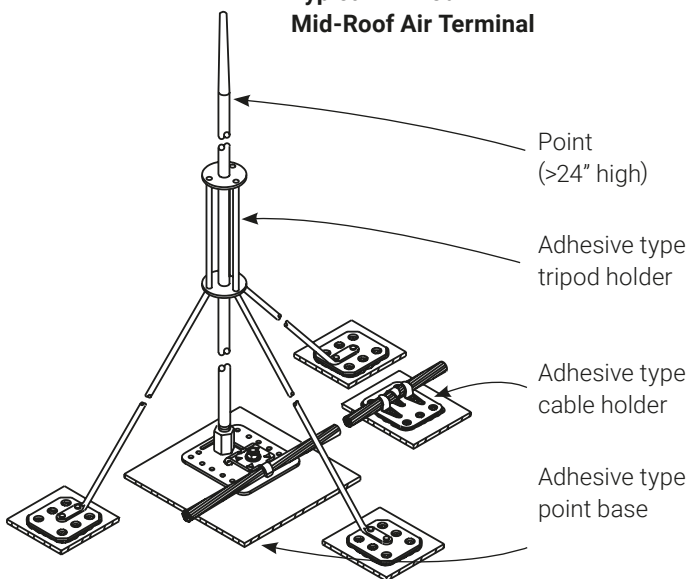

Typical Concealed Downlead to Lower Roof

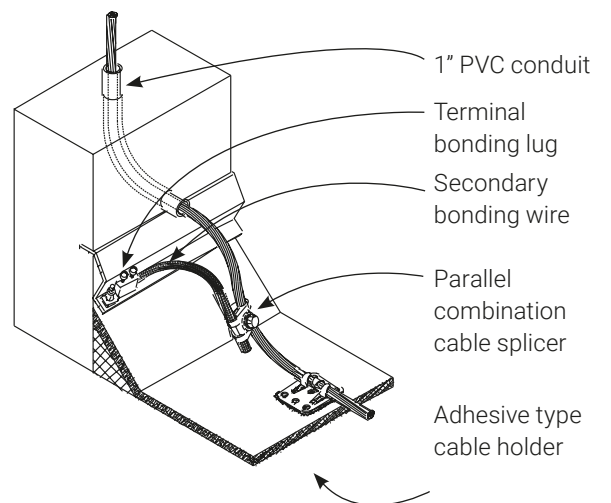

Typical Installation Drawings

Typical Through Roof Connection

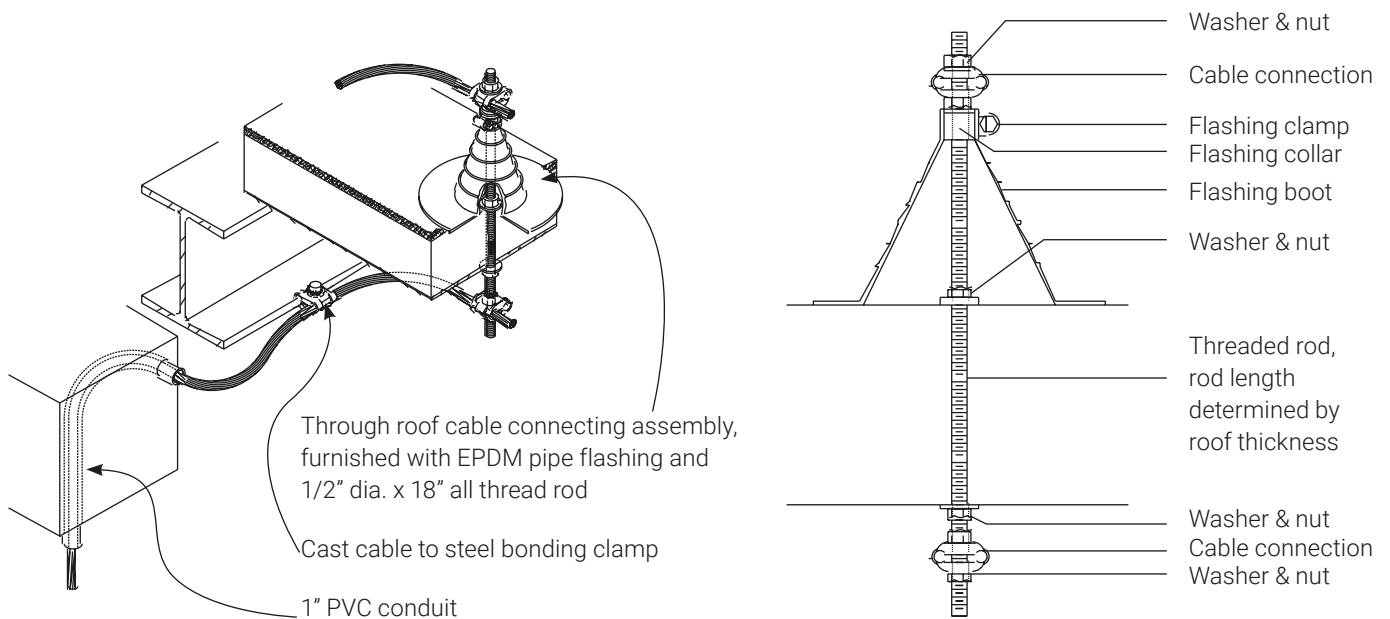

Typical Steel Column Grounding Connection

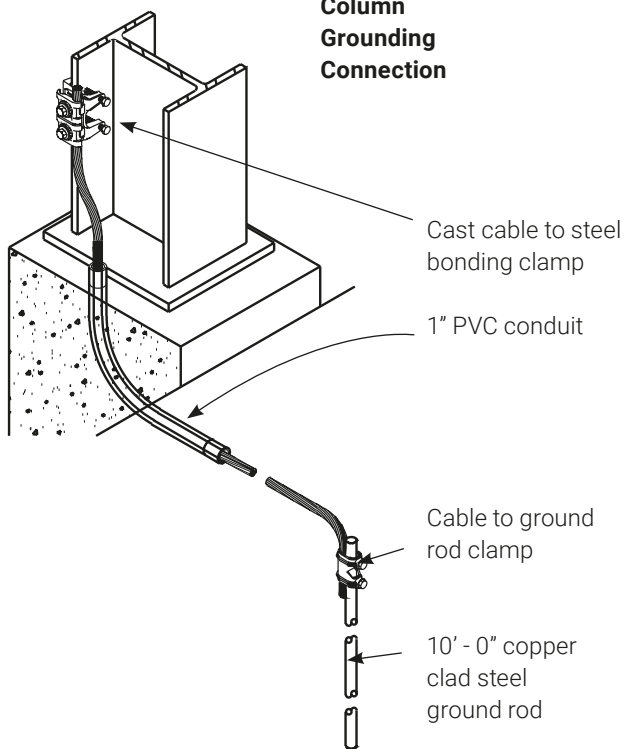

Typical Concealed Download to Grounding Connection

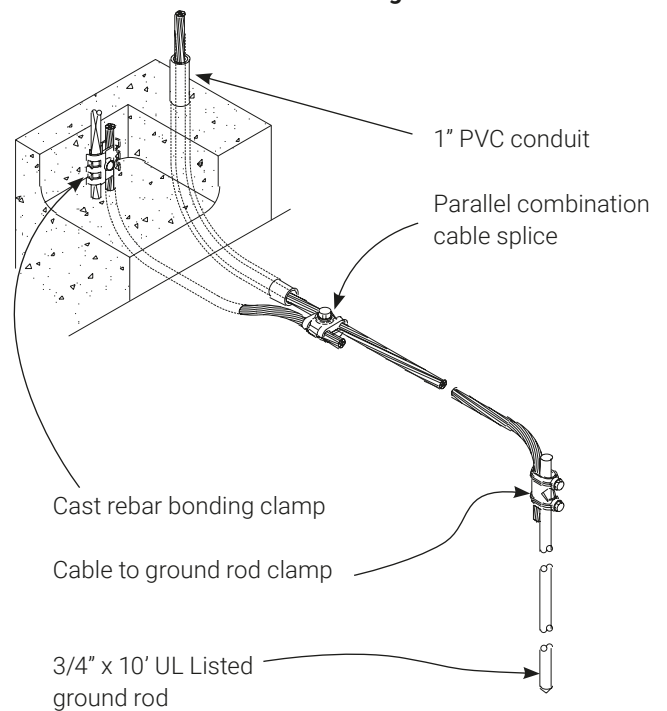

Typical Installation Drawings

**Typical Exposed
Downlead to
Lower Roof at
Screenwall**

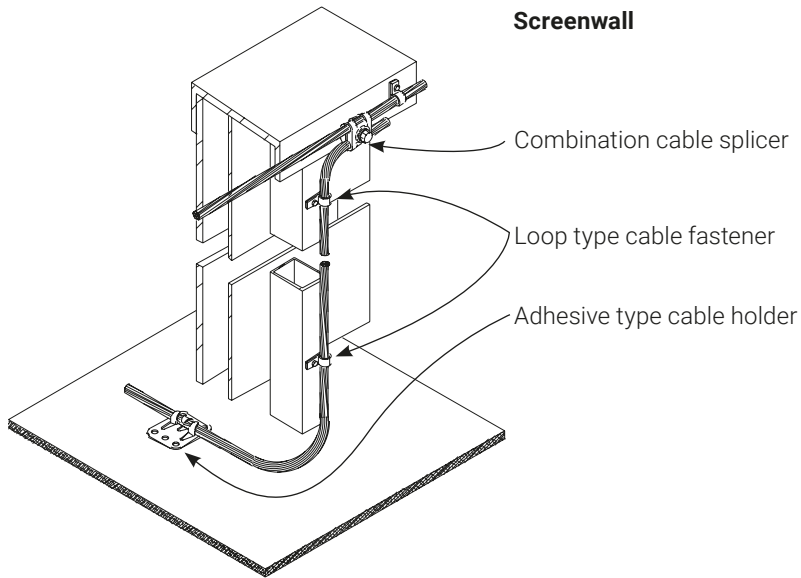

**Typical
Flashing
Bond**

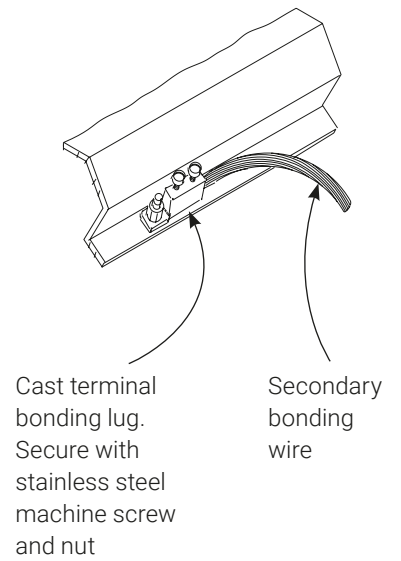

**Typical Metallic
Water Pipe
Bonding Clamp**

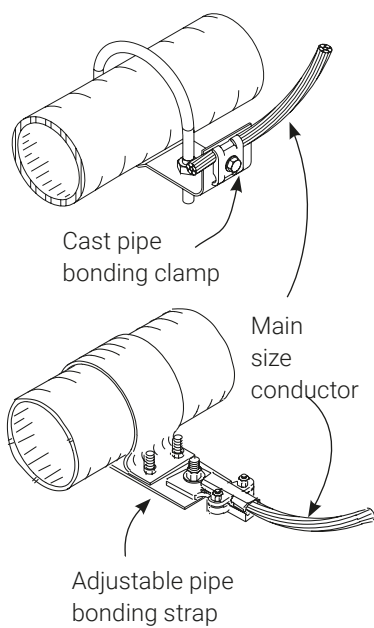

**Typical
Cable
Splicers**

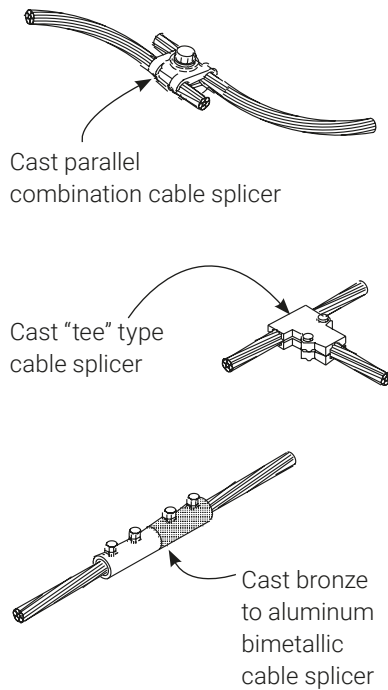

**Typical Roof
Drain Bond**

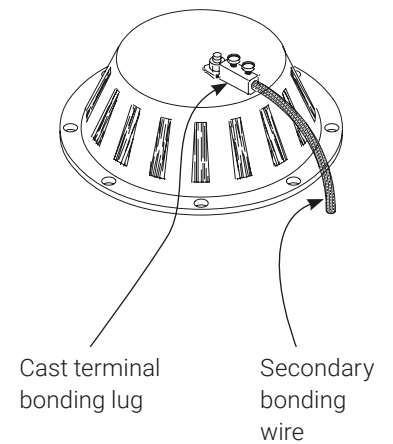

Conductors

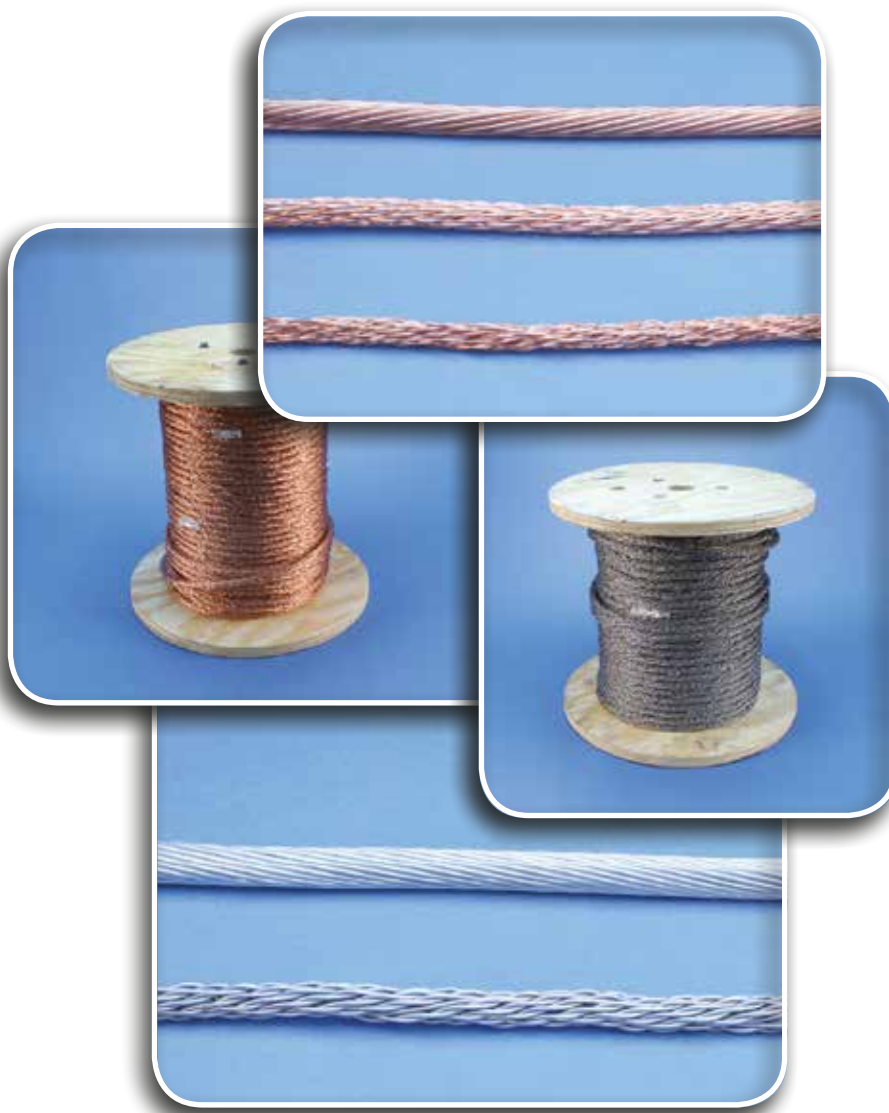

Conductors

Lightning Protection Conductors

Lightning protection conductors are designed to handle the high current, short duration electrical current flows of a lightning strike. nVent ERICO conductors are offered with aluminum, copper and tinned copper stranding. They are designed based on material composition and dimensional requirements defined in standards such as UL[®]96 and NFPA[®]780. Standard spool lengths are defined below. Cut to order (CTO) lengths are available for an additional charge. Secondary conductors are designed for bonding of metal objects such as gutters and window frames.

Additional conductors designed for heavy-duty stack applications are available on page 28. nVent also offers insulated conductors, for non-UL applications where separation distance and flashover are a concern.



Primary Aluminum Conductors



Part No.	Conductor Type	# of Strands	Wire Size Gauge (in)	Weight per 1000 ft. (lbs).	Approx. Diameter (in)	Circular Mils	Meets or Exceeds Requirement	Reel Size Options		
								250'	500'	CTO
LPA100	Smooth Weave	24	.064	102	.48	98,640	Class I	X	X	X
LPA101	Smooth Weave	26	.064	109	.52	106,680	Class I	-	X	X
LPA102	Smooth Weave	28	.064	115	.55	115,080	Class I	-	X	X
LPA105	Concentric	37	.076	204	.55	211,000	Class II	X	X	X

Conductors



Primary Copper Conductors



Part No.	Stranding	# of Strands	Strand Size (in)	Weight per 1000 ft. (lbs).	Approx. Diameter (in)	Circular Mils	Meets or Exceeds Requirement	Reel Size Options		
								250'	500'	CTO
LPC120	Smooth Weave	29	.045	192	.44	59,450	CLASS I	X	X	X
LPC120L	Tinned Smooth Weave	29	.045	192	.44	59,450	CLASS I	X	X	X
LPC122	Smooth Weave	32	.045	220	.48	65,600	CLASS I	X	X	X
LPC122L	Tinned Smooth Weave	32	.045	220	.48	65,600	CLASS I	X	X	X
LPC123	Smooth Weave	36	.045	240	.50	73,800	CLASS I	X	X	X
LPC124	Smooth Weave	40	.045	270	.53	82,000	CLASS I	X	X	X
LPC124L	Tinned Smooth Weave	40	.045	270	.53	82,000	CLASS I	-	X	X
LPC128	Smooth Weave	24	.064	340	.55	98,640	CLASS I	X	X	X
LPC125	Ropelay	24	.064	340	.45	98,640	CLASS I	X	-	X
LPC126R	Ropelay	28	.064	380	.47	115,080	CLASS II	X	X	X
LPC126RL	Tinned Ropelay	28	.064	380	.47	115,080	CLASS II	X	X	X
LPC127	Ropelay	32	.064	440	.53	131,520	CLASS II	X	X	X
LPC127L	Tinned Ropelay	32	.064	440	.53	131,520	CLASS II	X	-	X
LPC136	Concentric (3/0)	37	.068	520	.60	167,800	CLASS II	-	X	X
LPC137	Concentric (4/0)	37	.076	653	.65	211,600	CLASS II	X	-	X
LPC137L	Tinned Concentric (4/0)	37	.076	653	.65	211,600	CLASS II	X	-	X

Conductors

Secondary Aluminum Conductors

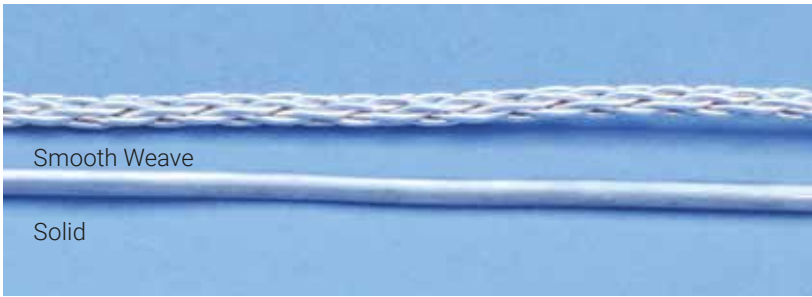

Reel Size Options

Part No.	Conductor Type	# of Strands	Strand Size (in)	Weight per 1000 ft. (lbs.)	Approx. Diameter (in)	Circular Mils	250'	500'	CTO
LPA140	Smooth Weave	10	.064	40	.35	41,100	-	X	X
LPA141	Soft Solid	1	.24	40	.24	41,740	X	X	X

Secondary Copper Conductors



Reel Size Options

Part No.	Conductor Type	# of Strands	Strand Size (in)	Weight per 1000 ft. (lbs.)	Approx. Diameter (in)	Circular Mils	250'	500'	CTO
LPC150	Smooth Weave	14	.045	92	.25	28,700	-	X	X
LPC151	Soft Solid	1	.162	80	.16	26,240	-	-	X
LPC154	Soft Solid	1	.325	204	.33	66,360	-	-	X
LPC154L	Tinned Soft Solid	1	.325	204	.33	66,360	-	-	X

Common Conductor Sizes	Circular Mils
#2 AWG	66,400
1/0	105,500
2/0	133,000
3/0	167,800
4/0	211,600
50 mm ²	98,676
70 mm ²	138,147

Common Strand Sizes	Diameter (in)
#17	0.045
#14	0.064



Air Terminals & Adaptors



Air Terminals & Adaptors



Air Terminals & Accessories

Air terminals, also known as strike termination devices, are offered in a range of base materials and surface platings. Terminals are provided with UNC threading to facilitate a minimum of 5 full threads of engagement. A full range of code compliant terminals are offered as well as copper-bonded steel air terminals for special applications. Additional air terminals are available in the heavy duty stack section on pages 28-29.

nVent ERICO copper-bonded steel air terminals are designed to be installed directly to structural steel in locations such as communication towers. A 4-1/2" threaded end with hardware is used to secure the terminal to a horizontal location where a continuous structure provides the path to ground. These terminals are not listed for use in UL applications. nVent can manufacture any length or style air terminal up to 144" under part number LPPPOINTCTO. Special pricing will apply.

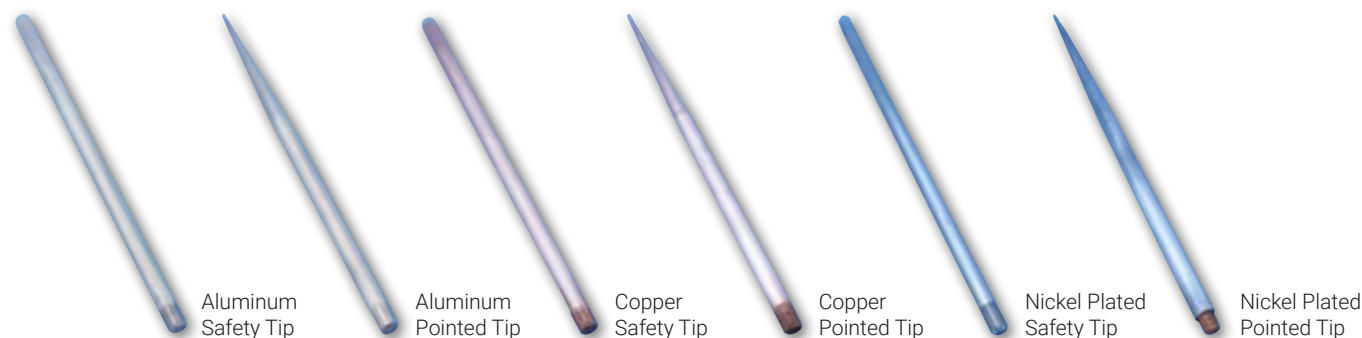

3/8" Points

Copper (Class I)					
Length (in)	Nickel Plated Pointed	Bare Pointed	Nickel Plated Safety Tip	Bare Safety Tip	Tinned Safety Tip
10	-	LPC201B	-	LPC201BST	-
12	LPC202	LPC202B	LPC202ST	LPC202BST	LPC202LST
15	LPC203	LPC203B	LPC203ST	LPC203BST	LPC203LST
18	LPC204	LPC204B	LPC204ST	LPC204BST	LPC204LST
24	LPC205	LPC205B	LPC205ST	LPC205BST	LPC205LST
30	LPC206	LPC206B	LPC206ST	LPC206BST	LPC206LST
36	LPC207	LPC207B	LPC207ST	LPC207BST	LPC207LST
48	LPC208	LPC208B	LPC208ST	LPC208BST	LPC208LST

5/8" Points

Aluminum (Class II)		Length (in)	Copper (Class II)				
Pointed	Safety Tip		Nickel Plated Pointed	Bare Pointed	Nickel Plated Safety Tip	Bare Safety Tip	Tinned Safety Tip
LPA241	LPA241ST	10	-	LPC241B	-	LPC241BST	-
LPA242	LPA242ST	12	LPC242	LPC242B	LPC242ST	LPC242BST	LPC242LST
LPA243	LPA243ST	15	LPC243	LPC243B	LPC243ST	LPC243BST	LPC243LST
LPA244	LPA244ST	18	LPC244	LPC244B	LPC244ST	LPC244BST	LPC244LST
LPA245	LPA245ST	24	LPC245	LPC245B	LPC245ST	LPC245BST	LPC245LST
LPA246	LPA246ST	30	LPC246	LPC246B	LPC246ST	LPC246BST	LPC246LST
LPA247	LPA247ST	36	LPC247	LPC247B	LPC247ST	LPC247BST	LPC247LST
LPA248	LPA248ST	48	LPC248	LPC248B	LPC248ST	LPC248BST	LPC248LST

1/2" Points

Aluminum (Class I)			Copper (Class II)				
Pointed	Safety Tip	Length (in)	Nickel Plated Pointed	Bare Pointed	Nickel Plated Safety Tip	Bare Safety Tip	Tinned Safety Tip
LPA221	LPA221ST	10	-	LPC221B	-	LPC221BST	-
LPA222	LPA222ST	12	LPC222	LPC222B	LPC222ST	LPC222BST	LPC222LST
LPA223	LPA223ST	15	LPC223	LPC223B	LPC223ST	LPC223BST	LPC223LST
LPA224	LPA224ST	18	LPC224	LPC224B	LPC224ST	LPC224BST	LPC224LST
LPA225	LPA225ST	24	LPC225	LPC225B	LPC225ST	LPC225BST	LPC225LST
LPA226	LPA226ST	30	LPC226	LPC226B	LPC226ST	LPC226BST	LPC226LST
LPA227	LPA227ST	36	LPC227	LPC227B	LPC227ST	LPC227BST	LPC227LST
LPA228	LPA228ST	48	LPC228	LPC228B	LPC228ST	LPC228BST	LPC228LST

16 mm (5/8") Points

Length	Aluminum	Copper
	Safety Tip	Bare Safety Tip
.5 M (19.7")	LPA244MST	LPC244MBST
1 M (39.4")	LPA247MST	LPC247MBST

MST/MBST points are manufactured to the length typically specified in IEC installations, yet have the UNC threading for use with bases included within this catalog. Points are provided with lock washer for additional securing to the air terminal base.

Air Terminals & Adaptors

Tubular Points



Tubular points are suitable for class 1 installations. They can be installed in either a 5/8" air terminal base (NC threads) or directly attached to a structure such as an air conditioning unit (3 in² contact pad). Additional lengths available on request.

Length (in)	Aluminum		Copper	
	3 in ² Contact Pad	NC Threads	3 in ² Contact Pad	NC Threads
12	LPA252	LPA262	LPC252	LPC262
18	LPA254	LPA264	LPC254	LPC264
24	LPA255	LPA265	LPC255	LPC265

Extension Rods

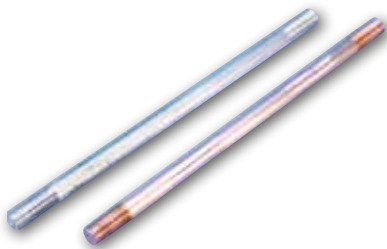

Extension rods are provided with both ends NC threaded. Pieces are cut to order (CTO) in lengths up to 144".

Diameter (in)	Aluminum	Copper	Stainless
3/8	-	LPC271CTO	-
1/2	LPA272CTO	LPC272CTO	LPS272CTO
5/8	LPA273CTO	LPC273CTO	LPS273CTO

Standard N.C. thread each end CTO - Length "Cut to Order"

Spring Point Adaptor

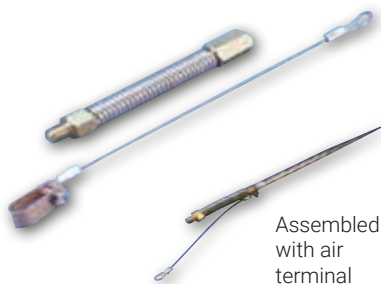

Assembled with air terminal

Spring point adaptors are designed to provide a flexible attachment point for air terminals. The adaptors can be used on points from 10" to 24" in length.

Aluminum		Copper	
1/2"	5/8"	1/2"	5/8"
LPA27512	LPA27558	LPC27512	LPC27558



Air Terminals & Adaptors

Adjustable (Swivel) Point Adaptors



Part Number Coding

LPC 282 3F 2M

Material Code	Connection Type - Numeric Identifier	Connection Type Code	
		Female	Male
LPA - Aluminum	3/8 to 3/8 - 281	3/8 = 3F	3/8 = 3M
LPC - Copper	3/8 to 1/2 - 282	1/2 = 2F	1/2 = 2M
LPS - Stainless	1/2 to 1/2 - 283	5/8 = 5F	5/8 = 5M
	1/2 to 5/8 - 284		
	5/8 to 5/8 - 285		

Examples

LPA2845F2M: Aluminum swivel, 5/8" female to 1/2" male
LPC2823F2M: Copper swivel, 3/8" female to 1/2" male

Couplings & Adaptors



Part Number Coding

LPC 292 3F 2M

Material Code	Connection Type - Numeric Identifier	Connection Type Code	
		Female	Male
LPA - Aluminum	3/8 to 3/8 - 291	3/8 = 3F	3/8 = 3M
LPC - Copper	3/8 to 1/2 - 292	1/2 = 2F	1/2 = 2M
LPS - Stainless	1/2 to 1/2 - 293	5/8 = 5F	5/8 = 5M
	1/2 to 5/8 - 294		
	5/8 to 5/8 - 295		

Examples

LPA2945F2M: Aluminum coupler, 5/8" female to 1/2" male
LPC2913F3M: Copper coupler, 3/8" female to 3/8" male

Extendable Right-Angle Adaptor

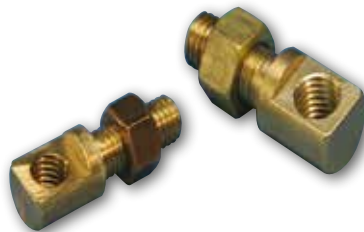

Extendable adapter provides an additional 2" offset when used with air terminal bases. Can be coupled with LPx291 - LPx295 series to provide a total of 3" offset.

Thread Size (in)	Aluminum	Copper
3/8	-	LPC29638
1/2	LPA29612	LPC29612
5/8	LPA29658	LPC29658

Safety Ball Air Terminal

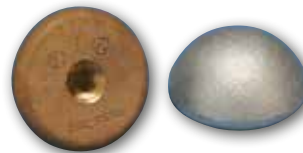

Safety ball attachments are designed to provide a level of protection against impalement in high traffic areas. They are designed to be installed with the dual threaded extension rods.

Thread Size (in)	Aluminum	Copper
3/8	-	LPC27838
1/2	LPA27812	LPC27812
5/8	LPA27858	LPC27858

Copper-Bonded Air Terminals



Copper-bonded steel air terminals for use in non-UL® applications such as tower lightning protection. Designed to be installed directly to structural steel and provided with mounting hardware.

Part No.	Diameter (in)	Length (in)
LPCC584NC4	5/8	48
LPCC585NC4	5/8	60
LPCC586NC4	5/8	72
LPCC588NC4	5/8	96
LPCC5810NC4	5/8	120
LPCC346NC4	3/4	72
LPCC348NC4	3/4	96
LPCC3410NC4	3/4	120

Point Bases, Braces & Accessories

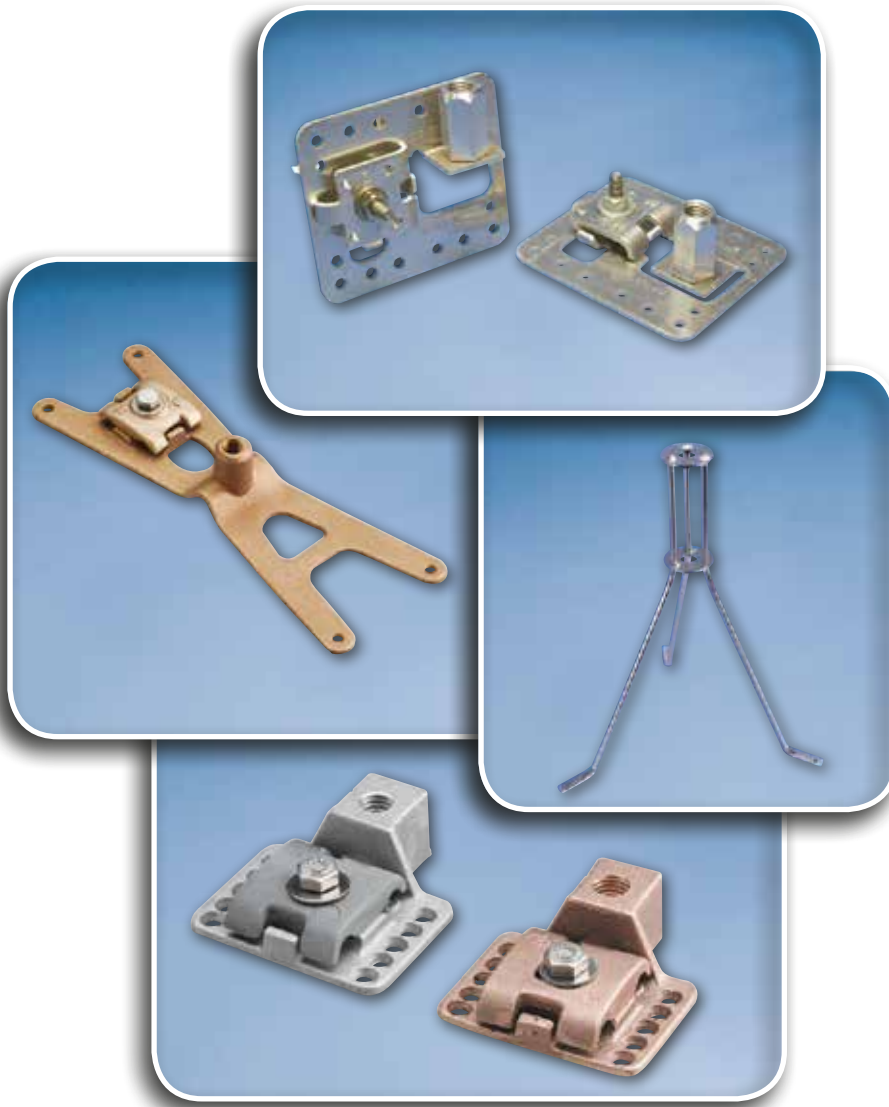

Point Bases, Braces & Accessories



Air Terminal Bases & Braces

nVent offers a comprehensive line of stamped and cast air terminal bases to address a variety of installation application needs. All bases have a cable range starting from the smallest class 1 conductor to the largest class 2 conductor (see pages 14-16 for a dimensional cross reference). Additional air terminal bases specifically addressing heavy-duty stack installations are included in the industrial stack equipment section.

Universal Air Terminal Base

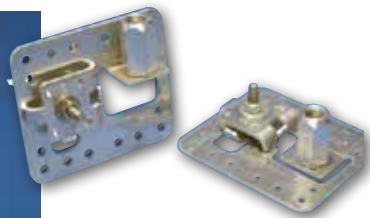

Bronze, tinned bronze or aluminum stamped adhesive base for use on flat, vertical or sloping surfaces. Positive single bolt tension for multi-directional cable clamping. Four.281" diameter mounting holes for bolts or screws. Air terminal support tab is field adjustable for any angle as shown from 0-90°, eliminating the need for swivel adaptors.

Point Dia. (in)	Aluminum	Copper	Tinned Copper
3/8	-	LPC30238	LPC302L38
1/2	LPA30212	LPC30212	LPC302L12
5/8	LPA30258	LPC30258	LPC302L58

- Field adjusting tool (part number LPT302)
- Also available pre-configured for vertical applications (eg. LPA30212V, aluminum 1/2" point, factory set for vertical applications)

Horizontal Air Terminal Base



Bronze or aluminum stamped adhesive base for use on narrow flat surfaces. Positive single bolt tension for multi-directional cable clamping. Four.200" diameter mounting holes for bolts or screws.

Point Dia. (in)	Aluminum	Copper
3/8	-	LPC30438
1/2	LPA30412	LPC30412
5/8	LPA30458	LPC30458

Vertical/Horizontal Air Terminal Base



Bronze or aluminum cast adhesive point base for use on flat or vertical surfaces. Positive single bolt tension for multi-directional cable clamping. Four.250" diameter mounting holes for bolts or screws.

Point Dia. (in)	Aluminum	Copper	Tinned Copper
3/8	-	LPC30538	LPC305L38
1/2	LPA30512	LPC30512	LPC305L12
5/8 Horizontal Mount	LPA30558H	LPC30558H	LPC305L58H
5/8 Vertical Mount	LPA30558V	LPC30558V	LPC305L58V

Also available with a completely through vertical threaded air terminal hole (eg. LPA30512THRU)

Point Bases, Braces & Accessories

Horizontal Mount Point Base



Bronze or aluminum cast adhesive point base for use on flat surfaces when no penetration may be made for anchoring. Positive single bolt tension cable clamping. For use with hot pitch, roofing compound or commercial adhesive on built-up roof surfaces or other locations.

Point Dia. (in)	Aluminum	Copper
3/8	-	LPC30938
1/2	LPA30912	LPC30912
5/8	LPA30958	LPC30958

Vertical Mount Point Base



Bronze or aluminum cast point base for use on vertical surface with horizontal or vertical run of cable. Positive bolt tension cable clamping with two .281" diameter mounting holes for bolts or screws.

Point Dia. (in)	Aluminum	Copper	Tinned Copper
3/8	-	LPC31838	PC318L38
1/2	LPA31812	LPC31812	PC318L12
5/8	LPA31858	LPC31858	PC318L58

Ridge/Sloping Roof Point Base

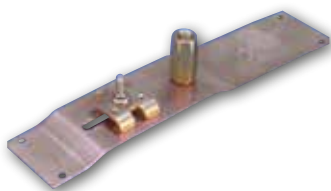

Copper or aluminum point base for use on ridged roofs. Positive bolt tension cable clamping. 12" long base with four .200" diameter holes provided for mounting.

Point Dia. (in)	Aluminum	Copper
3/8	-	LPC31238
1/2	LPA31212	LPC31212
5/8	LPA31258	LPC31258

Ridge/Sloping Roof Point Base

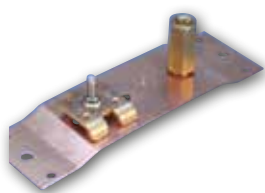

Copper or aluminum point base for use on narrow surface or roof edge. 8" long base with four .200" diameter holes for nails or screw anchors.

Point Dia. (in)	Aluminum	Copper
3/8	-	LPC31538
1/2	LPA31512	LPC31512
5/8	LPA31558	LPC31558



Point Bases, Braces & Accessories

Offset Vertical Mount Point Base



Bronze or aluminum cast point base for use on vertical surface with horizontal or vertical run of cable. Point attachment offset 2" from surface to clear overhang of wall cap or cover. Positive bolt tension cable clamping with two .281" diameter mounting holes for bolts or screws.

Point Dia. (in)	Aluminum	Copper
3/8	-	LPC31938
1/2	LPA31912	LPC31912
5/8	LPA31958	LPC31958

Inline Point Base



Bronze or aluminum straight inline point base of hexagonal metal stock. Two 5/16" set screws anchor cable within base.

Point Dia. (in)	Aluminum	Copper
3/8	-	LPC32138
1/2	LPA32112	LPC32112
5/8	LPA32158	LPC32158

Pipe Mount Point Base & Cable Clamp Support



Bronze or aluminum cast pipe mount point for vertical pipe or cable pipe bond. When used as a point support it may be used with or without cable run on pipe or will allow point to stand off pipe to use type 321 point to cable connector. Maximum mounting diameter of 1.75".

Part Number	Material	Nominal Pipe Diameter Range (in)
LPA330	Aluminum	.75 - 1.75
LPC330	Copper	.75 - 1.75
LPC330L	Tinned Copper	.75 - 1.75
LPA331	Aluminum	1.50 - 2.00
LPC331	Copper	1.50 - 2.00
LPC331L	Tinned Copper	1.50 - 2.00

See page 26 for pipe size reference chart.

Cone Roof Point Base



Bronze or aluminum cast point base for use on cone shaped metal surface. No cable connector. Use three bolts or screws for anchoring.

Point Dia. (in)	Aluminum	Copper
3/8	-	LPC33938
1/2	LPA33912	LPC33912
5/8	LPA33958	LPC33958

Horizontal Bond Point Base



Bronze or aluminum cast point base for mounting directly to horizontal structural steel surface. Eight square inches of surface contact with four .20" diameter holes and two .25" holes provided for bolts or metal screws.

Point Dia. (in)	Aluminum	Copper
3/8	-	LPC34038
1/2	LPA34012	LPC34012
5/8	LPA34058	LPC34058

Ridge Mount Point Base



Bronze or aluminum cast point base for use on ridged roof, sloping or flat surfaces. May be easily formed. Positive bolt tension cable clamping with four .250" diameter holes provided for nails or metal screws.

Point Dia. (in)	Aluminum	Copper
3/8	-	LPC34538
1/2	LPA34512	LPC34512
5/8	LPA34558	LPC34558

Also available with a completely through vertical threaded air terminal hole for through ridge applications (eg. LPA34512THRU)

Point Bases, Braces & Accessories

Sloped Roof Point Base

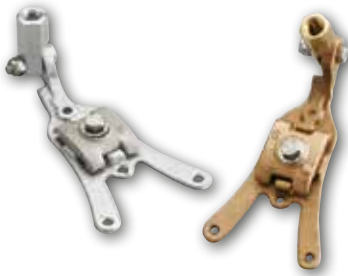

Bronze or aluminum cast point base for use on ridged roof, sloping or flat surfaces. Positive bolt tension cable clamping with four .187" diameter holes provided for nails or metal screws.

Point Dia. (in)	Aluminum	Copper
3/8	-	LPC34738
1/2	LPA34712	LPC34712
5/8	LPA34758	LPC34758

Standing Seam Point Base

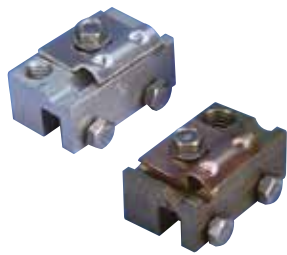

Bronze or aluminum machined point base for standing seam roofing systems. Bottom groove 1/2" wide by 3/4" deep to secure on seam with two set screws. Adjustable cable connector for conductor runs either parallel or perpendicular to the seam.

Point Dia. (in)	Aluminum	Copper
3/8	-	LPC34838
1/2	LPA34812	LPC34812
5/8	LPA34858	LPC34858

Pipe Mount Point Base



Bronze or aluminum cast pipe mount point base with point coupling for horizontal pipe. Provided with cable clamp to support cable beneath pipe. Can be applied to vertical pipe with LP296 right angle point coupler. Maximum mounting diameter of 2.50".

Point Dia. (in)	Aluminum	Copper	Tinned Copper
3/8	-	LPC37138	LPC371L38
1/2	LPA37112	LPC37112	LPC371L12
5/8	LPA37158	LPC37158	LPC371L58

See page 26 for pipe size reference chart.



Penetrating Base

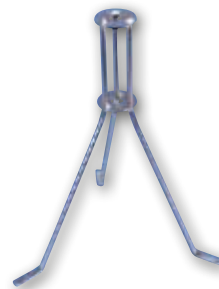

Galvanized steel tripod braces for additional support of long air terminals. Constructed of 1/4" mild steel with heavy section washer guides. All joints welded prior to galvanizing. Two .14" diameter mounting holes per leg furnished for installation. Suitable for 3/8", 1/2" and 5/8" diameter points.

Non-Penetrating Base

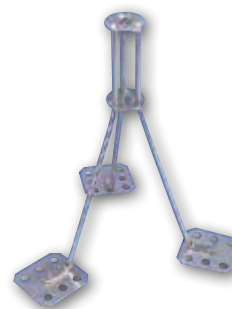

Galvanized steel tripod braces for additional support of long air terminals on flat or gently sloping surface when no penetration may be made for anchoring. Constructed of 1/4" mild steel with heavy section washer guides. All joints welded prior to galvanizing. For use with hot pitch, roofing compound or commercial adhesive on membrane surface or other locations. Suitable for 3/8", 1/2" and 5/8" diameter points.

Penetrating Support	Non-penetrating Support	Length (in)	Maximum Air Terminal Dimensions (in)
LPG35058	LPG36058	14	5/8 X 24
LPG35158	LPG36158	18	5/8 X 30
LPG35258	LPG36258	24	5/8 X 40
LPG35358	LPG36358	36	5/8 X 60
LPG35458	LPG36458	48	5/8 X 84

Point Bases, Braces & Accessories

PIPE MOUNT POINT BASE



Bronze or aluminum cast pipe mount point base with point coupling for horizontal pipe. Can be applied to vertical pipe with LP296 right angle point coupler. Mounts on pipe diameters from 1.50" to 2.50".

Point Dia. (in)	Aluminum	Copper	Tinned Copper
3/8	-	LPC37238	LPC372L38
1/2	LPA37212	LPC37212	LPC372L12
5/8	LPA37258	LPC37258	LPC372L58

STRAP TYPE POINT OR CABLE HOLDER

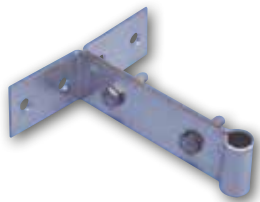

Copper or aluminum strap type point or cable holder. Made of heavy tinned copper or bare aluminum strap formed to draw tight under bolt tension. Will hold solid rod points or full size cables offset from flat or curved mounting surface. Available in various offset distances.

Series 669

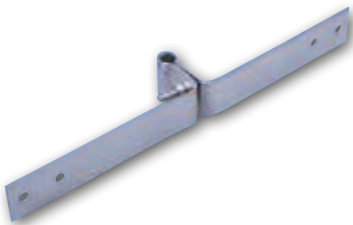

Series 670

Part No.	Material	Offset Distance (in)	Attachment Wing Length (in)
LPA669	Aluminum	4	2
LPC669	Tinned Copper	4	2
LPA670	Aluminum	1	6
LPC670	Tinned Copper	1	6

STRAP TYPE POINT OR CABLE TO PIPE HOLDER



Copper or aluminum strap type point or cable to pipe holder. Made of heavy tinned copper or bare aluminum strap formed to draw tight under bolt tension to hold solid rod points or full size cables close to pipe. Available in standard pipe sizes 1-1/2", 2", 3" and 4". Other sizes available upon request.

Series 671-674

Pipe Size (in)	Aluminum	Copper
1-1/2 inside (1.900 O.D.)	LPA671	LPC671
2 inside (2.375 O.D.)	LPA672	LPC672
3 inside (3.500 O.D.)	LPA673	LPC673
4 inside (4.500 O.D.)	LPA674	LPC674

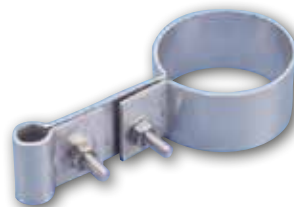

Series 675-678

Pipe Size (in)	Aluminum	Copper
1-1/2 inside (1.900 O.D.)	LPA675	LPC675
2 inside (2.375 O.D.)	LPA676	LPC676
3 inside (3.500 O.D.)	LPA677	LPC677
4 inside (4.500 O.D.)	LPA678	LPC678

Pipe Reference Chart

NPS (in)	Outer Diameter (in)
3/8	.675
1/2	.840
3/4	1.050
1	1.315
1-1/4	1.660
1-1/2	1.900
2	2.375
2-1/2	2.875
3	3.500
3-1/2	4.000
4	4.500
5	5.563
6	6.625
8	8.625
10	10.750
12	12.750

Industrial Stack Equipment

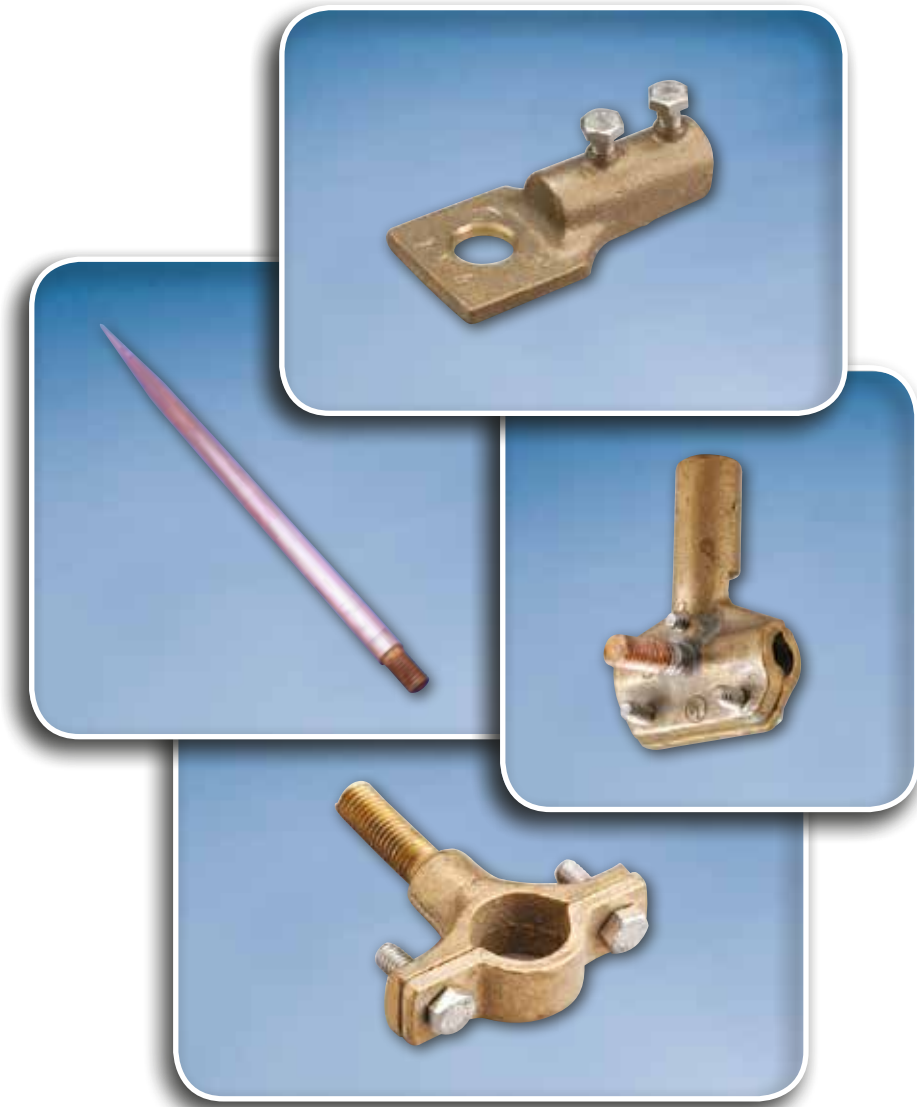

Industrial Stack Equipment



HEAVY-DUTY STACK EQUIPMENT

Lightning protection components for heavy-duty stacks, as defined by UL96, require a minimum of class II materials. All air terminals 5/8" & 3/4" are produced with a 5/8" thread for compatibility with the air terminal bases. All lead covered conductors, air terminals and components denoted by "LPLC" have a 1/16" thick covering of lead.

LEAD COVERED & COPPER CONDUCTORS



Copper Conductors

Part No.	Stranding	# of Strands	Wire Size (in)	Weight per 1000 ft. (lbs).	Circular Mills	Meets or Exceeds Requirements
LPC401CTO	Ropelay	28	.064	380	115,080	Class II
LPC404CTO	Concentric	19	.106	653	211,600	Class II-4/0

Lead Covered Copper Conductors

Part No.	Stranding	# of Strands	Wire Size (in)	Weight per 1000 ft. (lbs).	Circular Mills	Meets or Exceeds Requirements
LPLC401CTO	Concentric	19	.084	1,380	115,080	Class II
LPLC404CTO	Concentric	19	.106	1,983	211,600	Class II-4/0

BARE COPPER AIR TERMINALS



Solid copper air terminals made from high conductivity copper rod with tapered point and standard UNC threads.

5/8" Air Terminals (5/8" thread)

Length (in)	Copper
60	LPC415
72	LPC416
84	LPC417
96	LPC418

3/4" Air Terminals (5/8" thread)

Length (in)	Copper
18	LPC421
24	LPC422
36	LPC423
48	LPC424
60	LPC425
72	LPC426
84	LPC427
96	LPC428

For shorter length see page 18.

Industrial Stack Equipment



LEAD COVERED AIR TERMINALS

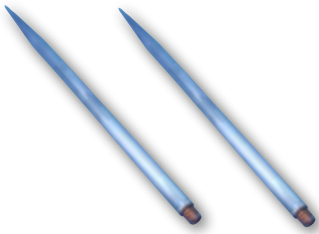

Solid copper air terminals made from high conductivity copper rod with a 1/16" thick lead sheath, tapered point and standard UNC threads.

5/8" Air Terminals (5/8" thread)

Length (in)	Lead-Covered
18	LPLC411
24	LPLC412
36	LPLC413
48	LPLC414
60	LPLC415
72	LPLC416
84	LPLC417
96	LPLC418

3/4" Air Terminals (5/8" thread)

Length (in)	Lead-Covered
18	LPLC421
24	LPLC422
36	LPLC423
48	LPLC424
60	LPLC425
72	LPLC426
84	LPLC427
96	LPLC428

STAINLESS STEEL AIR TERMINALS

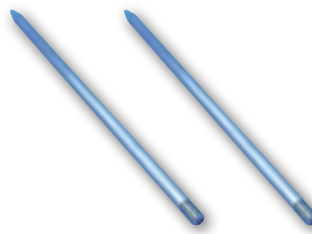

Stainless steel air terminals made from 304 grade stainless steel rod, with tapered point and standard UNC threads.

5/8" Air Terminals (5/8" thread)

Length (in)	Stainless Steel
18	LPS411
24	LPS412
36	LPS413
48	LPS414
60	LPS415
72	LPS416
84	LPS417
96	LPS418

3/4" Air Terminals (5/8" thread)

Length (in)	Stainless Steel
18	LPS421
24	LPS422
36	LPS423
48	LPS424
60	LPS425
72	LPS426
84	LPS427
96	LPS428

AIR TERMINAL BASES

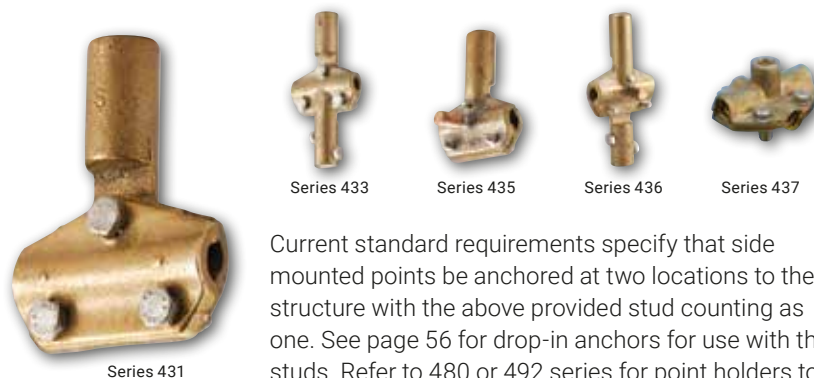

Current standard requirements specify that side mounted points be anchored at two locations to the structure with the above provided stud counting as one. See page 56 for drop-in anchors for use with the studs. Refer to 480 or 492 series for point holders to be used as the second required anchor.

Part No.	Material	Stud Length (in)
LPC431	Brass	-
LPLC431	Lead Coated Brass	-
LPC433	Brass	-
LPLC433	Lead Coated Brass	-
LPC435SH	Brass	7/8
LPC435LG	Brass	1-1/2
LPLC435SH	Lead Coated Brass	7/8
LPLC435LG	Lead Coated Brass	1-1/2
LPC436SH	Brass	7/8
LPC436LG	Brass	1-1/2
LPLC436SH	Lead Coated Brass	7/8
LPLC436LG	Lead Coated Brass	1-1/2
LPC437SH	Brass	7/8
LPC437LG	Brass	1-1/2
LPLC437SH	Lead Coated Brass	7/8
LPLC437LG	Lead Coated Brass	1-1/2

Industrial Stack Equipment

CABLE SPLICERS



Part No.	Material
LPC441	Brass
LPLC441	Lead Coated Brass
LPC443	Brass
LPLC443	Lead Coated Brass
LPC446	Brass
LPLC446	Lead Coated Brass
LPC448	Brass
LPLC448	Lead Coated Brass

Suitable for cables from 2/0 to 4/0 in size

SPECIAL BONDING ACCESSORIES

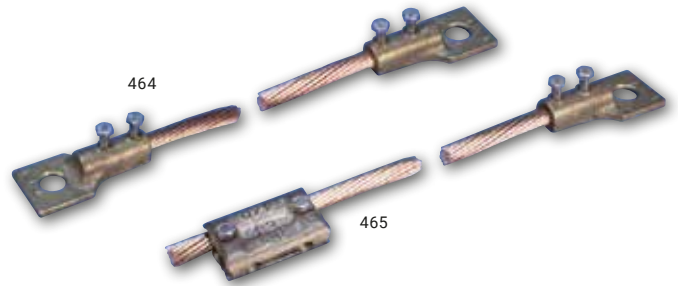

Part No.	Lug 1	Lug 2	Connector	Material
LPC464	LPC451	LPC451	-	Brass
LPLC464	LPLC451	LPLC451	-	Lead Coated Brass
LPC465	LPC451	-	LPC441	Brass
LPLC465	LPLC451	-	LPLC441	Lead Coated Brass

Standard cable length = 36"

Standard cable = LPC401

For 4/0 cable size insert "40" following 464 in the part number. (eg. LPC46440 for copper lug, 4/0 cable size)

BONDING FITTINGS



Part No.	Material	Contact Area (in ²)	Hole Size (in)	Use with Cable #
LPC451	Brass	3	13/16	LPC401/LPC404
LPLC451	Lead Coated Brass	3	13/16	LPLC401/LPLC404
LPS451	Stainless Steel	3	13/16	LPC401/LPC404

BONDING CLAMPS (LPC466)



Cast bronze universal cable to rebar bonding clamp. Fits cable sizes through 250 MCM to reinforcing bars up through #9 (1.128").

REBAR BONDS



Embedded rebar connection assembly consists of a flush mount brass plate with 1/2" tapped hole connecting Part No. LPC401 or LPC404 bare copper cable to rebar bonding clamp(s). Three feet of cable provided per rebar clamp. Use this product in conjunction with Part No. LPC468, exposed downlead to flush plate connectors.

Part No.	Rebar Clamp 1	Rebar Clamp 2	Conductor 1
LPC467	-	-	-
LPC467X1	LPC466	-	LPC401
LPC467X2	LPC466	LPC466	LPC401
LPC46740X1	LPC466	-	LPC404
LPC46740X2	LPC466	LPC466	LPC404

HANDRAIL TO POINT



Part No.	Material	Pipe Diameter (in)	Air Terminal Size (in)
LPC456	Brass	1.0 - 2.0	5/8 & 3/4
LPS456	Stainless Steel	1.0 - 2.0	5/8 & 3/4

Industrial Stack Equipment

BARE BRASS CONNECTOR



Cast cable connector for connecting flush rebar plate to bare copper downlead cable. Available in cast bronze (LPC468) and lead covered (LPLC468).

PIPE FASTENERS (LPC478)



Bare bronze, protector pipe fastener. Provided with 1/2" diameter x 7/8" long threaded stud for anchoring.

STEEL YOKE (LPS469)



Stainless steel yoke for connections to iron bands. For use where lead covered copper cables extend over bands. Drilled and tapped for 1/2" threaded stud. Use with Series LPC481, LPC482 or LPC483. Designed to fit over a single 3/8" thick band (LPS469).

POINT & CABLE FASTENERS



Bronze 2-bolt cap type point fastener for use with bare copper points. Provided with 1/2" threaded stud for anchoring.

GROUNDING BUSBAR (LPC475)



LPC475 used as a ground bus to connect bottom end of downlead to customer provided ground tail at column base. Standard holes provided for 1/2" bolt size connections and anchors (three on the face and one on each wing).

Part No.	Air Terminal Size (in)	Stud Length (in)	Material
LPC48058SH	5/8	7/8	Brass
LPC48058LG	5/8	1-1/2	Brass
LPC48034SH	3/4	7/8	Brass
LPC48034LG	3/4	1-1/2	Brass
LPLC48058SH	5/8	7/8	Lead Coated Brass
LPLC48058LG	5/8	1-1/2	Lead Coated Brass
LPLC48034SH	3/4	7/8	Lead Coated Brass
LPLC48034LG	3/4	1-1/2	Lead Coated Brass

DOWNLEAD PROTECTOR (LPC477)

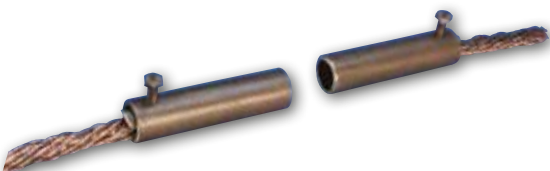

Copper tube protector for use where stranded cables are subject to displacement or damage. Protectors are 8 feet long and ship with a set screw and wedge at each end to bond cable to tube.

PINCH TYPE CABLE FASTENERS



Pinch type cable fastener. Provided with 1/2" threaded stud for anchoring. For use with LPC401/LPLC404

Part No.	Stud Length (in)	Material
LPC481SH	7/8	Brass
LPC481LG	1-1/2	Brass
LPLC481SH	7/8	Lead Coated Brass
LPLC481LG	1-1/2	Lead Coated Brass

Industrial Stack Equipment

2-BOLT CABLE FASTENERS



2-bolt cap type cable fastener. Provided with 1/2" threaded stud for anchoring. For use with LPC401 thru LPLC404

POINT & CABLE INSERTS



Lay-in point or cable holder. Series LPC492 for use with bare copper or stainless points. Series LPLC492 for use with lead covered steel points. Lay-in brick construction.

Part No.	Stud Length (in)	Material
LPC482SH	7/8	Brass
LPC482LG	1-1/2	Brass
LPLC482SH	7/8	Lead Coated Brass
LPLC482LG	1-1/2	Lead Coated Brass

Part No.	Material	Air Terminal Size (in)
LPC49258	Copper	5/8
LPC49234	Copper	3/4
LPLC49258	Lead Covered Copper	5/8
LPLC49234	Lead Covered Copper	3/4

CABLE TO METAL FASTENER (LPC483)



Bare bronze cable to metal surface fastener. Provided with 1/2" x 2" stainless steel mounting bolt. May be used with Part No. LPS469 iron band yoke.

CONCRETE INSERT (LPC48412)



Cast bronze insert; provided with 1/2"-13 internal thread for placement in concrete during construction. Use with standard length stud 7/8"

See page 56 for additional anchors

Connectors, Clamps, Plates & Lugs

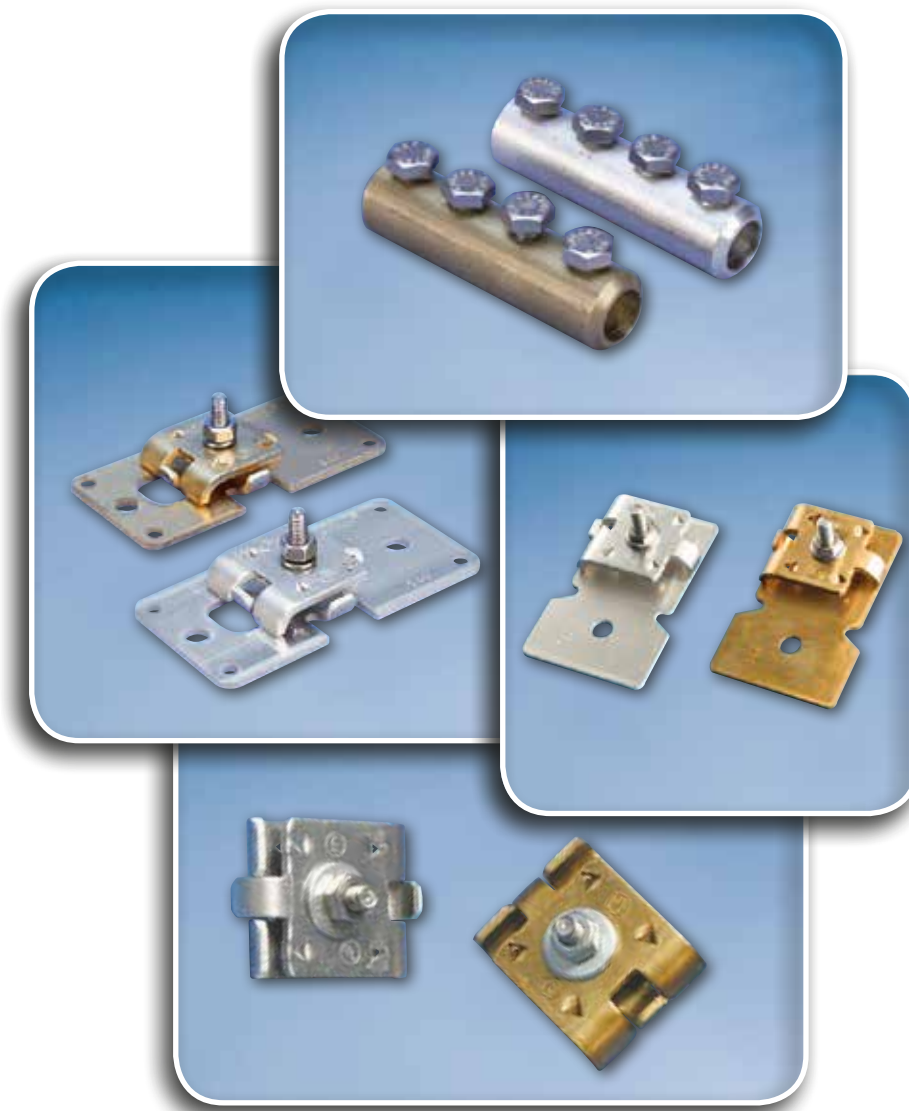

Connectors, Clamps, Plates & Lugs

CABLE CONNECTORS

COPPER AND ALUMINUM COMPRESSION CABLE SPLICERS



Copper or aluminum connector with compression type fingers to crimp over cable. Made from 14 gauge copper or 10 gauge aluminum sheet stock. For use on Class I structures only.

Part No.	Material	Conductor Range
LPA501	Aluminum	all class 1 conductors
LPC501	Copper	all class 1 conductors
LPA503	Aluminum	all class 1 conductors
LPC503	Copper	all class 1 conductors
LPA505	Aluminum	all class 1 conductors
LPC505	Copper	all class 1 conductors

BRONZE AND ALUMINUM UNIVERSAL PARALLEL CABLE SPLICERS

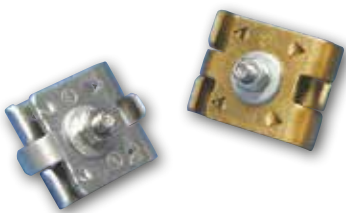

Stamped bronze or aluminum universal parallel cable connector. Positive single bolt tension grip on cables or wire. Total contact length 1-1/2"

Part No.	Material	Conductor Range
LPA502	Aluminum	Class 1 to 4/0
LPC502	Bronze	Class 1 to 4/0
LPC502A	Aluminum / Bronze with stainless separation	Class 1 to 4/0
LPC502L	Tinned Bronze	Class 1 to 4/0

ALUMINUM AND TINNED BRONZE SECONDARY CABLE CONNECTOR



Stamped aluminum or tinned bronze secondary cable connector. Can be used to bond sheet metal bodies such as gutters or fixed ladders. Conductor range varies by application.

Part No.	Material
LPA508	Aluminum
LPC508L	Tinned Copper

CAST BRONZE AND ALUMINUM TEE CABLE SPLICER



Cast bronze or aluminum tee cable connector with positive bolt tension grip on cables. For use with all full size cables.

Part No.	Material	Conductor Range
LPA510	Aluminum	Class 1 to 4/0
LPC510	Bronze	Class 1 to 4/0
LPC510L	Tinned Bronze	Class 1 to 4/0

CAST BRONZE AND ALUMINUM STRAIGHT CABLE SPLICER



Machined bronze or aluminum cable connector. For use with all cable sizes. Straight cable splicer with 4 bolts for pressure on each cable.

Part No.	Material	Conductor Range
LPA513	Aluminum	Class 1 to 4/0
LPC513	Bronze	Class 1 to 4/0
LPC513L	Tinned Bronze	Class 1 to 4/0

Connectors, Clamps, Plates & Lugs



CAST BRONZE AND ALUMINUM UNIVERSAL PARALLEL CABLE SPLICERS



Cast bronze or aluminum universal parallel cable connector. Positive single or dual bolt tension grip on cables or wire. Total contact length 1-1/2"(516) or 2"(517).

Part No.	Material	Conductor Range
LPA516	Aluminum	Secondary to 4/0
LPC516	Bronze	Secondary to 4/0
LPC516A	Aluminum / Bronze with stainless separation	Secondary to 4/0
LPA517	Aluminum	Secondary to 4/0
LPC517	Bronze	Secondary to 4/0
LPC517L	Tinned Bronze	Secondary to 4/0

CAST BRONZE AND ALUMINUM UNIVERSAL PARALLEL CABLE CONNECTORS



Cast bronze or aluminum universal parallel cable connector. Positive single or double bolt tension grip on cables or wires. Total contact length 2" (527) or 4"(528).

Part No.	Material	Conductor Range
LPA527	Aluminum	Class 1 to 4/0
LPC527	Bronze	Class 1 to 4/0
LPA528	Aluminum	Class 1 to 4/0
LPC528	Bronze	Class 1 to 4/0

BONDING PLATES

Bonding plates are required to have a minimum of 3 square inches of contact area. 8 square inches are required when the structural steel is to be used as the primary down conductor for the lightning protection system. For crimp style connectors, fingers or tabs crimp over cable for direct contact. Crimp style bonding plates can only be used in class 1 locations. Mechanical style bonding connections can be used in both Class 1 & Class 2 applications. For standard crimp cable holders, see the 810 series on page 54.

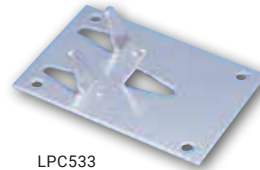

LPC533

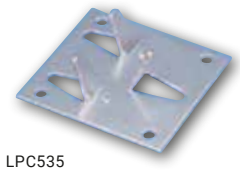

LPC535

Part No.	Material	Connection Type	Construction	Contact Area (Square in.)
LPA533	Aluminum	Crimp	Stamped	8
LPC533	Copper	Crimp	Stamped	8
LPC533L	Tinned Copper	Crimp	Stamped	8
LPA535	Aluminum	Crimp	Stamped	4
LPC535	Copper	Crimp	Stamped	4
LPC535L	Tinned Copper	Crimp	Stamped	4

The 536 series combines a cast bronze or aluminum flat metal bonding plate (Part Numbers LPC532 or LPA532) with mild steel welding plate 1/4" x 4" x 4" for attachment to steel columns or beams when no holes may be made in steel member. Steel plate to be welded to steel column or beam. The bonding plates are attached to the plate with four 1/2-20 hex head bolts.

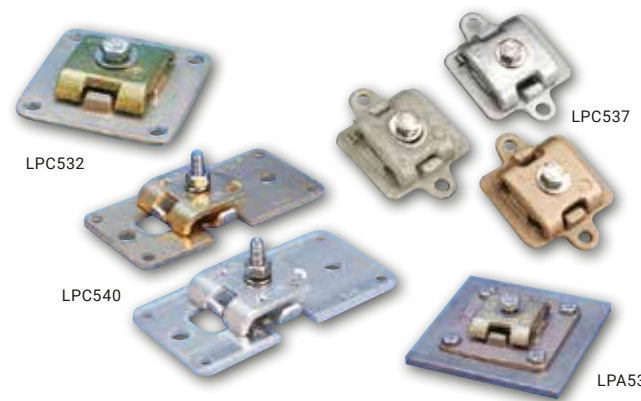

LPC532

LPC537

LPC540

LPA536

Part No.	Material	Connection Type	Construction
LPA532	Aluminum	Mechanical	Cast
LPC532	Copper	Mechanical	Cast
LPC532L	Tinned Copper	Mechanical	Cast
LPA536	Aluminum	Mechanical	Cast
LPC536	Copper	Mechanical	Cast
LPA537	Aluminum	Mechanical	Cast
LPC537	Copper	Mechanical	Cast
LPC537L	Tinned Copper	Mechanical	Cast
LPA540	Aluminum	Mechanical	Stamped
LPC540	Copper	Mechanical	Stamped
LPC540A	Aluminum / Bronze with stainless separation	Mechanical	Stamped
LPC540L	Tinned Copper	Mechanical	Stamped

Connectors, Clamps, Plates & Lugs

BONDING LUGS

CAST AND STAMPED BONDING LUGS



Cast or stamped bonding lugs that can be used with class 1 up to 4/0 cable. Various bolt hole sizes are available. 3 square inches provides the contact area for a main-sized bond.

Bolt Diameter (in)	Material	Part No	
		Cast	Stamped
1/4	Aluminum	-	LPA55314
1/4	Copper	-	LPC55314
1/4	Tinned Copper	-	LPC553L14
3/8	Aluminum	LPA55138	LPA55338
3/8	Copper	LPC55138	LPC55338
3/8	Tinned Copper	LPC551L38	LPC553L38
1/2	Aluminum	LPA55112	LPA55312
1/2	Copper	LPC55112	LPC55312
1/2	Tinned Copper	LPC551L12	LPC553L12

BEAM BONDING CLAMPS

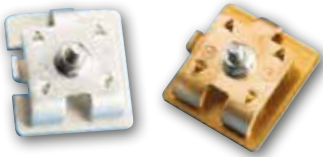

Part No.	Material
LPA554	Aluminum
LPC554	Copper
LPC554L	Tinned Bronze

Stamped bonding clamp for all main sized conductor to 5/8" beam thickness

CAST BRONZE AND ALUMINUM TERMINAL BONDING LUG



Cast bronze or aluminum terminal bonding lug with set screw pressure on cables and wires. Lug hole for 1/4" diameter bolt. For use with all secondary bonding cables and wires.

Part No.	Material
LPA555	Aluminum
LPC555	Bronze
LPC555L	Tinned Bronze

BEAM/FLANGE BONDING CLAMPS

Beam/Purlin Flange Bonding Clamps

Cast bronze or aluminum universal cable to beam flange or purlin flange bonding clamp. Requires no holes in heavy steel member. For use with all full size cables and bonding cables and wires.

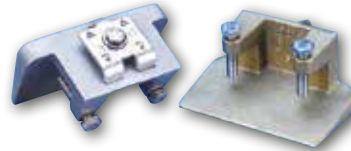

Provide 8 square inches of contact area. For use with up to 1" beam thickness.

Part No.	Material
LPA557	Aluminum
LPC557	Bronze
LPC557L	Tinned Bronze



Single bolt tension on up to 5/8" beam thickness.

Part No.	Material
LPA559	Aluminum
LPC559	Bronze
LPC559L	Tinned Bronze



Part No.	Material
LPA858	Aluminum
LPC858	Copper
LPC858L	Tinned Bronze

Cast bronze or aluminum cable clamp for fastening to flat metal objects such as I-beams, angle irons, channel irons, etc. Positive bolt tension draws tight on steel member. For use with all full size cables, miniature cables and bonding wires.



Connectors, Clamps, Plates & Lugs

PIPE GROUNDING CLAMPS

Cast Grounding Clamp

For use with all full size cables. 570 Series recommended also for rebar bonding. See page 26 for a pipe size cross reference chart.



Part No.	Material	Nominal Pipe Diameter Range (in)
LPA570	Aluminum	.50 - 1.50
LPC570	Copper	.50 - 1.50
LPC570L	Tinned Copper	.50 - 1.50
LPA571	Aluminum	2.00 - 2.70
LPC571	Copper	2.00 - 2.70
LPC571L	Tinned Copper	2.00 - 2.70
LPA580	Aluminum	.75 - 1.32
LPC580	Copper	.75 - 1.32
LPC580L	Tinned Copper	.75 - 1.32

STAMPED GROUNDING CLAMPS

Copper or aluminum pipe bonding clamp, made of stainless steel u-bolt with stainless strap and aluminum or copper cable connector. Suitable for pipe sizes from 1.5" to 6". Can be used with all cable sizes and incorporated with Series 321 for point mounting. For pipe sizes greater than 6" refer to Series 588 and 590.



Part No.	Cable Connector Material	Nominal Pipe Diameter Range (in)
LPA5962	Aluminum	1.90 - 2.63
LPC5962	Copper	1.90 - 2.63
LPA5963	Aluminum	2.63 - 3.63
LPC5963	Copper	2.63 - 3.63
LPA5964	Aluminum	4.00 - 4.63
LPC5964	Copper	4.00 - 4.63
LPA5966	Aluminum	5.00 - 6.63
LPC5966	Copper	5.00 - 6.63

See page 26 for pipe reference chart.



Connectors, Clamps, Plates & Lugs

STRAP GROUNDING CLAMP

Strap tinned copper or aluminum pipe bonding clamp. Suitable for pipe diameters from 6.63" to 8.63" (588 series) and from 8.63" to 10.75" (590 Series) Other sizes available upon request. For use with all full size cables.

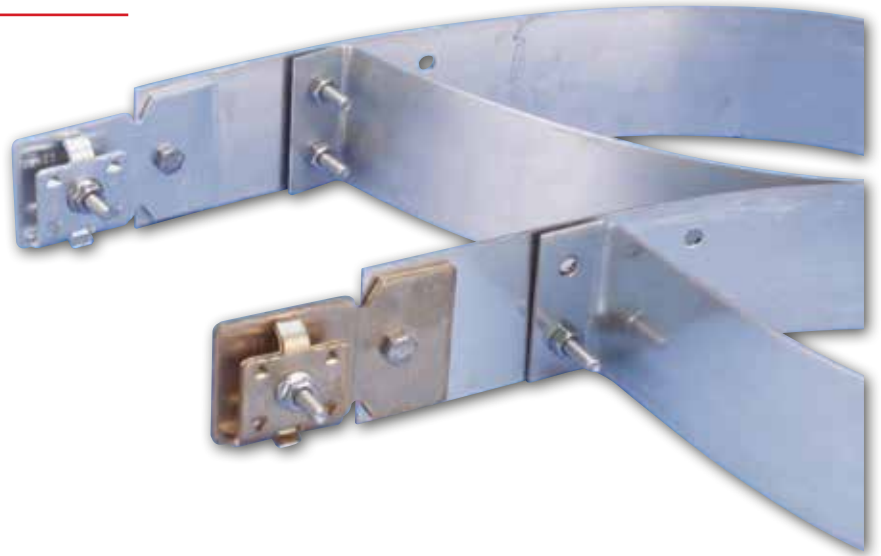
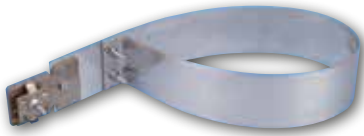

Part No.	Material
LPA588	Aluminum
LPC588	Bronze
LPA590	Aluminum
LPC590	Tinned Bronze

CROSS-RUN CABLE CONNECTOR

Cast bronze or aluminum cross-run or 4-way cable connector. Four bolts for positive bolt tension grip on cables. For use with all full size cables up to 4/0.



Part No.	Material
LPA595	Aluminum
LPC595	Bronze
LPC595L	Tinned Bronze

BI-METALLIC CONNECTOR (LPA598)



Machined aluminum bi-metallic connector for making connections between copper and aluminum cables in straight run. Two-bolt tension grip on each cable end. For use with all full size cables up to 4/0.

Through Roof, Through Wall & Cable Protectors



Through Roof, Through Wall & Cable Protectors



THROUGH WALL & THROUGH ROOF CONNECTIONS

Through roof assemblies provide a connection point to transition the external lightning protection system to a concealed installation within the structure. Down conductors are then routed to a point near the ground where the conductors are transitioned outside the building to a grounding point. This is accomplished by using through wall assemblies. As an alternative, a through-roof assembly can provide a transition to a point within the structure where bonding to structural steel is used as the down conductor.

Most assemblies are provided with gaskets to seal the structure from moisture ingress. Additional protection can be provided with sealers that are selected based on the specific roofing material.

THROUGH WALL/ROOF CONNECTION



Bronze or aluminum cast concealed point base assemblies. Can be used with an air terminal or all thread. Positive bolt tension cable clamping for cables or wires, accepts one or two of any combination of full size and/or miniature bonding wires or cables in a parallel manner. Furnished with washer and standard UNC nut for secure connections.

Rod Thread	Aluminum	Copper	Bi-metallic
3/8"		LPC61038	LPC610BI38
1/2"	LPA61012	LPC61012	LPC610BI12
5/8"	LPA61058	LPC61058	LPC610BI58

THROUGH WALL/THROUGH ROOF CONNECTION ASSEMBLIES



Through roof and through wall assemblies allow for a weatherproof junction between lightning protection components and concealed downloads. A variety of connection methods and materials are offered to accommodate all field conditions. Always consult the roof manufacturer or owner for proper flashing materials.

Part No.	Materials	Connector 1	Connector 2	Rod Length (in)
LPA619	Al-Al	LPA61012	LPA61012	12
LPC619	Cu-Cu	LPC61012	LPC61012	12
LPC619A	Cu-Al	LPC61012	LPA61012	12
LPA620	Al-Al	LPA61012	LPA55312	12
LPC620	Cu-Cu	LPC61012	LPC55312	12
LPC620A	Cu-Al	LPC61012	LPA55312	12
LPA621	Al-Al	LPA55312	LPA55312	12
LPC621	Cu-Cu	LPC55312	LPC55312	12
LPC621A	Cu-Al	LPC55312	LPA55312	12
LPA622	Al-Al	LPA55312	LPA55312	6
LPC622	Cu-Cu	LPC55312	LPC55312	6
LPC622A	Cu-Al	LPC55312	LPA55312	6

All Through Walls / Through Roofs utilize 1/2" stainless steel all-thread

Through Roof, Through Wall & Cable Protectors

THROUGH ROOF CONNECTION ASSEMBLIES



Part No.	Materials	Top Connector	Bottom Connector	Point Diameter (in)	Rod Length (in)
LPA62412	Al-Al	LPA2932F2F	LPA61012	1/2	12
LPA62458	Al-Al	LPA2942F5F	LPA61012	5/8	12
LPC62438	Cu-Cu	LPC2923F2F	LPC61012	3/8	12
LPC62412	Cu-Cu	LPC2932F2F	LPC61012	1/2	12
LPC62458	Cu-Cu	LPC2942F5F	LPC61012	5/8	12
LPC624A12	Al-Cu	LPA2932F2F	LPC61012	1/2	12
LPC624A58	Al-Cu	LPA2942F5F	LPC61012	5/8	12
LPA62612	Al-Al	LPA2932F2F	LPA32112	1/2	12
LPA62658	Al-Al	LPA2942F5F	LPA32112	5/8	12
LPC62638	Cu-Cu	LPC2923F2F	LPC32112	3/8	12
LPC62612	Cu-Cu	LPC2932F2F	LPC32112	1/2	12
LPC62658	Cu-Cu	LPC2942F5F	LPC32112	5/8	12
LPC626A12	Al-Cu	LPA2932F2F	LPC32112	1/2	12
LPC626A58	Al-Cu	LPA2942F5F	LPC32112	5/8	12
LPA62812	Al-Al	LPA2832F2F	LPA61012	1/2	12
LPA62858	Al-Al	LPA2842F5F	LPA61012	5/8	12
LPC62838	Cu-Cu	LPC2823F2F	LPC61012	3/8	12
LPC62812	Cu-Cu	LPC2832F2F	LPC61012	1/2	12
LPC62858	Cu-Cu	LPC2842F5F	LPC61012	5/8	12
LPC628A12	Al-Cu	LPA2832F2F	LPC61012	1/2	12
LPC628A58	Al-Cu	LPA2842F5F	LPC61012	5/8	12

All Through Walls / Through Roofs utilize 1/2" all-thread

ALL THREAD ROD

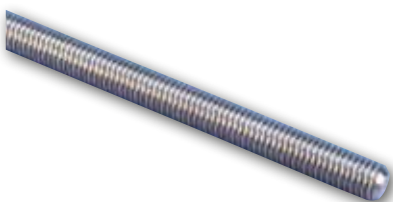

Stainless steel all thread rod available either cut to order or in standard lengths. All threading to UNC standard.

Part No.	Diameter (in)	Length (in)
LPS661CTO	3/8	Cut to order
LPS662CTO	1/2	Cut to order
LPS66212	1/2	12
LPS66218	1/2	18
LPS663CTO	5/8	Cut to order

THROUGH ROOF PVC ASSEMBLIES



Through roof assemblies offer a parallel connection for above roof connection and either a flat-mount rod and cable holder or an inline splice. These products are available with either a full 1" PVC tube (full assembly) or a cap to fit over 1" PVC (upper connection). The outer dimension of the PVC tube is 1-5/16".

Part No.	Materials	Connector 1	Connector 2	Rod Length (in)
Full Assembly				
LPA66418	Al-Al	LPA61012	LPA30412	18
LPC66418	Cu-Cu	LPC61012	LPC30412	18
LPC664A18	Al-Cu	LPA61012	LPC30412	18
LPA66424	Al-Al	LPA61012	LPA30412	24
LPC66424	Cu-Cu	LPC61012	LPC30412	24
LPC664A24	Al-Cu	LPA61012	LPC30412	24
Upper Connection				
LPA664	Al-Al	LPA61012	LPA32112	-
LPC664	Cu-Cu	LPC61012	LPC32112	-
LPC664A	Al-Cu	LPA61012	LPC32112	-
LPC664BI	Al-Cu or Cu-Cu	LPC610BI12	LPC32112	-
LPC664L	Tinned Cu-Tinned Cu	LPC610L12	LPC321L12	-

All Through Walls / Through Roofs utilize 1/2" all-thread



Through roof assemblies offer a parallel connection for above roof connection and an 8 in² flat mount (UNC version) and an 8 in² flat mount with a straight splice (standard version). These products come with a full 1.5" PVC tube (full assembly). The outer dimension of the PVC tube is 1-7/8".

Part No.	Materials	Connector 1	Connector 2	Rod Length (in)
LPC66518	Cu-Cu	LPC61012	LPC34012 / LPC32112	18
LPC66518BI	Al or Cu-Cu	LPC610BI12	LPC34012 / LPC32112	18
LPC66518NC	Cu-Cu	LPC61012	LPC34012	18
LPC66518NCBI	Tinned Cu-Tinned Cu	LPC610BI12	LPC34012	18
LPC66524	Cu-Cu	LPC61012	LPC34012 / LPC32112	24
LPC66524BI	Al or Cu-Cu	LPC610BI12	LPC34012 / LPC32112	24
LPC66524NC	Cu-Cu	LPC61012	LPC34012	24
LPC66524NCBI	Tinned Cu-Tinned Cu	LPC610BI12	LPC34012	24

All Through Walls / Through Roofs utilize 1/2" all-thread

Through Roof, Through Wall & Cable Protectors

POLYVINYLCHLORIDE PROTECTOR (LPP743)



Polyvinylchloride protector for cables through 5/8" diameter. For use where stranded cables are subject to displacement or damage. Protector 1" O.D. PVC Pipe, 10' long. Secure with Part No. LPC807 or LPC808 fasteners.

GALVANIZED SHEET STEEL PROTECTOR (LPP745)

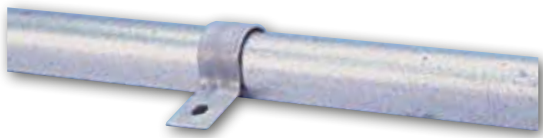

Galvanized sheet steel protector for cables through 3/4" diameter. For use where stranded cables are subject to displacement or damage. Provided with 4 single hole clips.

PVC PROTECTOR

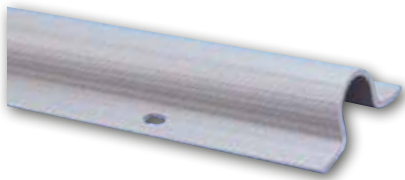

PVC protector for cables of all sizes up to 1" or 2". For use where stranded cables are subject to displacement or damage. Two sizes available in 8' lengths. Each section able to overlap for longer lengths.

Part No.	Dimensions
LPP74718	1" x 8'
LPP74728	2" x 8'

Grounding Accessories



Grounding Accessories

GROUNDING ACCESSORIES

nVent is a worldwide leader providing grounding accessories that help ensure the dissipation of energy. The nVent ERICO brand of grounding accessories are made from high-quality materials that offer superior corrosion resistance and long-lasting performance. They are easy to install with innovative and time-saving features to accommodate a variety of customer needs.

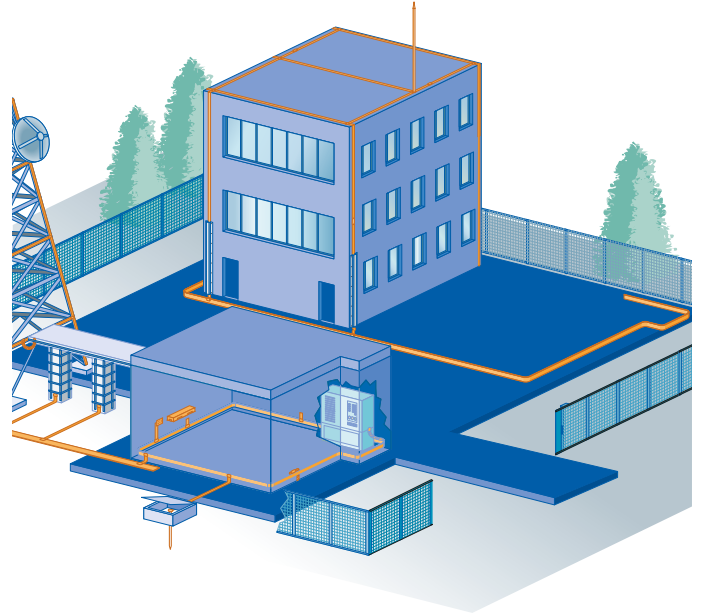

WELDING PLATE



LPP667

Mild steel welding plate 1/4" x 4" x 4" for attachment to steel columns or beams when no holes may be made in steel member. Steel plate to be welded to steel column or beam. Fabricated with four 1/4-20 tapped holes, 2-1/4" apart on center.

GROUNDING PLATE



LPC682

Cast bronze grounding plate for equipment, machinery, or structure grounding points. May be installed flush in concrete floor or wall. Face measures 3-1/4" square with four holes for 1/2" bolts on 1-3/4" center. Cable connection under bolt tension. For all standard cables.

GROUNDING RECEPTACLES



LPC680

LPC681

Cast bronze aircraft type static grounding receptacle with standard pin connection and chain retained cover plate. Install flush with finished floor surface. Designed to couple directly to 3/4" sectional type ground rod or 3/4" extension rod. LPC681 comes with additional spring clip.

BONDING ASSEMBLIES



LPP691 bar with LPC122 copper cable (for Class I systems)

LPP692 bar with LPC126R copper cable (for Class II systems)

LPP693 bar with LPC137 copper cable (4/0)

Prefabricated cable to reinforcing bar bonding assemblies. Catalog numbered assembly includes 18" of #4 reinforcing bar with an exothermic weld to 5 ft. of copper cable. Wire tie or weld bar to construction steel before pouring concrete and route cable tail to down lead or ground lead location.

Grounding Accessories

GROUND PLATE

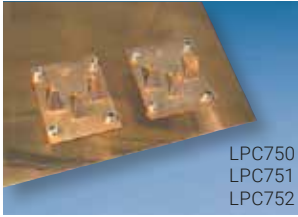

LPC750
LPC751
LPC752

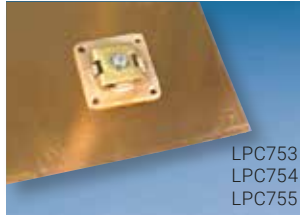

LPC753
LPC754
LPC755

20 gauge copper ground plates for providing ground location in areas where ground rods are not drivable, such as rocky soil.

Part No.	Width (in)	Length (in)	No. of Attachments	Type of Attachment
LPC750	12	24	2	LPC535
LPC751	18	18	2	LPC535
LPC752	36	36	2	LPC535
LPC753	12	24	1	LPC532
LPC754	18	18	1	LPC532
LPC755	36	36	1	LPC532

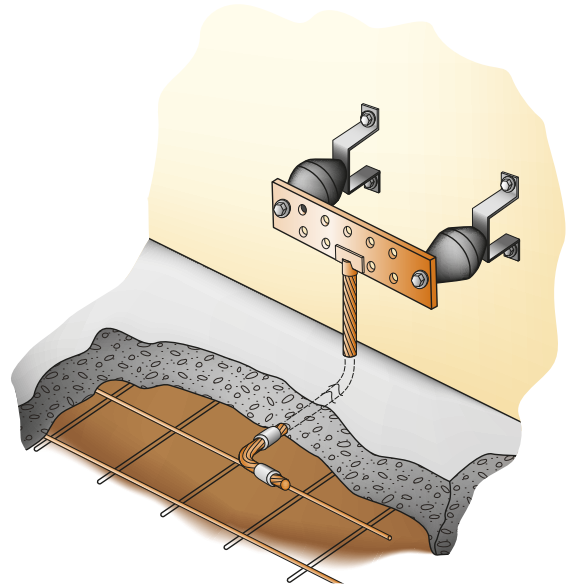

BUSBARS

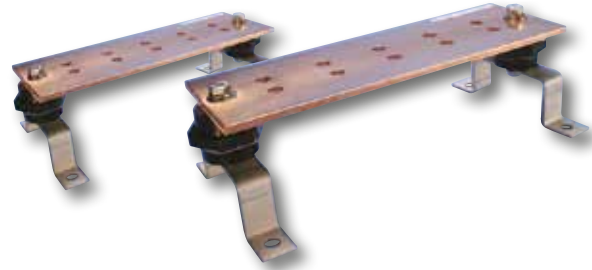

GROUND ROD CLAMPS



LPC790

Made of high-conductivity bronze and features stainless steel bolts and threaded, high-strength rivet nuts. Accommodates ground rods from 1/2" to 3/4" and conductors from class 1 to 4/0.



LPC795

U-Bolt ground rod clamp with high conductivity bronze casting and high strength stainless steel u-bolt. Three inch contact between clamp and cable. Accommodates ground rods from 1/2" to 1" and cable from class 1 to 4/0.

E G B A 1 4 4 1 2 C C

ERICO
Ground Bar
Designation

Configuration

- A = Insul & Brkt
- B = Brkt only
- C = None (Bar only)
- D = Insul only

Thickness

- 18 = 1/8"
- 38 = 3/8"
- 58 = 5/8"
- 14 = 1/4"
- 12 = 1/2"
- 34 = 3/4"

Width

- 1 = 1"
- 2 = 2"
- 3 = 3"
- 4 = 4"
- 5 = 5"
- 6 = 6"
- 7 = 7"
- 8 = 8"
- 9 = 9"

Pig Tail Length Ft. (Empty if none)

- A = 1 N = 16
- B = 2 O = 17
- C = 3 P = 18
- D = 4 Q = 19
- E = 5 S = 24
- F = 6 T = 25
- G = 7 U = 26
- H = 8 V = 27
- J = 9 W = 32
- K = 10 X = 34
- L = 11 Y = 36
- M = 12 Z = 38

ERICO Cable Code (Empty if none)

- 1K = #4 Sol Tin
- 1T = #2 Sol Tin
- 2C = 1/0
- SG = 2/0
- 2L = 3/0
- 2Q = 4/0
- 2V = 250 KCM
- 3D = 350 KCM
- 3Q = 500 KCM
- 4L = 750 KCM

Tin Plating (Empty if none)



- T = Tinned

Hole Pattern

Length (rounded to the nearest inch, up to 96 inch max.)

The chapter highlights a portion of the grounding products nVent offers. A complete listing is available in the Grounding & Bonding Catalog.

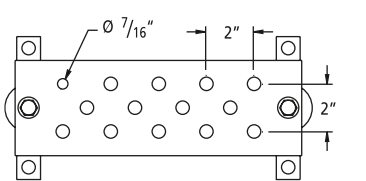
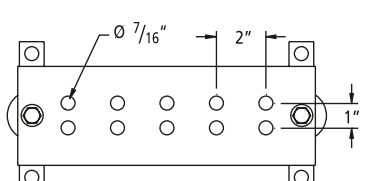
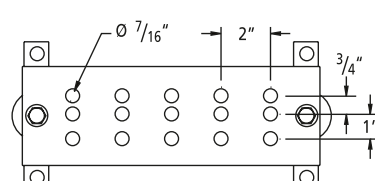
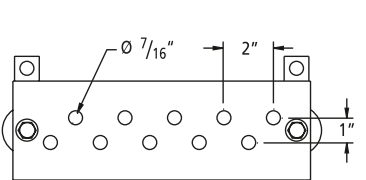
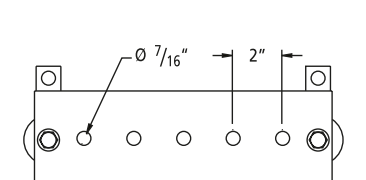
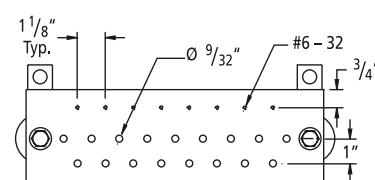
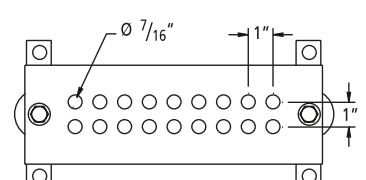
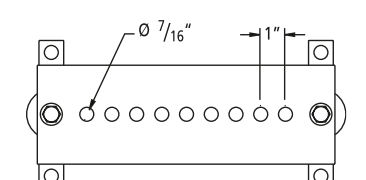
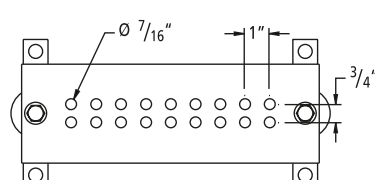
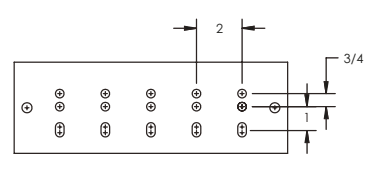
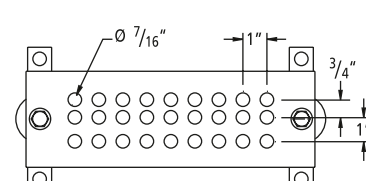
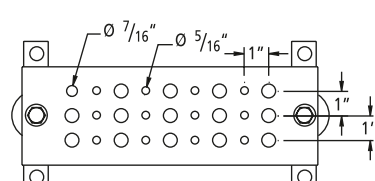
Grounding Accessories

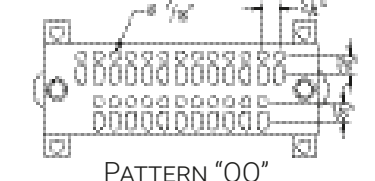
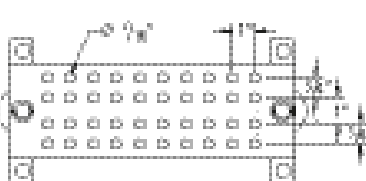
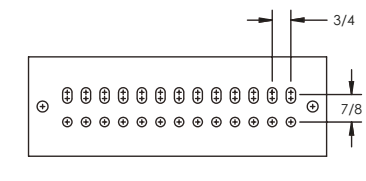
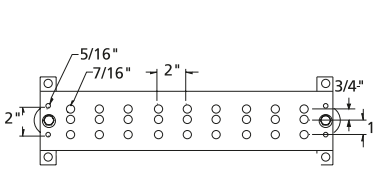
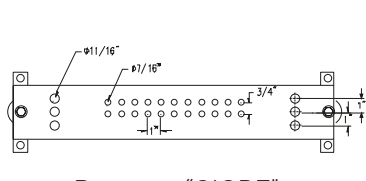
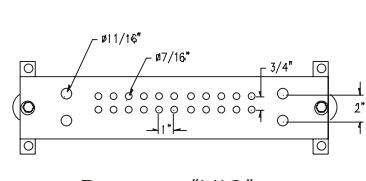
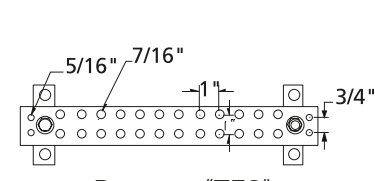
 <p>PATTERN "AA"</p>	 <p>PATTERN "BB"</p>	 <p>PATTERN "CC"</p>
 <p>PATTERN "DD"</p>	 <p>PATTERN "EE"</p>	 <p>PATTERN "FF"</p>
 <p>PATTERN "GG"</p>	 <p>PATTERN "HH"</p>	 <p>PATTERN "JJ"</p>
 <p>PATTERN "KK"</p>	 <p>PATTERN "LL"</p>	 <p>PATTERN "MM"</p>
 <p>PATTERN "NN"</p>	 <p>PATTERN "PP"</p>	 <p>PATTERN "QQ"</p>
 <p>PATTERN "RR"</p>	 <p>PATTERN "SS"</p>	 <p>PATTERN "CCSKY"</p>
 <p>PATTERN "CIGBE"</p>	 <p>PATTERN "HIG"</p>	 <p>PATTERN "TES"</p>

Grounding Accessories

GROUND RODS

COPPER-BONDED GROUND RODS

Pointed Rods

- 99.9% pure electrolytic copper coating
- Molecular bond to nickel-sealed high strength steel core
- Tensile strength greater than 80,000 PSI on 1/2" & 90,000 PSI on 5/8" and 3/4"
- Minimum copper coating of 10 mils on rods listed to UL® 467

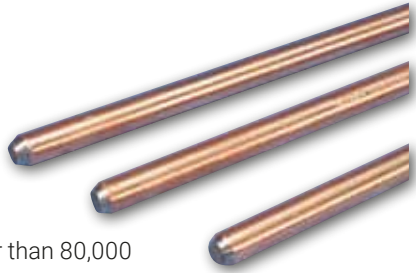

Part No.	Nominal Diameter (in)	Length (ft)	Plating Thickness (mils)	Weight per 100 rods (lbs)	Standard Bundle
611380	1/2	8	10	553	5
615880	5/8	8	10	680	5
613480	3/4	8	10	1,000	5
611300	1/2	10	10	738	5
615800	5/8	10	10	844	5
613400	3/4	10	10	1,240	5

COPPER-BONDED GROUND RODS

Sectional, Threaded Rods



- Cold-rolled threads with continuous, unbroken grain flows preserve copper coating and are stronger than cut threads
- Electrolytically copper-bonded steel: copper is molecularly bonded to nickel-sealed, high-strength steel cores
- Minimum copper coating of 10 mils on rods listed to UL® 467

Part No.	Nominal Diameter (in)	Length (ft)	Plating Thickness (mils)	Weight per 100 rods (lbs)	Standard Bundle
631300	1/2	10	10	688	5
631380	1/2	8	10	540	5
633400	3/4	10	10	1,240	5
633480	3/4	8	10	1,000	5
635800	5/8	10	10	844	5
635880	5/8	8	10	680	5

SOLID COPPER RODS



Part No.	Diameter (in)	Length (ft)
LPC700	1/2	8
LPC702	1/2	10
LPC704	5/8	8
LPC706	5/8	10
LPC711	3/4	10

CHEMICAL GROUND RODS

Chemical ground electrodes, part of the ERICO line of Facility Electrical Protection products from nVent, provide a low impedance ground in locations of high soil resistivity and dry soil conditions.

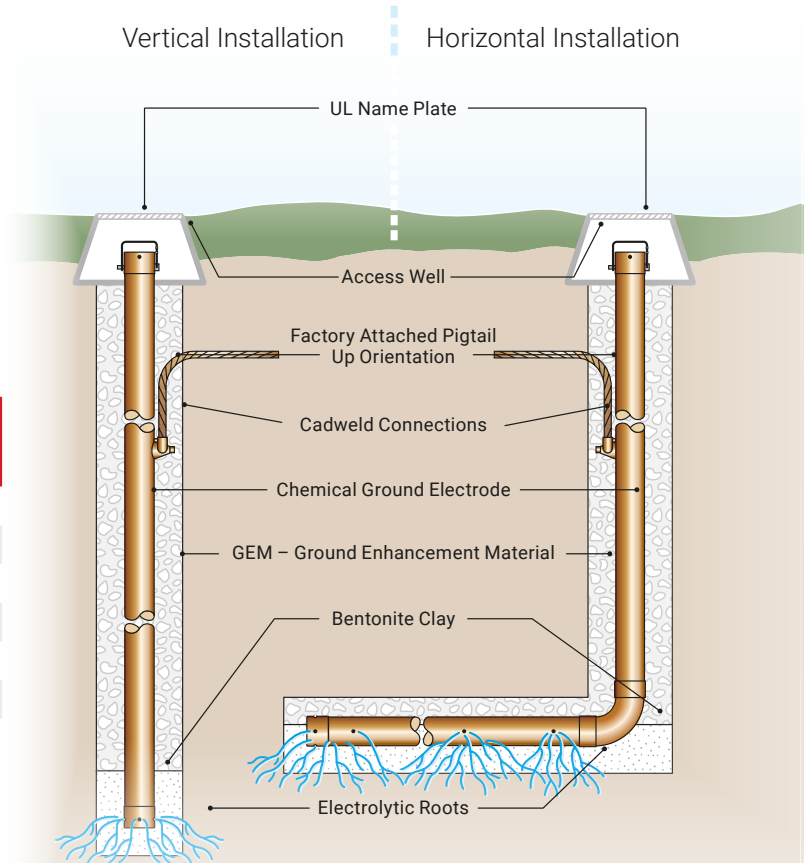

Chemical Ground Electrodes can be installed either vertically or horizontally. Chemical electrodes are available in a range of standard and custom configurations. They can be purchased individually or part of a complete kit.

Ground Rod Accessories

THREADLESS COMPRESSION COUPLERS FOR COPPER-BONDED POINTED RODS



- Made of high-strength silicon bronze
- Tapered so when rod is driven into coupling, parts compress to form a conductive connection
- UL & CSA® Listed



Part No.	Nominal Rod Diameter (in)	Unit Weight (lbs)	Unit Weight (kg)	Standard Package
CC12F	1/2 (full)	0.240	0.108	25
CC58	5/8	0.300	0.134	25
CC34	3/4	0.450	0.202	25

COUPLERS FOR THREADED RODS



- High-strength couplings are threaded bronze and chamfered at both ends for easy driving
- Corrosion-resistant couplings ensure permanent, low-resistance copper-to-copper connections
- UL® & CSA® Listed

Part No.	Nominal Rod Diameter (in)	Standard Package
CR12S	1/2 (full)	25
CR58	5/8	25
CR34	3/4	25
CR100	1	1



High Density Polyethylene Inspection Wells (HDPE)



T416BH

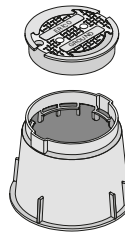

T416B

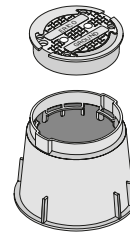

T416BH

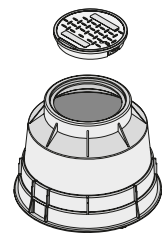

T416C

Part No.	Diameter at grade (in)	Outside Diameter (in)	Depth (in)	Cover Weight (lbs)	Weight of Box Base with Inserts (lbs)
T416B	9.125	13	10.25	1.5	3
Stainless steel lock bolt (3/8" – 16 x 1-3/4"); boxes and covers nest in 3.25" increments; 2 knockouts per box (3.5" x 1.5"); color: green					
T416BH	9.125	13	10.25	1.5	3
Includes 4 additional 1/2" bolts on cover. Stainless steel lock bolt (3/8" – 16 x 1-3/4"); boxes and covers nest in 3.25" increments; 2 knockouts per box (3.5" x 1.5"); color: green					
T416C	11	24.5	18.25	4.2	13.4
Pipe slot (2 places); color: black T416CKEY: Key for T416C Inspection Well					

nVent ERICO Cadweld Lightning Protection Molds



Cadweld Lightning Protection Molds

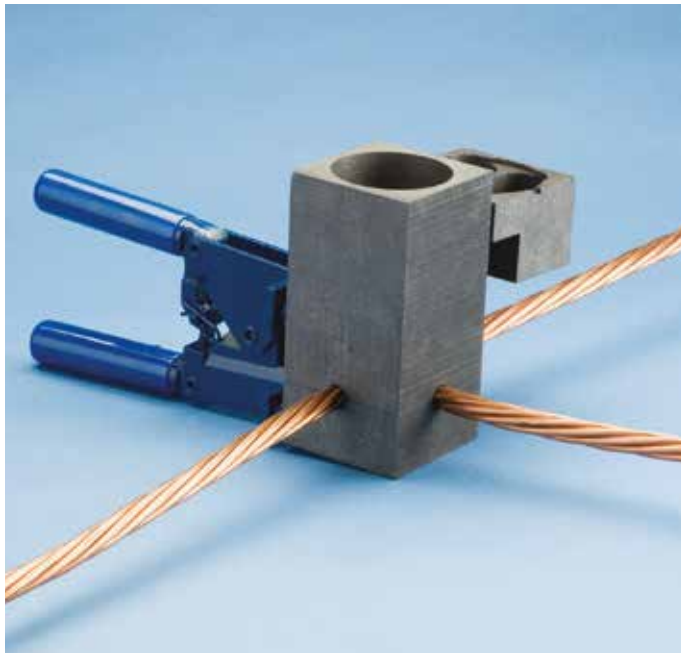

CADWELD LIGHTNING PROTECTION MOLDS

Cadweld lightning protection molds create a permanent molecular bond that will not loosen or corrode over time, and the connection provides a current carrying (fusing) capacity equal to that of the conductor. No external power source or heat is required for use, and the connections can be easily checked for quality by visual inspection.

No special skills are required for use with Cadweld lightning protection molds, which helps to keep labor costs low. They are made with lightweight and portable equipment and can be used with either Cadweld or Cadweld Plus welding material.

The Cadweld Mold Numbering System

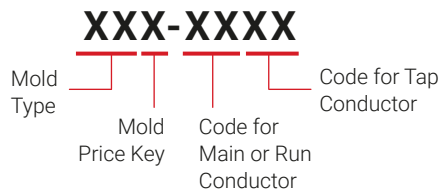

Examples

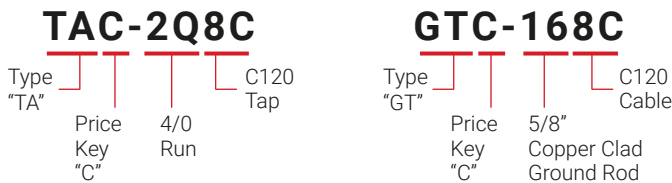

Cadweld Codes*

16	5/8" Copper-bonded Ground Rod
18	3/4" Copper-bonded Ground Rod
8C	LPC120, LPC121, LPC122 Lightning Conductor
8D	LPC125, LPC126R, LPC128, LPC401 Lightning Conductor
8F	LPC123, LPC127 Lightning Conductor
8G	LPC124 Lightning Conductor
2L	3/0 Concentric Stranded, LPC136
2Q	4/0 Concentric Stranded, LPC137, LPC404
1V	#2 Concentric Stranded

*For other cable sizes, please contact nVent or visit nVent.com/ERICO.

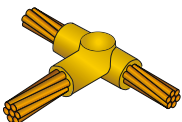
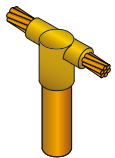
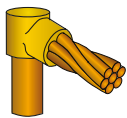

Mold Part No. *	Cadweld Welding Material Part Number	Cadweld Plus Part Number
GRC168C	115	115PLUSF20
GRC188C	115	115PLUSF20
GRC188G	115	115PLUSF20
GTC168C	150	150PLUSF20
GTC168D	150	150PLUSF20
GTC188C	150	150PLUSF20
GTC188D	150	150PLUSF20
GTC188G	200	200PLUSF20
TAC2Q8C	115	115PLUSF20
TAC2Q8D	115	115PLUSF20
TAC2Q8G	150	150PLUSF20
TAC8C8C	115	115PLUSF20
TAC8D8C	115	115PLUSF20
TAC8D8D	115	115PLUSF20
TAC8G8G	150	150PLUSF20

* For additional mold options contact nVent ERICO or visit nVent.com/ERICO.

Cadweld Lightning Protection Molds



GY

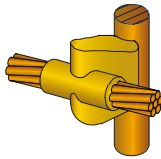

SS

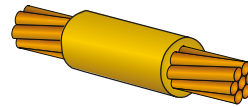

Mold Part No.	Cadweld Welding Material Part Number	Cadweld Plus Part Number
GYE188C	150	150PLUSF20
GYE188D	150	150PLUSF20

Mold Part No.	Cadweld Welding Material Part Number	Cadweld Plus Part Number
SSC8C	65	65PLUSF20
SSC8D	90	90PLUSF20

LA

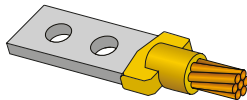

VF

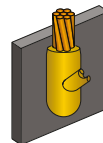

Mold Part No.	Cadweld Welding Material Part Number	Cadweld Plus Part Number
LAC8G001	150	150PLUSF20

Mold Part No.	Cadweld Welding Material Part Number	Cadweld Plus Part Number
VFC8C	115	115PLUSF20

PT

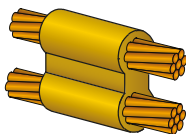

VS

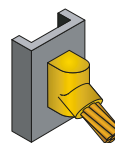

Mold Part No.	Cadweld Welding Material Part Number	Cadweld Plus Part Number
PTC2Q8C	150	150PLUSF20
PTC8C1V	115	115PLUSF20
PTC8C8C	150	150PLUSF20
PTC8D8D	200	200PLUSF20

Mold Part No.	Cadweld Welding Material Part Number	Cadweld Plus Part Number
VSC8C	90	90PLUSF20
VSC8D	115	115PLUSF20

Cadweld Lightning Protection Molds



Accessories



XLL160
Handle Clamps
(Excludes T320)



T111
Surefire™
Torch Head



T321
Rasp



T320
Flint Ignitor



T313
Card
Cleaning
Brush



T394
Mold
Cleaning
Brush



PLUSCU
CADWELD PLUS
Control Unit



T314
Cable
Cleaning
Brush



T403
Mold
Sealer

Cable Fasteners & Accessories

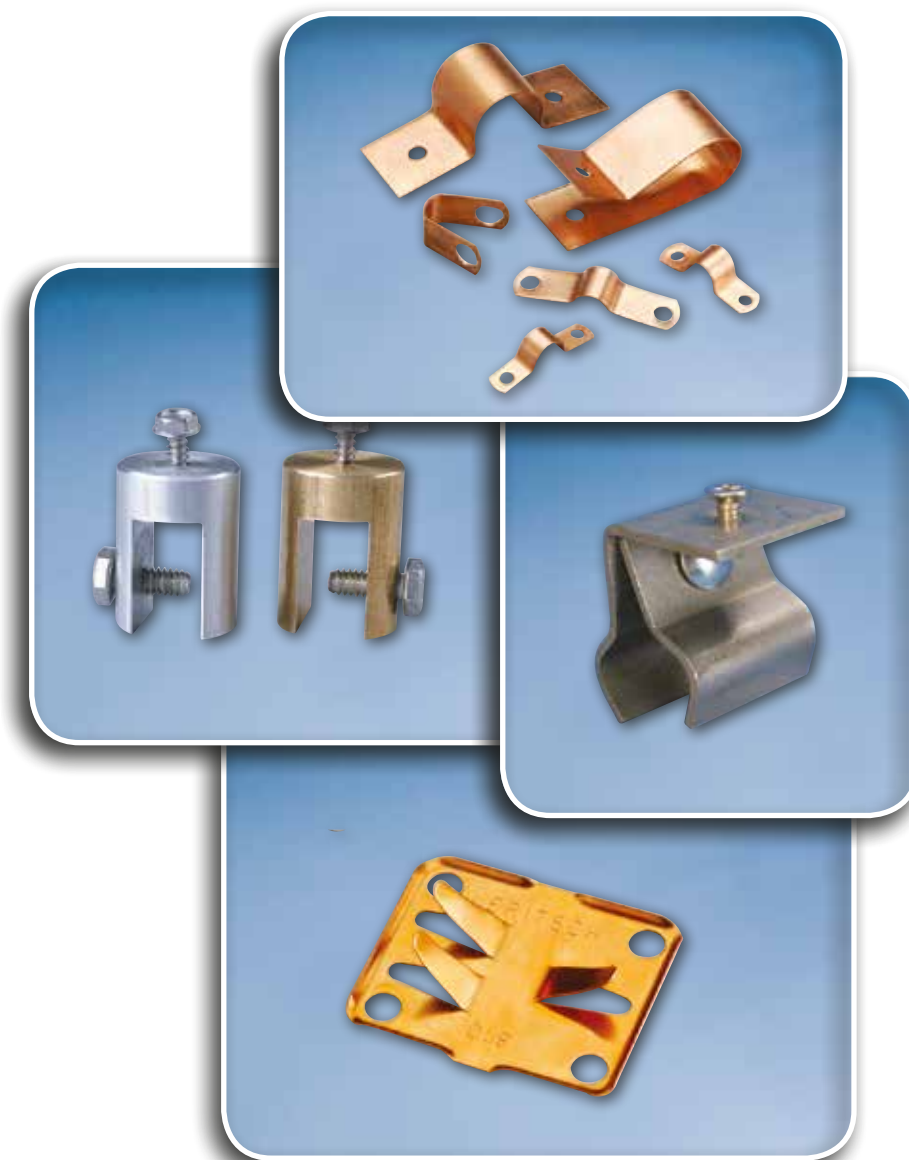

Cable Fasteners & Accessories



Fasteners

For the majority of lightning applications, conductors are required to be fastened to the structure every three feet. Fasteners can be connected to the structure with mechanical hardware or adhesive. Both mechanical and finger-type connections are permitted.



COPPER & ALUMINUM CABLE/CONDUIT STRAPS

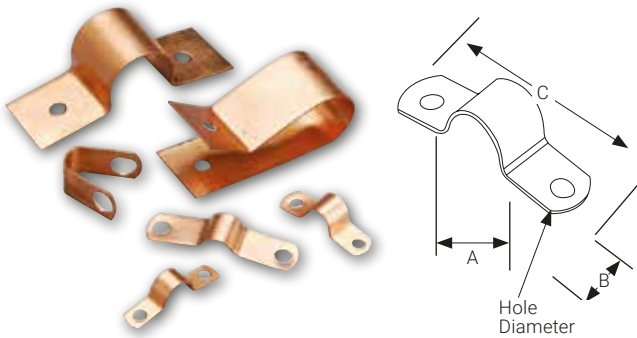

Cable straps are designed to secure lightning protection conductors and prevent displacement. They are mechanically secured with screws or nails and typically installed every 3 feet of conductor.

Part No.	Material	A (in)	B (in)	C (in)	Connection	Hole Diameter (in)
LPC801	Copper	-	3/8	-	One hole	3/16
LPC802	Copper	15/32	3/8	1.65	Two hole	3/16
LPA803	Aluminum	-	1/2	-	One hole	3/16
LPC803	Copper	-	1/2	-	One hole	3/16
LPA804	Aluminum	15/32	1/2	1.65	Two hole	3/16
LPC804	Copper	15/32	1/2	1.65	Two hole	3/16
LPA805	Aluminum	-	1/2	-	One hole	9/32
LPC805	Copper	-	1/2	-	One hole	9/32
LPC805L	Tinned Copper	-	1/2	-	One hole	9/32
LPA806	Aluminum	1/2	1/2	2.11	Two hole	9/32
LPC806	Copper	1/2	1/2	2.11	Two hole	9/32
LPA807	Aluminum	-	1-1/4	-	One hole	9/32
LPC807	Copper	-	1-1/4	-	One hole	9/32
LPA808	Aluminum	1.03	1-1/4	3.94	Two hole	9/32
LPC808	Copper	1.03	1-1/4	3.94	Two hole	9/32

CABLE HOLDERS



Flat cable holder for use with hot pitch, roofing compound or commercial adhesive on built-up roof surfaces or other location where penetration cannot be made. For use with all sizes of conductor.

Part No.	Material	Connection Type
LPA809	Aluminum	Mechanical
LPC809	Copper	Mechanical
LPC809L	Tinned Copper	Mechanical
LPA810	Aluminum	Crimp
LPC810	Copper	Crimp
LPC810L	Tinned Copper	Crimp

Cable Fasteners & Accessories

STANDING-SEAM CLAMPS - SERIES 814

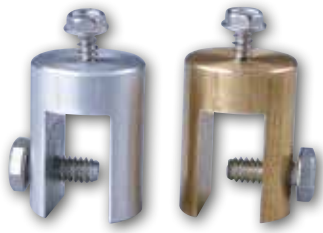

Brass or aluminum cable holder for standing seam roofing systems. Bottom groove machined .563" wide and 1" deep to secure on seam with 1/2"-20 screw. For use with 805 single hole series of straps for securing conductors.

Part No.	Material
LPA814	Aluminum
LPC814	Copper

SERIES 815



Stainless steel cable holder for standing seam roofing systems. Groove is variable up to 1" wide for rectangular seams or beams, also suitable mounting to seams with rounded or boxed ridge up to 1-1/2" wide. Cable fastener adjusts for either parallel or perpendicular cable runs. For use with 805 single hole straps for securing conductors.

Part No.	Material
LPS815	Stainless Steel

TREE SPIKES



LPC823 heavy duty bronze cast tree drive anchor for main or miniature cable. Drive anchor, then pinch cable holder.

ADHESIVE



M-1 is a high performance, solvent free, UV resistant, moisture curing polyether (tri-polymer). It is a multi-purpose structural sealant designed for difficult bonding and sealing applications. It is ideal for installations on EPDM, TPO and PVC membranes. It bonds aggressively to EPDM, PVC, BUR, coal tar, SBS modified bitumen, granulated APP, asphalt shingles, many types of coated metal, metal flashing details.

Part	Size (Oz.)	Color
LPP899BK	10.1	Black
LPP899GY	10.1	Grey
LPP899WH	10.1	White
LPP899WH28	30	White

A single 10 oz tube will adhere roughly 12 air terminal bases or 25 cable holders.

MISCELLANEOUS FASTENERS & ACCESSORIES



Part No.	Description
A928Q001	1/4"-20 x 5/8" Rubber Expansion Anchor
A931A002	.14" x 1-1/2" 4D Stainless Steel Slating Nail
A931A006	.14" x 2-1/2" 8D Stainless Steel Slating Nail
A927P020	#10 x 1-1/2" Stainless Steel Wood Screw
A927P023	#10 x 5/8" Hex Pan head Stainless Steel self-tapping screw
A927P024	#10 x 1" Hex Pan head Stainless Steel self-tapping screw
LPG848	Galvanized steel toggle bolt, 1/2" x 3"

Cable Fasteners & Accessories

EXPANSION ANCHORS



A930W004



A930W009



A930W011

Part No.	Drill Hole Diameter (in)	Drill Hole Depth (in)	Description
A930W004	1/4	1-1/4	Drive-in anchor with stainless steel nail, 1/4" x 1-1/4"
A930W009	7/8	1-3/4	Expansion shield anchor for use with 1-1/2" "LG" stud products
A930W011	5/8	2	Steel Drop-in anchor

STAINLESS STEEL HEX HEAD BOLTS



Length (in)	1/4"-20	5/16"-18	3/8"-16	1/2"-13
1/2	A927F177	-	-	-
3/4	A927F179	A927F187	A927F193	-
1	A927F181	A927F189	A927F195	A927F199
1-1/4	A927F183	A927F236	-	-
1-1/2	A927F185	A927F191	A927F197	A927F201
2	-	-	-	A927F203

STAINLESS STEEL SPLIT LOCK-WASHERS



Size (in)	Flat	Split Lock
1/4	A929A095	A929B038
5/16	A929A097	A929B024
3/8	A929A099	A929B025
1/2	A929A101	A929B026
5/8	A929A103	A929B036
3/4	A929A105	A929B040

STAINLESS STEEL HEX HEAD NUTS

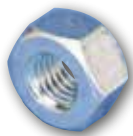

Size (in)	Stainless
1/4-20	A928K011
5/16-18	A928K017
3/8-16	A928K019
1/2-13	A928K021
5/8-11	A928K023
3/4-10	A928K025

NEOPRENE SEALING WASHERS



Size (in)	Neoprene
#10 Screw	A929H001
1/4 Bolt	A929H002
5/16 Bolt	A929H003
3/8 Bolt	A929H004
1/2 Bolt	A929H005
5/8 Bolt	A929H006

POLYVINYLCHLORIDE PROTECTOR (LPP743)



Polyvinylchloride protector for cables through 5/8" diameter. For use where stranded cables are subject to displacement or damage. Protector 1" O.D. PVC Pipe, 10' long. Secure with Part No. LPC807 or LPC808 fasteners.

GALVANIZED SHEET STEEL PROTECTOR (LPP745)



Galvanized sheet steel protector for cables through 3/4" diameter. For use where stranded cables are subject to displacement or damage. Provided with 4 single hole clips.

PVC PROTECTOR

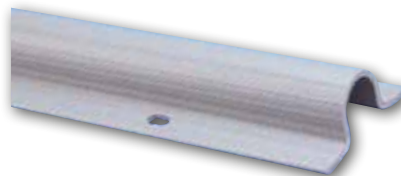

PVC protector for cables of all sizes up to 1" or 2". For use where stranded cables are subject to displacement or damage. Two sizes available in 8' lengths. Each section able to overlap for longer lengths.

Part No.	Dimensions
LPP74718	1" x 8'
LPP74728	2" x 8'

Index

Part Number	Page
611300	47
611380	47
613400	47
613480	47
615800	47
615880	47
631300	47
631380	47
633400	47
633480	47
635800	47
635880	47
A927F177	56
A927F179	56
A927F181	56
A927F183	56
A927F185	56
A927F187	56
A927F189	56
A927F191	56
A927F193	56
A927F195	56
A927F197	56
A927F199	56
A927F201	56
A927F203	56
A927P020	55
A927P023	55
A927P024	55
A928K011	56
A928K017	56
A928K019	56
A928K021	56
A928K023	56
A928K025	56
A928Q001	55
A929A095	56
A929A097	56
A929A099	56
A929A101	56
A929A103	56
A929A105	56
A929B024	56
A929B025	56

Part Number	Page
A929B026	56
A929B036	56
A929B038	56
A929B040	56
A929H001	56
A929H002	56
A929H003	56
A929H004	56
A929H005	56
A929H006	56
A930W004	56
A930W009	56
A930W011	56
A931A002	55
A931A006	55
CC12F	48
CC34	48
CC58	48
CR100	48
CR12S	48
CR34	48
CR58	48
GRC168C	50
GRC188C	50
GRC188G	50
GTC168C	50
GTC168D	50
GTC188C	50
GTC188D	50
GTC188G	50
GYE188C	51
GYE188D	51
LAC8G001	51
LPA100	14
LPA101	14
LPA102	14
LPA105	14
LPA140	16
LPA141	16
LPA221	18
LPA221ST	18
LPA222	18
LPA222ST	18
LPA223	18

Part Number	Page
LPA223ST	18
LPA224	18
LPA224ST	18
LPA225	18
LPA225ST	18
LPA226	18
LPA226ST	18
LPA227	18
LPA227ST	18
LPA228	18
LPA228ST	18
LPA241	18
LPA241ST	18
LPA242	18
LPA242ST	18
LPA243	18
LPA243ST	18
LPA244	18
LPA244MST	18
LPA244ST	18
LPA245	18
LPA245ST	18
LPA246	18
LPA246ST	18
LPA247	18
LPA247MST	18
LPA247ST	18
LPA248	18
LPA248ST	18
LPA252	19
LPA254	19
LPA255	19
LPA262	19
LPA264	19
LPA265	19
LPA272CTO	19
LPA273CTO	19
LPA27512	19
LPA27558	19
LPA27812	20
LPA27858	20
LPA29612	20
LPA29658	20
LPA30212	22

Index

Part Number	Page
LPA30258	22
LPA30412	22
LPA30458	22
LPA30512	22
LPA30558H	22
LPA30558V	22
LPA30912	23
LPA30958	23
LPA31212	23
LPA31258	23
LPA31512	23
LPA31558	23
LPA31812	23
LPA31858	23
LPA31912	24
LPA31958	24
LPA32112	24
LPA32158	24
LPA330	24
LPA331	24
LPA33912	24
LPA33958	24
LPA34012	24
LPA34058	24
LPA34512	24
LPA34558	24
LPA34712	25
LPA34758	25
LPA34812	25
LPA34858	25
LPA37112	25
LPA37158	25
LPA37212	26
LPA37258	26
LPA501	34
LPA502	34
LPA503	34
LPA505	34
LPA508	34
LPA510	34
LPA513	34
LPA516	35
LPA517	35
LPA527	35

Part Number	Page
LPA528	35
LPA532	35
LPA533	35
LPA535	35
LPA536	35
LPA537	35
LPA540	35
LPA55112	36
LPA55138	36
LPA55312	36
LPA55314	36
LPA55338	36
LPA554	36
LPA555	36
LPA557	36
LPA559	36
LPA570	37
LPA571	37
LPA580	37
LPA588	38
LPA590	38
LPA595	38
LPA595L	38
LPA5962	37
LPA5963	37
LPA5964	37
LPA5966	37
LPA598	38
LPA61012	40
LPA61058	40
LPA619	40
LPA620	40
LPA621	40
LPA622	40
LPA62412	41
LPA62458	41
LPA62612	41
LPA62658	41
LPA62812	41
LPA62858	41
LPA664	41
LPA66418	41
LPA66424	41
LPA669	26

Part Number	Page
LPA670	26
LPA671	26
LPA672	26
LPA673	26
LPA674	26
LPA675	26
LPA676	26
LPA677	26
LPA678	26
LPA803	54
LPA804	54
LPA805	54
LPA806	54
LPA807	54
LPA808	54
LPA809	54
LPA810	54
LPA814	55
LPA858	36
LPC120	15
LPC120L	15
LPC122	15
LPC122L	15
LPC123	15
LPC124	15
LPC124L	15
LPC125	15
LPC126R	15
LPC126RL	15
LPC127	15
LPC127L	15
LPC128	15
LPC136	15
LPC137	15
LPC137L	15
LPC150	16
LPC151	16
LPC154	16
LPC154L	16
LPC201B	18
LPC201BST	18
LPC202	18
LPC202B	18
LPC202BST	18

Index

Part Number	Page
LPC202LST	18
LPC202ST	18
LPC203	18
LPC203B	18
LPC203BST	18
LPC203LST	18
LPC203ST	18
LPC204	18
LPC204B	18
LPC204BST	18
LPC204LST	18
LPC204ST	18
LPC205	18
LPC205B	18
LPC205BST	18
LPC205LST	18
LPC205ST	18
LPC206	18
LPC206B	18
LPC206BST	18
LPC206LST	18
LPC206ST	18
LPC207	18
LPC207B	18
LPC207BST	18
LPC207LST	18
LPC207ST	18
LPC208	18
LPC208B	18
LPC208BST	18
LPC208LST	18
LPC208ST	18
LPC221B	18
LPC221BST	18
LPC222	18
LPC222B	18
LPC222BST	18
LPC222LST	18
LPC222ST	18
LPC223	18
LPC223B	18
LPC223BST	18
LPC223LST	18
LPC223ST	18

Part Number	Page
LPC224	18
LPC224B	18
LPC224BST	18
LPC224LST	18
LPC224ST	18
LPC225	18
LPC225B	18
LPC225BST	18
LPC225LST	18
LPC225ST	18
LPC226	18
LPC226B	18
LPC226BST	18
LPC226LST	18
LPC226ST	18
LPC227	18
LPC227B	18
LPC227BST	18
LPC227LST	18
LPC227ST	18
LPC228	18
LPC228B	18
LPC228BST	18
LPC228LST	18
LPC228ST	18
LPC241B	18
LPC241BST	18
LPC242	18
LPC242B	18
LPC242BST	18
LPC242LST	18
LPC242ST	18
LPC243	18
LPC243B	18
LPC243BST	18
LPC243LST	18
LPC243ST	18
LPC244	18
LPC244B	18
LPC244BST	18
LPC244LST	18
LPC244MBST	18
LPC244ST	18
LPC245	18

Part Number	Page
LPC245B	18
LPC245BST	18
LPC245LST	18
LPC245ST	18
LPC246	18
LPC246B	18
LPC246BST	18
LPC246LST	18
LPC246ST	18
LPC247	18
LPC247B	18
LPC247BST	18
LPC247LST	18
LPC247MBST	18
LPC247ST	18
LPC248	18
LPC248B	18
LPC248BST	18
LPC248LST	18
LPC248ST	18
LPC252	19
LPC254	19
LPC255	19
LPC262	19
LPC264	19
LPC265	19
LPC271CTO	19
LPC272CTO	19
LPC273CTO	19
LPC27512	19
LPC27558	19
LPC27812	20
LPC27838	20
LPC27858	20
LPC29612	20
LPC29638	20
LPC29658	20
LPC30212	22
LPC30238	22
LPC30258	22
LPC302L12	22
LPC302L38	22
LPC302L58	22
LPC30412	22

Index

Part Number	Page
LPC30438	22
LPC30458	22
LPC30512	22
LPC30538	22
LPC30558H	22
LPC30558V	22
LPC305L12	22
LPC305L38	22
LPC305L58H	22
LPC305L58V	22
LPC30912	23
LPC30938	23
LPC30958	23
LPC31212	23
LPC31238	23
LPC31258	23
LPC31512	23
LPC31538	23
LPC31558	23
LPC31812	23
LPC31838	23
LPC31858	23
LPC31912	24
LPC31938	24
LPC31958	24
LPC32112	24
LPC32138	24
LPC32158	24
LPC330	24
LPC330L	24
LPC331	24
LPC331L	24
LPC33912	24
LPC33938	24
LPC33958	24
LPC34012	24
LPC34038	24
LPC34058	24
LPC34512	24
LPC34538	24
LPC34558	24
LPC34712	25
LPC34738	25
LPC34758	25

Part Number	Page
LPC34812	25
LPC34838	25
LPC34858	25
LPC37112	25
LPC37138	25
LPC37158	25
LPC371L12	25
LPC371L38	25
LPC371L58	25
LPC37212	26
LPC37238	26
LPC37258	26
LPC372L12	26
LPC372L38	26
LPC372L58	26
LPC401	30
LPC404	30
LPC401CTO	28
LPC404CTO	28
LPC415	28
LPC416	28
LPC417	28
LPC418	28
LPC421	28
LPC422	28
LPC423	28
LPC424	28
LPC425	28
LPC426	28
LPC427	28
LPC428	28
LPC431	29
LPC433	29
LPC435LG	29
LPC435SH	29
LPC436LG	29
LPC436SH	29
LPC437LG	29
LPC437SH	29
LPC441	30
LPC443	30
LPC446	30
LPC448	30
LPC451	30

Part Number	Page
LPC456	30
LPC464	30
LPC465	30
LPC466	30
LPC467	30
LPC4670X1	30
LPC4670X2	30
LPC467X1	30
LPC467X2	30
LPC468	31
LPC475	31
LPC477	31
LPC478	31
LPC48034LG	31
LPC48034SH	31
LPC48058LG	31
LPC48058SH	31
LPC481LG	31
LPC481SH	31
LPC482LG	32
LPC482SH	32
LPC483	32
LPC48412	32
LPC49234	32
LPC49258	32
LPC501	34
LPC502	34
LPC502A	34
LPC502L	34
LPC503	34
LPC505	34
LPC508L	34
LPC510	34
LPC510L	34
LPC513	34
LPC513L	34
LPC516	35
LPC516A	35
LPC517	35
LPC517L	35
LPC527	35
LPC528	35
LPC532	35
LPC532L	35

Index

Part Number	Page
LPC533	35
LPC533L	35
LPC535	35
LPC535L	35
LPC536	35
LPC537	35
LPC537L	35
LPC540	35
LPC540A	35
LPC540L	35
LPC55112	36
LPC55138	36
LPC551L12	36
LPC551L38	36
LPC55312	36
LPC55314	36
LPC55338	36
LPC553L12	36
LPC553L14	36
LPC553L38	36
LPC554	36
LPC554L	36
LPC555	36
LPC555L	36
LPC557	36
LPC557L	36
LPC559	36
LPC559L	36
LPC570	37
LPC570L	37
LPC571	37
LPC571L	37
LPC580	37
LPC580L	37
LPC588	38
LPC590	38
LPC595	38
LPC5962	37
LPC5963	37
LPC5964	37
LPC5966	37
LPC61012	40
LPC61038	40
LPC61058	40

Part Number	Page
LPC610BI12	40
LPC610BI38	40
LPC610BI58	40
LPC619	40
LPC619A	40
LPC620	40
LPC620A	40
LPC621	40
LPC621A	40
LPC622	40
LPC622A	40
LPC62412	41
LPC62438	41
LPC62458	41
LPC624A12	41
LPC624A58	41
LPC62612	41
LPC62638	41
LPC62658	41
LPC626A12	41
LPC626A58	41
LPC62812	41
LPC62838	41
LPC62858	41
LPC628A12	41
LPC628A58	41
LPC664	41
LPC66418	41
LPC66424	41
LPC664A	41
LPC664A18	41
LPC664A24	41
LPC664BI	41
LPC664L	41
LPC66518	41
LPC66518NC	41
LPC66518NCBI	41
LPC66518BI	41
LPC66524	41
LPC66524BI	41
LPC66524NC	41
LPC66524NCBI	41
LPC669	26
LPC670	26

Part Number	Page
LPC671	26
LPC672	26
LPC673	26
LPC674	26
LPC675	26
LPC676	26
LPC677	26
LPC678	26
LPC680	44
LPC681	44
LPC682	44
LPC700	47
LPC702	47
LPC704	47
LPC706	47
LPC711	47
LPC750	45
LPC751	45
LPC752	45
LPC753	45
LPC754	45
LPC755	45
LPC790	45
LPC795	45
LPC801	54
LPC802	54
LPC803	54
LPC804	54
LPC805	54
LPC805L	54
LPC806	54
LPC807	54
LPC808	54
LPC809	54
LPC809L	54
LPC810	54
LPC810L	54
LPC814	55
LPC823	55
LPC858	36
LPC858L	36
LPC3410NC4	20
LPC346NC4	20
LPC348NC4	20

Index

Part Number	Page
LPC5810NC4	20
LPC584NC4	20
LPC585NC4	20
LPC586NC4	20
LPC588NC4	20
LPG35058	25
LPG35158	25
LPG35258	25
LPG35358	25
LPG35458	25
LPG36058	25
LPG36158	25
LPG36258	25
LPG36358	25
LPG36458	25
LPG848	55
LPLC401CTO	28
LPLC404CTO	28
LPLC411	29
LPLC412	29
LPLC413	29
LPLC414	29
LPLC415	29
LPLC416	29
LPLC417	29
LPLC418	29
LPLC421	29
LPLC422	29
LPLC423	29
LPLC424	29
LPLC425	29
LPLC426	29
LPLC427	29
LPLC428	29
LPLC431	29
LPLC433	29
LPLC435LG	29
LPLC435SH	29
LPLC436LG	29
LPLC436SH	29
LPLC437LG	29
LPLC437SH	29
LPLC441	30
LPLC443	30

Part Number	Page
LPLC446	30
LPLC448	30
LPLC451	30
LPLC464	30
LPLC465	30
LPLC468	31
LPLC48034LG	31
LPLC48034SH	31
LPLC48058LG	31
LPLC48058SH	31
LPLC481LG	31
LPLC481SH	31
LPLC482LG	32
LPLC482SH	32
LPLC49234	32
LPLC49258	32
LPP667	44
LPP691	44
LPP692	44
LPP693	44
LPP743	42, 56
LPP745	42, 56
LPP74718	42, 56
LPP74728	42, 56
LPP899BK	55
LPP899GY	55
LPP899WH	55
LPP899WH28	55
LPS272CTO	19
LPS273CTO	19
LPS411	29
LPS412	29
LPS413	29
LPS414	29
LPS415	29
LPS416	29
LPS417	29
LPS418	29
LPS421	29
LPS422	29
LPS423	29
LPS424	29
LPS425	29
LPS426	29

Part Number	Page
LPS427	29
LPS428	29
LPS451	30
LPS456	30
LPS469	31
LPS661CTO	41
LPS66218	41
LPS66212	41
LPS662CTO	41
LPS663CTO	41
LPS815	55
PC318L12	23
PC318L38	23
PC318L58	23
PLUSCU	52
PTC2Q8C	51
PTC8C1V	51
PTC8C8C	51
PTC8D8D	51
SSC8C	51
SSC8D	51
T111	52
T313	52
T314	52
T320	52
T321	52
T394	52
T403	52
T416B	48
T416BH	48
T416C	48
TAC2Q8C	50
TAC2Q8D	50
TAC2Q8G	50
TAC8C8C	50
TAC8D8C	50
TAC8D8D	50
TAC8G8G	50
VFC8C	51
VSC8C	51
VSC8D	51
XLL160	52

Our powerful portfolio of brands:

CADDY ERICO HOFFMAN RAYCHEM SCHROFF TRACER



[nVent.com/ERICO](https://www.nvent.com/ERICO)

WARNING: nVent products shall be installed and used only as indicated in nVent's product instruction sheets and training materials. Instruction sheets are available at [nVent.com/ERICO](https://www.nvent.com/ERICO) and from your nVent customer service representative. Improper installation, misuse, misapplication or other failure to completely follow nVent's instructions and warnings may cause product malfunction, property damage, serious bodily injury and/or death, and void your warranty.

©2018 nVent. All nVent marks and logos are owned or licensed by nVent Services GmbH or its affiliates. All other trademarks are the property of their respective owners. nVent reserves the right to change specifications without notice.

ERICO-CAT-E1147C-E216CT12WWEN-EN-1805