

Introduction

Cadweld was the first exothermic connection to the market, patented in 1938. Cadweld Plus was introduced in 2003 with the first electronic ignition for exothermic welding. This guide provides a quick overview to often-used molds, weld metal and accessories for both traditional nVent ERICO Cadweld and nVent ERICO Cadweld Plus ignition methods. For a more complete listing of nVent ERICO Cadweld products, please visit Cadweld.com.

nVent ERICO Cadweld Plus Welding Material consists of copper oxide and aluminum granular particles. Plus simplifies the method of making exothermic connections by packaging weld metal into an integrated cup, eliminating the need for starting material or a separate metal disk. With the nVent ERICO Cadweld Plus Impulse Exothermic Welding Control Unit, welds can be completed up to 4.5 meters away.

nVent ERICO Cadweld Welding Material also consists of copper oxide and aluminum granular particles and is packaged in a blue tube, with a fine copper oxide and aluminum material called starting material at the bottom of each plastic tube. Welding material is sold along with metal disks.

nVent ERICO Cadweld One Shot and nVent ERICO Cadweld Plus One Shot come in a convenient, single-use package to make a connection without a graphite mold. One Shot connections are range-taking for conductors and eliminate the need to preheat the graphite mold.

nVent ERICO Cadweld Exolon produces the same permanent bonds as traditional Cadweld or Cadweld Plus without smoke and other emissions. Exolon molds and welding material can be ordered by adding and XL prefix to the part number.

Please contact nVent or visit Cadweld.com for more information.



TABLE OF CONTENTS

Cable to Cable.....	3
TA – Horizontal Tee	3
PT – Parallel Horizontal Tee	3
SS – Horizontal Splice.....	3
XB – Lapped Horizontal Splice.....	3
Busbar to Busbar	4
BA – Horizontal busbar connection, on edge	4
BB - Horizontal busbar connection, on flat way.....	4
BM - Tee busbar connection, on flat way	4
Cable to Earth Rod	5-6
GR – Cable to Ground Rod.....	5
GR One Shot – Cable to Ground Rod	5
GT – Through Cable to Top of Earth Rod.....	5
GT One Shot – Cable to Ground Rod	5
GY – Through Cable to Side of Earth Rod.....	6
Lug or Busbar to Earth Rod.....	6
CN – Elbow bar on flat way	6
Cable to Lug or Busbar	6
LJ - Cable to Busbar	6
LE - Horizontal Cable to Flat Busbar or Lug.....	6
Cable to Steel Surface.....	7
VS – Cable to Vertical Steel	7
VB – Cable to Vertical Steel	7
HA – Cable to Horizontal Steel.....	7
HS – Cable to Horizontal Steel.....	7
Cable to Rebar	8
RR – Cable to Rebar	8
RT – Cable to Rebar.....	8
RC – Cable to Rebar	8
Materials, Tools & Accessories.....	9
nVent ERICO Cadweld Molds	10-11

Cable to Cable

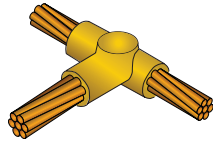

TA – HORIZONTAL TEE

Conductor Size		Mold	Traditional Welding Material	Cadweld Plus Welding Material
Run (mm ²)	Tap (mm ²)			
25	25	TACY1Y1	32	32PLUSF20
35	35	TACY2Y2	45	45PLUSF20
50	50	TACY3Y3	90	90PLUSF20
70	70	TACY4Y4	90	90PLUSF20
95	95	TACY5Y5	115	115PLUSF20
120	120	TACY6Y6	150	150PLUSF20
150	150	TACY7Y7	200	200PLUSF20
185	185	TACY8Y8	200	200PLUSF20

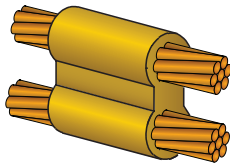

PT – PARALLEL HORIZONTAL TEE

Pro tip: The PT connection is the most versatile mold in the Cadweld line. Mold can be used to make a parallel through or a splice or a "T" or "X" by bending cable.

Conductor Size		Mold	Traditional Welding Material	Cadweld Plus Welding Material
Run (mm ²)	Tap (mm ²)			
25	25	PTCY1Y1	45	45PLUSF20
35	35	PTCY2Y2	65	65PLUSF20
50	50	PTCY3Y3	90	90PLUSF20
70	70	PTCY4Y4	115	115PLUSF20
95	95	PTCY5Y5	200	200PLUSF20
120	120	PTCY6Y6	250	250PLUSF20
150	150	PTCY7Y7	150 (2)	300PLUSF20
185	185	PTCY8Y8	150 (2)	300PLUSF20

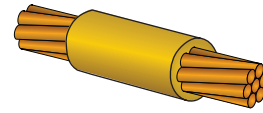

SS – HORIZONTAL SPLICE

Conductor Size (mm ²)	Mold	Traditional Welding Material	Cadweld Plus Welding Material
25	SSCY1	32	32PLUSF20
35	SSCY2	32	32PLUSF20
50	SSCY3	45	45PLUSF20
70	SSCY4	65	65PLUSF20
95	SSCY5	90	90PLUSF20
120	SSCY6	115	115PLUSF20
150	SSCY7	115	115PLUSF20
185	SSCY8	150	150PLUSF20

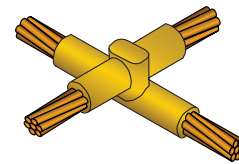

XB – LAPPED HORIZONTAL SPLICE

Conductor Size		Mold	Traditional Welding Material	Cadweld Plus Welding Material
Run (mm ²)	Tap (mm ²)			
25	25	XBCY1Y1	65	65PLUSF20
35	35	XBCY2Y2	90	90PLUSF20
50	50	XBCY3Y3	115	115PLUSF20
70	70	XBQY4Y4	200	200PLUSF20
95	95	XBQY5Y5	250	250PLUSF20
120	120	XBQY6Y6	150 (2)	300PLUSF20
150	150	XBZY7Y7	200 (2)	400PLUSF20
185	185	XBZY8Y8	500	500PLUSF20

Handle Clamp / Frame (See Page 10)

Price Key*	Notes
C	REQUIRES L160 HANDLE CLAMP
Q	REQUIRES L160 HANDLE CLAMP
Z	REQUIRES L159 HANDLE CLAMP

*Price key is usually the third letter or digit in the mold part number.

Busbar to Busbar

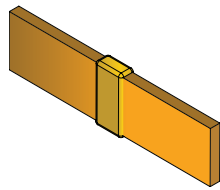

BA - HORIZONTAL BUSBAR CONNECTION, ON EDGE

Conductor Size		Mold	Traditional Welding Material	Cadweld Plus Welding Material
Run (mm)	Tap (mm)			
3 x 25	3 x 25	BACCAJ	65	65PLUSF20
4 x 25	4 x 25	BACEAJ	90	90PLUSF20
2 x 30	2 x 30	BACBAK	65	65PLUSF20
3 x 30	3 x 30	BACCAK	90	90PLUSF20
4 x 30	4 x 30	BACEAK	115	115PLUSF20
5 x 30	5 x 30	BACFAK	115	115PLUSF20
3 x 40	3 x 40	BACCAL	115	115PLUSF20
4 x 40	4 x 40	BACEAL	150	150PLUSF20
5 x 40	5 x 40	BACFAL	150	150PLUSF20
6 x 40	6 x 40	BACPAL	150	150PLUSF20
6 x 50	6 x 50	BACPAM	200	200PLUSF20

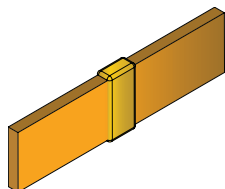

BB - HORIZONTAL BUSBAR CONNECTION, ON FLAT WAY

Conductor Size		Mold	Traditional Welding Material	Cadweld Plus Welding Material
Run (mm)	Tap (mm)			
3 x 25	3 x 25	BBCCAJ	90	90PLUSF20
4 x 25	4 x 25	BBCEAJ	90	90PLUSF20
5 x 25	5 x 25	BBCFAJ	115	115PLUSF20
2 x 30	2 x 30	BBCBAK	90	90PLUSF20
3 x 30	3 x 30	BBCCA K	115	115PLUSF20
4 x 30	4 x 30	BBCEAK	115	155PLUSF20
5 x 30	5 x 30	BBCFAK	115	115PLUSF20
3 x 40	3 x 40	BBCCAL	115	115PLUSF20
4 x 40	4 x 40	BBCEAL	150	150PLUSF20
5 x 40	5 x 40	BBCFAL	150	150PLUSF20
6 x 40	6 x 40	BBCPAL	150	150PLUSF20
6 x 50	6 x 50	BBDPAMPAM	250	250PLUSF20

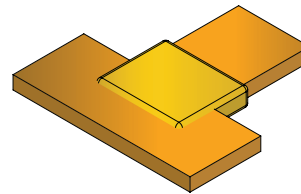

BM - TEE BUSBAR CONNECTION, ON FLAT WAY

Conductor Size		Mold	Traditional Welding Material	Cadweld Plus Welding Material
Run (mm)	Tap (mm)			
3 x 25	3 x 25	BMCCAJCAJ	90	90PLUSF20
4 x 25	4 x 25	BMCEAJEAJ	90	90PLUSF20
5 x 25	5 x 25	BMCFAJFAJ	115	115PLUSF20
2 x 30	2 x 30	BMCBAKBAK	90	90PLUSF20
3 x 30	3 x 30	BMCCA KCAK	90	90PLUSF20
4 x 40	4 x 30	BMCEAKEAK	90	90PLUSF20
5 x 30	5 x 30	BMCFAKFAK	115	115PLUSF20
3 x 40	3 x 40	BMCCALCAL	90	90PLUSF20
4 x 40	4 x 40	BMCEALEAL	150	150PLUSF20
5 x 40	5 x 40	BMCFALFAL	150	150PLUSF20
6 x 40	6 x 40	BMCPALPAL	150	150PLUSF20
5 x 50	5 x 50	BMDFAMFAM	250	250PLUSF20
6 x 50	6 x 50	BMDPAMPAM	250	250PLUSF20

Handle Clamp / Frame (See Page 10)	
Price Key*	Notes
C	REQUIRES L160 HANDLE CLAMP
D	REQUIRES L159 HANDLE CLAMP

*Price key is usually the third letter or digit in the mold part number.

Cable to Earth Rod

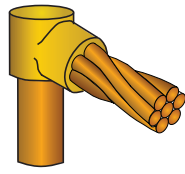

GR – CABLE TO GROUND ROD

Earth Rod Size	Conductor Size (mm ²)	Mold	Traditional Welding Material	Cadweld Plus Welding Material
14.3mm Copper-bonded Sectional (threaded) or Plain	25	GRC16Y1	65	65PLUSF20
	35	GRC16Y2	65	65PLUSF20
	50	GRC16Y3	90	90PLUSF20
	70	GRC16Y4	90	90PLUSF20
	95	GRC16Y5	90	90PLUSF20
	120	GRC16Y6	90	90PLUSF20
	150	GRC16Y7	115	115PLUSF20
	185	GRC16Y8	150	150PLUSF20
17.3mm Copper-bonded Sectional (threaded) or Plain	25	GRC18Y1	90	90PLUSF20
	35	GRC18Y2	90	90PLUSF20
	50	GRC18Y3	90	90PLUSF20
	70	GRC18Y4	90	90PLUSF20
	95	GRC18Y5	90	90PLUSF20
	120	GRC18Y6	90	90PLUSF20
	150	GRC18Y7	115	115PLUSF20
	185	GRC18Y8	150	150PLUSF20

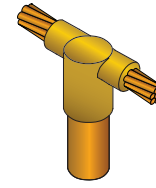

GT – THROUGH CABLE TO TOP OF EARTH ROD

Pro tip: A GT mold can also be used to make a GR connection by stopping the cable at the outside edge of the mold.

Earth Rod Size	Conductor Size (mm ²)	Mold	Traditional Welding Material	Cadweld Plus Welding Material
14.3mm Copper-bonded Sectional (threaded) or Plain	25	GTC16Y1	90	90PLUSF20
	35	GTC16Y2	90	90PLUSF20
	50	GTC16Y3	90	90PLUSF20
	70	GTC16Y4	115	115PLUSF20
	95	GTC16Y5	115	115PLUSF20
	120	GTC16Y6	150	150PLUSF20
	150	GTC16Y7	200	200PLUSF20
	185	GTC16Y8	200	200PLUSF20
17.3mm Copper-bonded Sectional (threaded) or Plain	25	GTC18Y1	90	90PLUSF20
	35	GTC18Y2	90	90PLUSF20
	50	GTC18Y3	90	90PLUSF20
	70	GTC18Y4	115	115PLUSF20
	95	GTC18Y5	115	115PLUSF20
	120	GTC18Y6	150	150PLUSF20
	150	GTC18Y7	200	200PLUSF20
	185	GTC18Y8	200	200PLUSF20

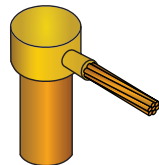

GR ONE SHOT – CABLE TO GROUND ROD

Earth Rod Size	Conductor Size (mm ²)	Cadweld One Shot P/N	Cadweld Plus One Shot P/N
14.3mm Copper-bonded Sectional (threaded) or Plain	25	GR1161L	GR1161LPLUS
	35	GR1161V	GR1161VPLUS
	50	GR1162C	GR1162CPLUS
	70	GR1162G	GR1162GPLUS
	95	GR1162Q	GR1162QPLUS
17.3mm Copper-bonded Sectional (threaded) or Plain	25	GR1181L	GR1181LPLUS
	35	GR1181V	GR1181VPLUS
	50	GR1182C	GR1182CPLUS
	70	GR1182G	GR1182GPLUS
	95	GR1182Q	GR1182QPLUS

Weld material included with One Shot. Sleeves not optional, must use the sleeves that come with the One Shot ordered.

Pro tip: nVent ERICO Cadweld One Shot comes in a convenient, single-use package to make a connection without a graphite mold. No need to preheat mold and the mold is range-taking for conductors.

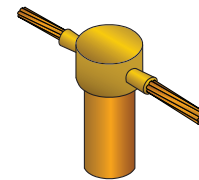

GT ONE SHOT – CABLE TO GROUND ROD

Earth Rod Size	Conductor Size (mm ²)	Cadweld One Shot P/N	Cadweld Plus One Shot P/N
14.3mm Copper-bonded Sectional (threaded) or Plain	25	GT1161L	GT1161LPLUS
	35	GT1161V	GT1161VPLUS
	50	GT1162C	GT1162CPLUS
	70	GT1162G	GT1162GPLUS
	95	GT1162Q	GT1162QPLUS
17.3mm Copper-bonded Sectional (threaded) or Plain	25	GT1181L	GT1181LPLUS
	35	GT1181V	GT1181VPLUS
	50	GT1182C	GT1182CPLUS
	70	GT1182G	GT1182GPLUS
	95	GT1182Q	GT1182QPLUS

Weld material included with One Shot. Sleeves not optional, must use the sleeves that come with the One Shot ordered.

Handle Clamp / Frame (See Page 10)

Price Key	Notes
C	REQUIRES L160 HANDLE CLAMP

Additional nVent ERICO Cadweld One Shot connections to ground rods available on Cadweld.com.

Cable to Earth Rod • Lug or Busbar to Earth Rod

• Cable to Lug or Busbar

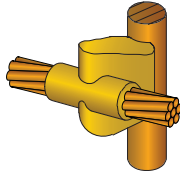

GY – THROUGH CABLE TO SIDE OF EARTH ROD

Pro tip: The GY connection allows you to make a connection and then finish driving the ground rod.

Earth Rod Size	Conductor Size (mm ²)	Mold	Traditional Welding Material	Cadweld Plus Welding Material
14.3mm Copper-bonded Sectional (threaded) or Plain	25	GYR16Y1	90	90PLUSF20
	35	GYR16Y2	90	90PLUSF20
	50	GYR16Y3	115	115PLUSF20
	70	GYR16Y4	115	115PLUSF20
	95	GYR16Y5	150	150PLUSF20
	120	GYR16Y6	150	150PLUSF20
	150	GYR16Y7	150	150PLUSF20
	185	GYR16Y8	250	250PLUSF20
17.3mm Copper-bonded Sectional (threaded) or Plain	25	GYR18Y1	90	90PLUSF20
	35	GYR18Y2	90	90PLUSF20
	50	GYR18Y3	115	115PLUSF20
	70	GYR18Y4	115	115PLUSF20
	95	GYR18Y5	150	150PLUSF20
	120	GYR18Y6	200	200PLUSF20
	150	GYR18Y7	250	250PLUSF20
	185	GYF18Y8	200 (2)	400PLUSF20

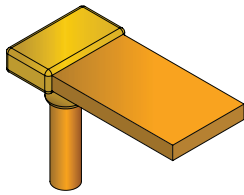

CN – ELBOW BAR ON FLAT WAY

Earth Rod Size	Bus or Lug Size (mm)	Mold	Traditional Welding Material	Cadweld Plus Welding Material
14.3mm Copper-bonded Sectional (threaded) or Plain	3 x 25	CNC16CAJ	115	115PLUSF20
	3 x 30	CNC16CAK	115	115PLUSF20
	3 x 40	CNC16CAL	150	150PLUSF20
	3 x 50	CNC16CAM	150	150PLUSF20
	4 x 25	CNC16EAJ	115	115PLUSF20
	4 x 30	CNC16EAK	150	150PLUSF20
	4 x 40	CNC16EAL	150	150PLUSF20
	4 x 50	CNC16EAM	150	150PLUSF20
	5 x 40	CNC16FAL	150	150PLUSF20
	6 x 40	CNC16PAL	150	150PLUSF20
	6 x 50	CNC16PAM	150	150PLUSF20

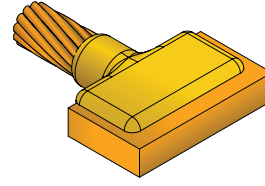

LJ - CABLE TO BUSBAR

Pro tip: The LJ connection is the easiest, simplest connection to make to busbar.

Bus or Lug Size (mm)	Conductor Size (mm ²)	Mold	Traditional Welding Material	Cadweld Plus Welding Material
5 x 40 and Wider	50	LJCFALY3	90	90PLUSF20
3 x 25	50	LJCCAJY3	90	90PLUSF20
	70	LJCCAJY4	90	90PLUSF20
4 x 25	70	LJCEAJY4	90	90PLUSF20
	95	LJCEAJY5	90	90PLUSF20
5 x 40	120	LJCFALY6	115	115PLUSF20
	150	LJCFALY7	115	115PLUSF20
5 x 40 and Wider	185	LJCFALY8	150	150PLUSF20

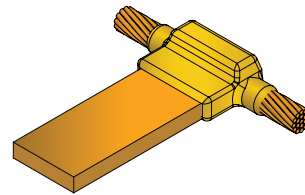

LE - HORIZONTAL CABLE TO FLAT BUSBAR OR LUG

Bus or Lug Size (mm)	Conductor Size (mm ²)	Mold	Traditional Welding Material	Cadweld Plus Welding Material
3 x 25	25	LECY1CAJ	65	65PLUSF20
	35	LECY2CAJ	65	65PLUSF20
4 x 25	50	LECY3EAJ	90	90PLUSF20
	70	LECY4EAJ	115	115PLUSF20
5 x 40	95	LECY5FAL	150	150PLUSF20
	120	LECY6FAL	150	150PLUSF20
6 x 50	150	LECY7PAM	250	250PLUSF20
	185	LECY8PAM	250	250PLUSF20

Handle Clamp / Frame (See Page 10)

Price Key*	Notes
C	REQUIRES L160 HANDLE CLAMP
F	REQUIRES L159 HANDLE CLAMP
R	REQUIRES L160 HANDLE CLAMP

*Price key is usually the third letter or digit in the mold part number.

Cable to Steel Surface

Pro tip: Make sure that the steel surface is cleaned according to the Cadweld mold instructions and use tools that do not leave residue on the surface.

Pro tip: B396 magnetic handle clamp can be used for flat vertical steel, and B160V can be used for vertical steel pipes up to 4".

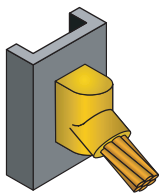

VS – CABLE TO VERTICAL STEEL

Surface	Conductor Size (mm ²)	Mold	Traditional Welding Material	Cadweld Plus Welding Material
Flat Steel	25	VSCY1	45	45PLUSF20
	35	VSCY2	45	45PLUSF20
	50	VSCY3	90	90PLUSF20
	70	VSCY4	90	90PLUSF20
	95	VSCY5	115	115PLUSF20
	120	VSCY6	115	115PLUSF20
	150	VSCY7	150	150PLUSF20
	185	VSCY8	200	200PLUSF20

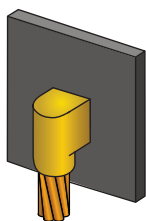

VB – CABLE TO VERTICAL STEEL

Surface	Conductor Size (mm ²)	Mold	Traditional Welding Material	Cadweld Plus Welding Material
Flat Steel	25	VBCY1	65	65PLUSF20
	35	VBCY2	65	65PLUSF20
	50	VBCY3	115	115PLUSF20
	70	VBCY4	115	115PLUSF20
	95	VBCY5	150	150PLUSF20
	120	VBCY6	200	200PLUSF20
	150	VBCY7	200	200PLUSF20
	185	VBCY8	250	250PLUSF20

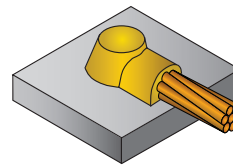

HA – CABLE TO HORIZONTAL STEEL

On Surface	Conductor Size (mm ²)	Mold	Traditional Welding Material	Cadweld Plus Welding Material
Flat Steel	25	HAAY1M	45	45PLUSF20
	35	HAAY2M	45	45PLUSF20
	50	HAAY3M	45	45PLUSF20
	70	HAAY4M	65	65PLUSF20

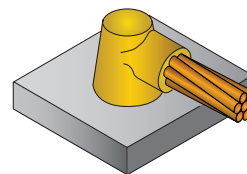

HS – CABLE TO HORIZONTAL STEEL

On Surface	Conductor Size (mm ²)	Mold	Traditional Welding Material	Cadweld Plus Welding Material
Flat Steel	95	HSCY5	115	115PLUSF20
	120	HSCY6	115	115PLUSF20
	150	HSCY7	150	150PLUSF20
	185	HSCY8	200	200PLUSF20

Handle Clamp / Frame (See Page 10)	
Price Key*	Notes
A	INCLUDES FRAME WITH HANDLE
C	REQUIRES L160 HANDLE CLAMP

*Price key is usually the third letter or digit in the mold part number.

Cable to Rebar

Pro tip: Packing of some sort is required for most rebar connections, and one is required for each weld. The packing is not optional.

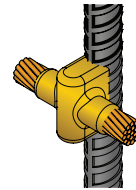
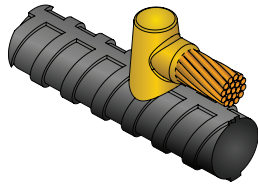

RR – CABLE TO REBAR

Rebar Size	Conductor Size (mm ²)	Mold	Traditional Welding Material	Cadweld Plus Welding Material
#4 Rebar – 13 mm	50	RRC52Y3	90	90PLUSF20
	70	RRC52Y4	90	90PLUSF20
	95	RRC52Y5	115	115PLUSF20
	120	RRC52Y6	150	150PLUSF20
#5 Rebar – 16 mm	50	RRC53Y3	90	90PLUSF20
	70	RRC53Y4	90	90PLUSF20
	95	RRC53Y5	115	115PLUSF20
	120	RRC53Y6	150	150PLUSF20
#6 Rebar – 19 mm	150	RRC53Y7	150	150PLUSF20
	50	RRH54Y3	90	90PLUSF20
	70	RRH54Y4	90	90PLUSF20
	95	RRH54Y5	115	115PLUSF20
#7 Rebar – 22 mm	120	RRH54Y6	150	150PLUSF20
	150	RRH54Y7	150	150PLUSF20
	50	RRH55Y3	90	90PLUSF20
	70	RRH55Y4	90	90PLUSF20
#8 Rebar – 25 mm	95	RRH55Y5	115	115PLUSF20
	120	RRH55Y6	150	150PLUSF20
	50	RRH56Y3	90	90PLUSF20
	70	RRH56Y4	90	90PLUSF20
#8 Rebar – 25 mm	95	RRH56Y5	115	115PLUSF20
	120	RRH56Y6	150	150PLUSF20

If purchasing Mold only ending in M, need additional B227AX frame

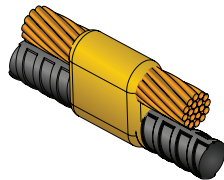

RT – CABLE TO REBAR

Pro tip: Use RTC rather than RTP, much easier rebar connection.

Rebar Size	Conductor Size (mm ²)	Mold	Traditional Welding Material	Cadweld Plus Welding Material
#3 Rebar – 10 mm	25	RTC51Y1	90	90PLUSF20
	35	RTC51Y2	90	90PLUSF20
	50	RTC51Y3	115	115PLUSF20
	70	RTC51Y4	115	115PLUSF20
#4 Rebar – 13 mm	120	RTC51Y6	150	150PLUSF20
	25	RTC52Y1	90	90PLUSF20
	35	RTC52Y2	90	90PLUSF20
	50	RTC52Y3	115	115PLUSF20
#5 Rebar – 16 mm	70	RTC52Y4	115	115PLUSF20
	95	RTC52Y5	150	150PLUSF20
	120	RTC52Y6	150	150PLUSF20
	35	RTC53Y2	90	90PLUSF20
#6 Rebar – 19 mm	50	RTC53Y3	115	115PLUSF20
	70	RTC53Y4	115	115PLUSF20
	95	RTC53Y5	150	150PLUSF20
	120	RTC53Y6	150	150PLUSF20
#6 Rebar – 19 mm	150	RTC53Y7	150	150PLUSF20
	25	RTC54Y1	115	115PLUSF20
	50	RTC54Y3	115	115PLUSF20
	70	RTC54Y4	115	115PLUSF20
#6 Rebar – 19 mm	95	RTC54Y5	150	150PLUSF20
	120	RTC54Y6	150	150PLUSF20

RC – CABLE TO REBAR

Rebar Size	Conductor Size (mm ²)	Mold	Traditional Welding Material	Cadweld Plus Welding Material
#4 Rebar – 13 mm	35	RCE52Y2	90	90PLUSF20
	50	RCE52Y3	115	115PLUSF20
	70	RCE52Y4	115	115PLUSF20
	95	RCE52Y5	150	150PLUSF20
#5 Rebar – 16 mm	35	RCE53Y2	90	90PLUSF20
	50	RCE53Y3	115	115PLUSF20
	70	RCE53Y4	115	115PLUSF20
	95	RCE53Y5	150	150PLUSF20
#6 Rebar – 19 mm	35	RCE54Y2	90	90PLUSF20
	50	RCE54Y3	115	115PLUSF20
	70	RCE54Y4	115	115PLUSF20
	95	RCE54Y5	150	150PLUSF20
#7 Rebar – 22 mm	35	RCE55Y2	90	90PLUSF20
	50	RCE55Y3	115	115PLUSF20
	70	RCE55Y4	115	115PLUSF20
	95	RCE55Y5	150	150PLUSF20
#8 Rebar – 25 mm	35	RCE56Y2	90	90PLUSF20
	50	RCE56Y3	115	115PLUSF20
	70	RCE56Y4	115	115PLUSF20
	95	RCE56Y5	150	150PLUSF20

If purchasing Mold only ending in M, need additional M2322 frame

Rebar Packing

P/N	Description	Qty. Per Carton
B140A	Copper Shim, 0.3 mm x 76 mm x 38 mm	50
B140B	Copper Shim, 0.3 mm x 76 mm x 64 mm	50
B141A*	Copper Shim, 0.3 mm x 76 mm x 38 mm	50
B143A	Ceramic Packing, 6 mm x 44 mm x 45 mm	20
B143B	Ceramic Packing, 6 mm x 50 mm x 44 mm	20
B144A	Ceramic Packing, 6 mm x 76 mm x 76 mm	20
B144B	Ceramic Packing, 6 mm x 76 mm x 76 mm	20
B144C	Ceramic Packing, 6 mm x 76 mm x 76 mm	20

*Each piece of B141A includes 2 copper shims as required per rebar connection

Handle Clamp / Frame (See Page 10)

Price Key	Notes
C	REQUIRES L160 HANDLE CLAMP
E	REQUIRES L160 HANDLE CLAMP
H	INCLUDES TOGGLE FRAME WITH HANDLE

Note: Any Cadweld connection to rebar using greater than 150 weld metal requires Engineering approval.

Materials, Tools & Accessories



Traditional Cadweld



Cadweld Plus



L160
Handle Clamps



T313 (165040)
Card Cleaning Brush

Cadweld Welding Material				
Traditional		Cadweld Plus		Qty. Per Carton
Article Number	Description	Article Number	Description	
163590	15	165700	15PLUSF20	20
163000	25	165701	25PLUSF20	20
163010	32	165702	32PLUSF20	20
163020	45	165703	45PLUSF20	20
163030	65	165704	65PLUSF20	20
163040	90	165705	90PLUSF20	10
163050	115	165706	115PLUSF20	10
163060	150	165707	150PLUSF20	10
163070	200	165708	200PLUSF20	10
163080	250	165709	250PLUSF20	10
*	2(150)	165710	300PLUSF20	10
*	2(200)	165711	400PLUSF20	10
163090	500	165712	500PLUSF20	10

*These larger sizes of Traditional Weld Metal do not exist. Users will need to combine multiple units of smaller sizes of weld metal.

ADAPTING MOLDS TO FIT CONDUCTORS

Cables smaller than indicated on mold tag can be welded by using either Wrap Sleeves or Adapter Sleeves



nVent ERICO Cadweld Wrap Sleeve B140A

Cadweld Wrap Sleeve is wrapped around the cable until the diameter is about the same as the cable opening in the mold.



nVent ERICO Cadweld Adapter Sleeves

Cadweld Adapter Sleeves are used to adapt a limited range of smaller size cables to a larger size Cadweld mold.

MOLD CLEANER



B136A (182125) For use with most Cadweld molds using 65 welding material and smaller

B136B (182130) For use with most Cadweld molds using 90 welding material and larger



T314 (165130)
Cable Cleaning Brush



T321 (162630)
Rasp



T394 (162427)
Mold Cleaning Brush



T403 (165280)
Mold Sealer



T320 (165000)
Flint Ignitor



PLUSCU2L6
nVent ERICO Cadweld Plus Impulse Exothermic Welding Control Unit



T111 (165170)
Surefire™ Torch Head



B160V
Chain Support Clamp



B396 (161632)
Magnetic Handle Clamp



B265 (165020)
Cable Clamp

nVent ERICO Cadweld Molds

A graphite mold is used for making most nVent connections. nVent molds will generally last an average of 50 or more connections under normal usage.

Price Key and Handle Clamp and/or Frames

Handle clamps are required for most molds. Specialized frames with handles are used on some molds. The following handle clamps are most widely used.

L160 for all molds having a "C", "E", "R" and "Q" mold price key (3" wide molds)

L159 for all molds having a "D", "F", "J" and "Z" mold price key (4" wide molds)

Handle Clamps with an "XL" prefix are for use with the Cadweld Exolon system. Mini E-Z Change Clamps for use with mini-welders.

Pictured Below are the Molds and / or Frames and Handles for the various Price Key Molds. The price key is usually the third letter or digit in the mold part number:

PRICE KEY MOLDS: A, C, D, F, R, Q, Z, E, J



"A" Price Key Mold
Includes Hold Down Frame



"C", "D", "F", "R", "Q" and "Z" Price Key
Mold L160 or L159
Handle Clamp Required (sold separately)



"E" and "J" Price Key Mold
L160 or L159 Handle Clamp Required
(sold separately)

Note: Frame is required in order to make connections with "E" and "J" Price Key Molds.

PRICE KEY MOLDS: Q, Z, 3, 4, M, V

Pro tip: XBQ and XBZ, as well as the XB3 and XB4 molds simplify making cable "X" connections. These are preferred molds as compared to the older XBM and XBV versions.

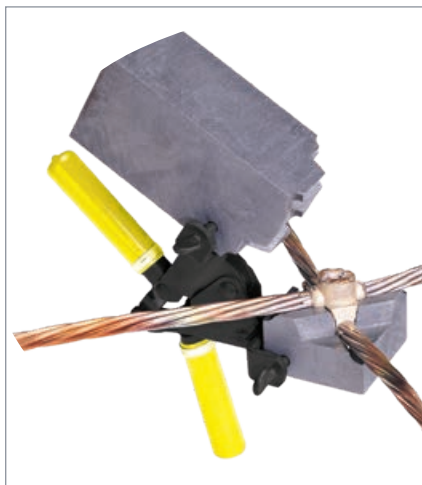

"Q" and "Z" Price Key Mold
L160 or L159 Handle Clamp Required
(sold separately)

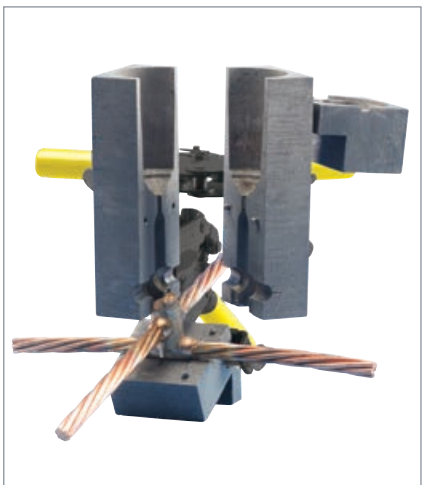

"3" and "4" Price Key Mold
Mold L163 or L164
Handle Clamp Required (sold separately)



"M" and "V" Price Key Mold
Includes Frame with Handles

Note: Frame is required in order to make connections with "M" and "V" Price Key Molds.

nVent ERICO Cadweld Molds

PRICE KEY MOLDS: H, G, K, L, T, P, N



"H" Price Key Mold
Includes Hold Down Frame with Handles

Note: Frame is required in order to make connections with "H" Price Key Molds.



"G", "K", and "L" Price Key Mold Includes Frame with Handles

Note: Frame is required in order to make connections with "G", "K" and "L" Price Key Molds.



"T", "P" and "N" Price Key Mold
Includes Mini-EZ Handle Clamp
To order mold only, add an "M" suffix to the part number (for example, SST1TM)

MOLD OPTIONS



SPLIT CRUCIBLE MOLDS

Molds made with a horizontal opening and solid crucible section may be specified as a split crucible type. The advantage of the split crucible mold is easier cleaning.

To order a mold with a split crucible, add an "L" suffix to the mold part number (for example, TAC2G2GL).



WEAR PLATES

Wear Plates reduce mechanical abrasion of molds at cable entry points and help prevent leakage of molten metal (particularly on larger 7 strand conductor). These features prolong mold life.

To order a mold with wear plates, add a "W" suffix to the mold part number (for example, PTC2G2GW).



HEAVY DUTY MOLDS

Heavy Duty (HD) molds are available for making connections to existing ground conductors that may be corroded. HD molds require larger weld metal sizes than traditional molds.

To order a heavy duty mold, add a HD prefix to the mold part number (for example, HDTAC2Q2Q).

Our powerful portfolio of brands:

CADDY ERICO HOFFMAN RAYCHEM SCHROFF TRACER



[nVent.com/ERICO](https://www.nVent.com/ERICO)