

PHILIPS

Ultinon Pro

H4-LED

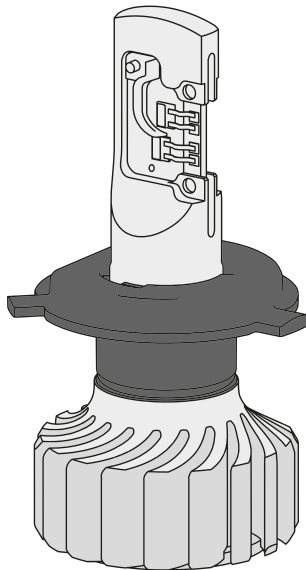



H4-LED



ALLGEMEINE BAUART-GENEHMIGUNG (ABG) / APPROVAL DOCUMENT

Zugelassenen Fahrzeugtyp und Genehmigungsnummer der Scheinwerfer prüfen.
Check approved vehicle type and approval mark of the headlamps.



Kraftfahrt-Bundesamt

DE-24932 Flensburg

ALLGEMEINE BAUARTGENEHMIGUNG (ABG)

nach § 22a der Straßenverkehrs-Zulassungs-Ordnung (StVZO) in der Fassung vom 28.05.1986 (BGBl I S.1763) in Verbindung mit der Verordnung über die Prüfung und Genehmigung der Bauart von Fahrzeugteilen sowie deren Kennzeichnung (FzTV) in der Fassung vom 12.08.1998 (BGBl I S. 2142)

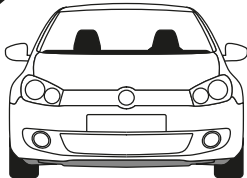

Achtung!



Nicht berühren!
Do not touch!

**Bitte Handbuch ihres Fahrzeugs prüfen und
den Anweisungen zum Lampenwechsel
folgen.**

Please check car installation manual and
follow instructions for lamp replacement.



H4-LED

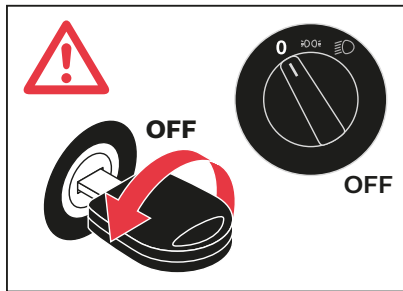
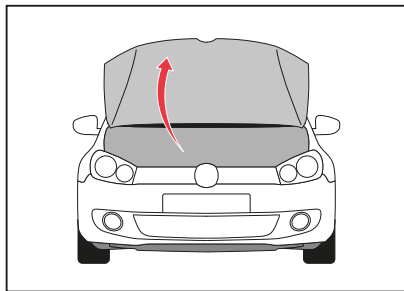
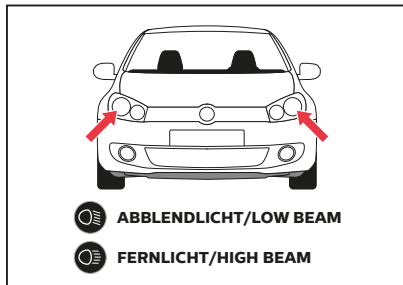
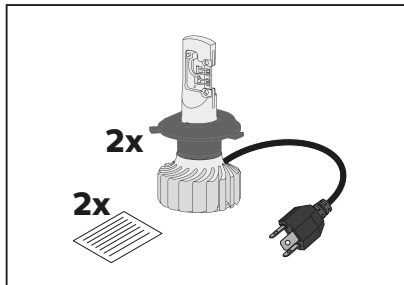

Option 1 (Gummi-Kappe)

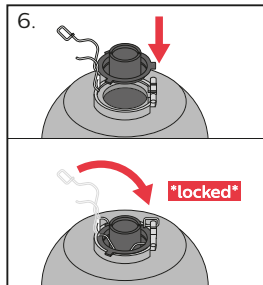
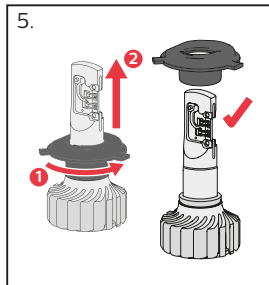
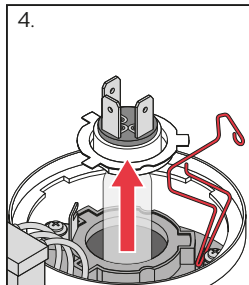
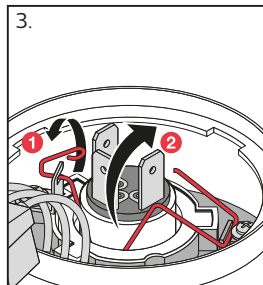
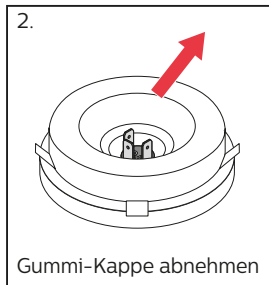
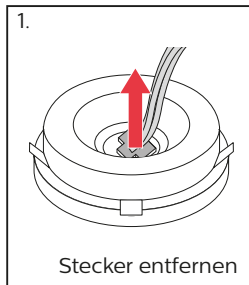

Option 1 (Gummi-Kappe)

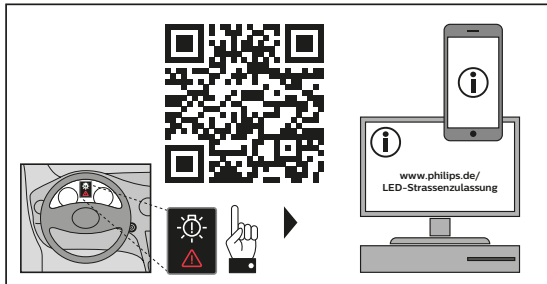
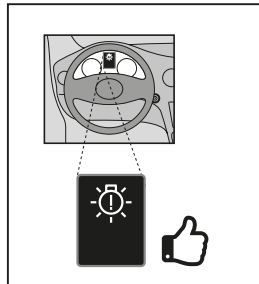
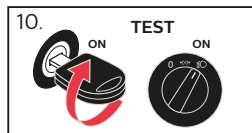
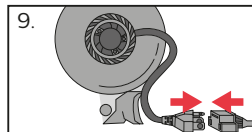
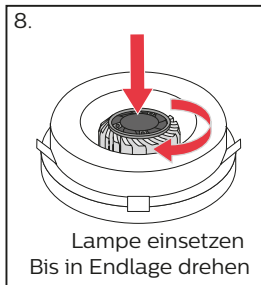
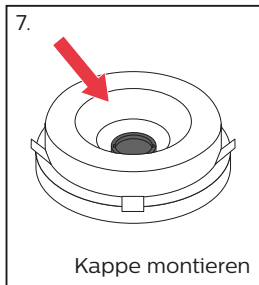

Option 2 (Kunststoff-Deckel)

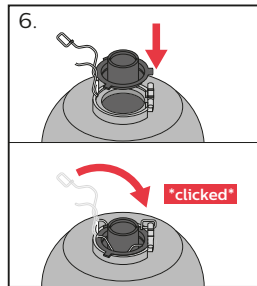
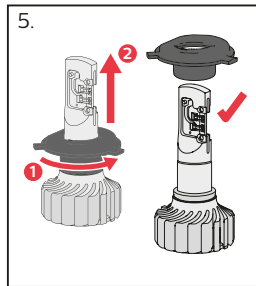
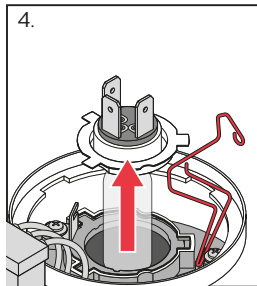
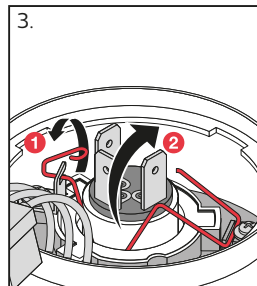
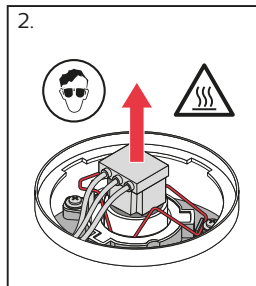
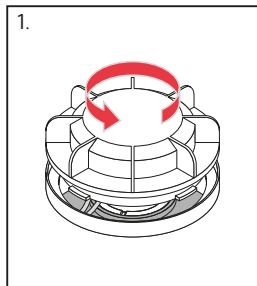

Option 2 (Kunststoff-Deckel)

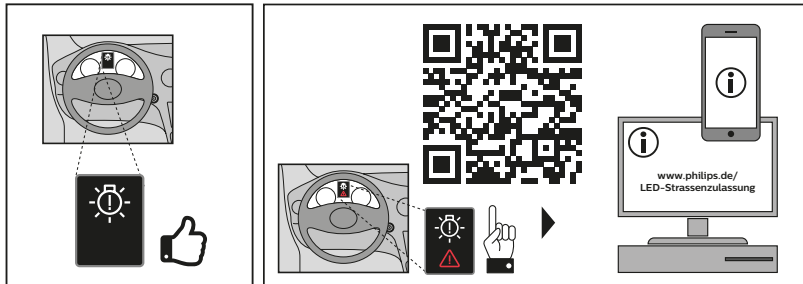
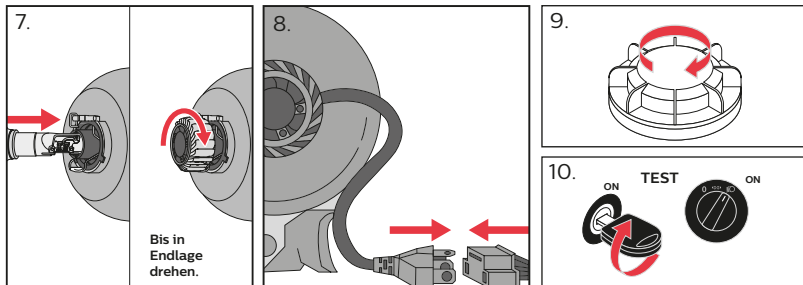

Option 3 (Feder)

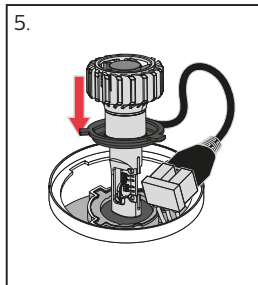
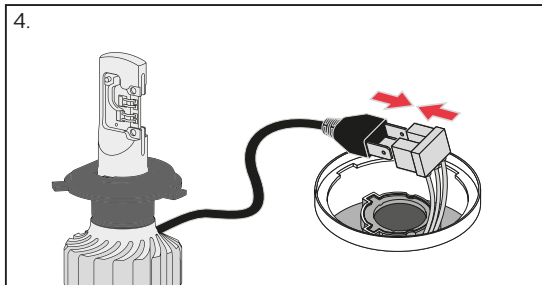
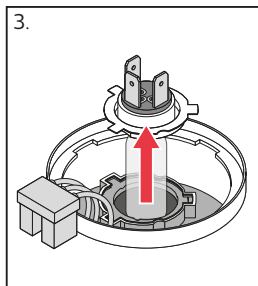
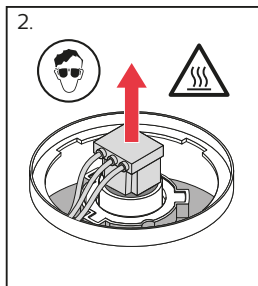
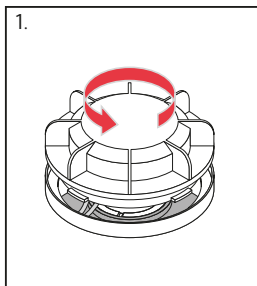

Option 3 (Feder)

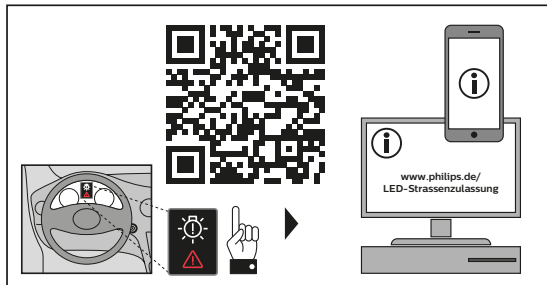
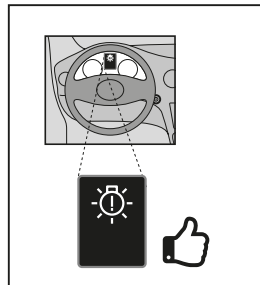
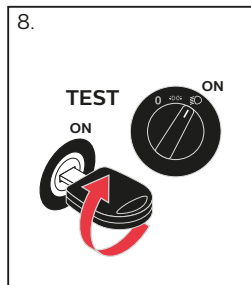
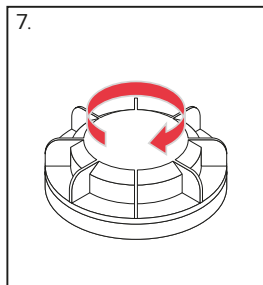
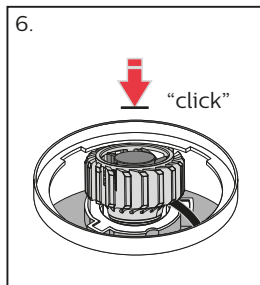

H4-LED CANbus

LED CANbus

Bitte prüfen Sie den erlaubten Verwendungsbereich mit der Kompatibilität ihres Fahrzeugs.
Please check the allowed range of application with the compatibility of your vehicle.

PKW Modell Car model	CANbus Typ CANbus type
#1	“xyz”
#2	...

Genauere Informationen in der spezifischen Einbauanleitung des CANbus
Detailed information in the specific installation instructions of the CANbus

Allgemeine Anleitung – ABG Zertifikat

So erhalten Sie die ABG (allgemeine Bauartgenehmigung) für die Straßenzulassung für Ihr Fahrzeug:

How to get general type approval (ABG) for use in your vehicle on public roads:

- 1. Scannen Sie den QR-Code an der Oberseite der Verpackung, um das Produkt zu authentifizieren und das ABG-Zertifikat herunterladen zu können.**

Scan the QR code on the top of the packaging to authenticate the product and download the ABG certificate.
www.philips.de/LED-Strassenzulassung

- 2. Drucken Sie das Zulassungsdocument (ABG) aus.**
Print out the approval document (ABG).

- 3. Führen Sie die Allgemeine Bauartgenehmigung (ABG) stets im Fahrzeug mit sich.**

Keep the approval certificate (ABG) at all times with you in the vehicle.

Sie selbst sind für die Einhaltung aller geltenden gesetzlichen Vorschriften verantwortlich.

You are responsible to comply with all applicable legal requirements.



Allgemeine Anleitung – Linksverkehr

Diese LED Austauschlichtquelle ist nur für Rechtsverkehr zugelassen. Vor einer Fahrt in ein Land mit Linksverkehr, muss die LED Lampe durch eine Halogenlampe ausgetauscht werden.

This LED replacement light source is only approved for right-hand traffic. Before entering a country with left-hand traffic, the LED lamp must be replaced by a halogen lamp.

Bitte Handbuch ihres Fahrzeugs prüfen und den Anweisungen zum Lampenwechsel folgen.

Please check car installation manual and follow instructions for lamp replacement.

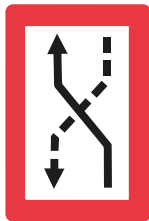

Allgemeine Anleitung – Montage

Bitte Lampen paarweise austauschen.
Please change lamps in pairs.

Die LED Lichtquelle, Kabel und die zugehörigen Bauteile müssen so installiert werden, dass es zu keiner Beschädigung oder Beeinträchtigung der Funktion des Scheinwerfers kommt. Alle Teile müssen ordnungsgemäß befestigt werden.

Prüfen Sie die korrekte Position und den sicheren Halt der LED Lampe in der Lampenfassung

The LED light source, cables and components must be mounted in a way that the headlamp won't be damaged and that its function is maintained. All parts must be fixed safely.

Check correct position and safe fixation of LED lamp within the lamp holder.

Nach dem Austausch der Scheinwerferlampe ist eine Überprüfung und ggf. Anpassung der Scheinwerfereinstellung durch eine qualifizierte Werkstatt erforderlich.

The replacement of the lamp in the headlamp requires inspection and eventually adjustment of headlamp setting by a qualified garage.

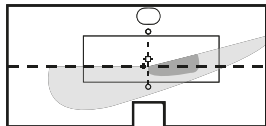
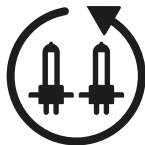

Allgemeine Anleitung – Sicherheit

Der Austausch der Halogenlampe durch eine LED Lichtquelle wird das Enteisungsverhalten und die Enttawung der Scheinwerfer verändern.

The replacement of the halogen lamp by an LED light source may affect the deicing and defogging behavior of the headlamp.



Die LED Lichtintensität ist im Betrieb sehr hoch. Bitte nicht direkt in das Licht schauen um mögliche Schädigung der Augen zu vermeiden.

The LED light intensity is very high while turned on. Do not look directly into the beam to avoid damage to the eyes.



Bitte Schutzbrille tragen beim Austausch von Halogenlampen.

Please wear safety glasses while replacing halogen lamps



Die Lampen heizen sich im Betrieb auf. Nicht berühren. Bitte abkühlen lassen, um mögliche Verbrennungen durch Kontakte mit heißen Oberflächen zu vermeiden.

Lamps will heat up during operation. Do not touch. Please let it cool down in order to avoid potential injury due to contact with hot surface.



Bitte Schutzhandschuhe tragen um Verletzungen bei der Montage zu vermeiden.

Please wear safety gloves to avoid injuries during mounting.



Außerhalb der Reichweite von Kindern aufbewahren.

Keep out of reach of children.





**Lumileds ist der Garantiegeber für dieses Produkt.
Philips und das Philips Wappen sind eingetragene Marken von
Koninklijke Philips N.V. und werden unter Lizenz verwendet.
©2021 Lumileds Holding B.V. Alle Rechte vorbehalten.**

Lumileds is the warrantor of this product.
Philips and the Philips Shield Emblem are registered trademarks of
Koninklijke Philips N.V. and are used under license.
© 2021 Lumileds Holding B.V. All rights reserved.

