

MX SERIES

MXi|MX INSTRUCTION MANUAL

Table of Contents

Product Overview	01 / 04
Introduction / Warnings	05 / 06
Battery Operation / Battery Maintenance	07 / 09
Battery Installation	07
Charging the Battery	08
Master Code Programming	10
Smart Align Biometric Programming (MXi Only)	11 / 14
Helpful Programming TIPS	11
Programming 1st and 2nd Fingerprints	12
Programming Additional Fingerprints 3-20	13
Deleting Fingerprints	14
Smart Key Operation / Smart Key Warnings	15 / 18
Smart Key Pairing	15
Toggle Smart Key Entry Modes	16
To Unpair Smart Key	16
Multiple Safe Management	17
Hot Keys	18 / 20
Tamper Detection	18
Toggle Stealth Mode	18
Toggle Travel Mode	18
View Battery Status	19
Delete Fingerprints	19
Toggle Interior Light	19

Toggle LCD Brightness	19
Toggle Bluetooth®	20
Toggle Open Door Alarm	20
Toggle Smart Key Modes	20
Toggle DMT Sensitivity	20
Toggle Dual Entry Mode	20
Toggle Alert of Manual Unlock	20
Vaultek® App Features / App Pairing	21 / 22
Securing Your Safe	23
Modular Interior	23
Adjust Interior Shelf Height	23
Product Registration	24
FAQ	25 / 26
Troubleshooting	27
Customer Support / Warranty	28

Box Contents

Vaultek® Safe
Smart Key and Battery
18650 Rechargeable Lithium-ion Battery
AC Power Adapter and Charging Cable

Twin Pistol Rack
Hardware Mounting Kit
Owner's Manual / Quick Start Guide
Backup Keys (2)

GET STARTED

[VAULTEKSAFE.COM/
MXSERIES-SUPPORT](http://VAULTEKSAFE.COM/MXSERIES-SUPPORT)

ONLINE TUTORIALS
Quick setup help.

Product Overview

Get to know your Vaultek® safe.

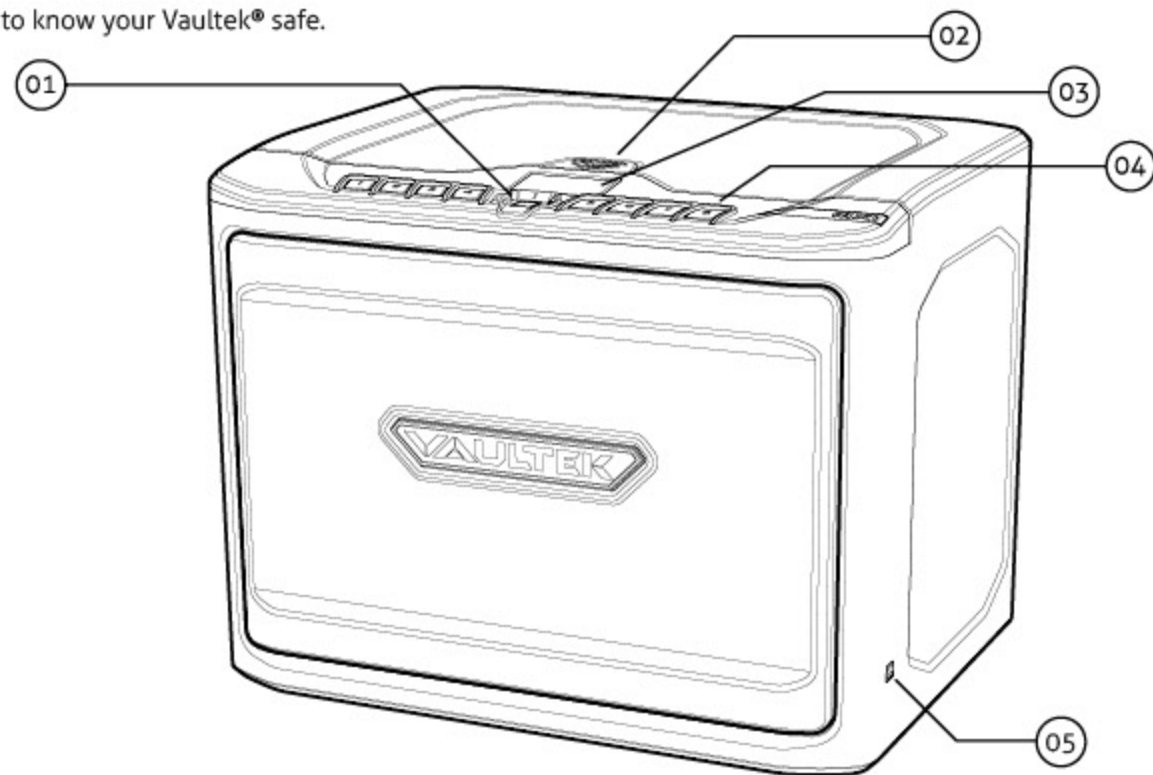

01. Smart Align Biometric Scanner (MXi Only)

02. Silicone Key Hole Cover

03. LCD Screen

01 Vaultek®

04. Numeric Keypad

05. Micro-USB Charging Port

LCD Screen Format

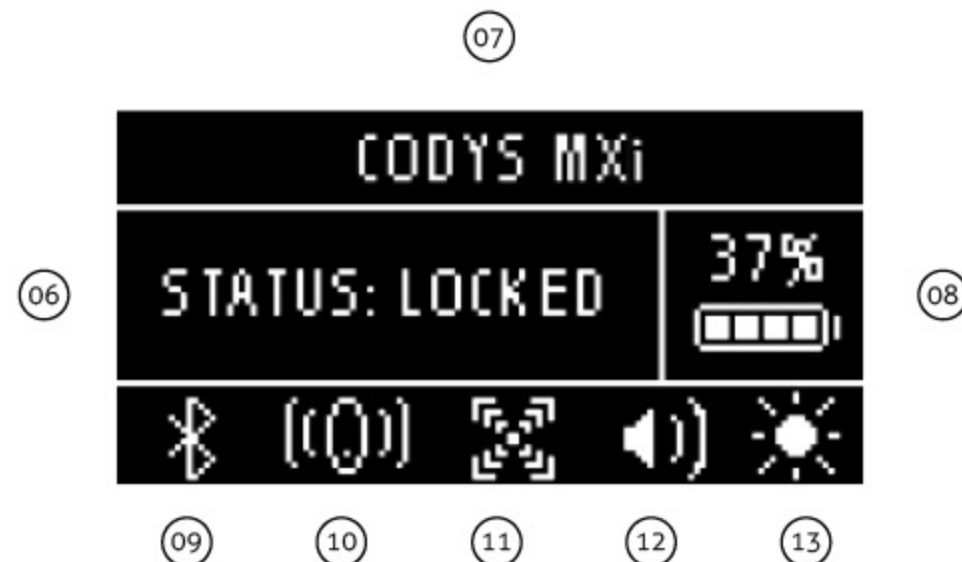

06. Safe Status

07. Safe Name

08. Battery Level

09. Bluetooth®

10. Smart Key

11. Impact Detection

12. Sound

13. Interior LED

02 Vaultek®

Product Overview

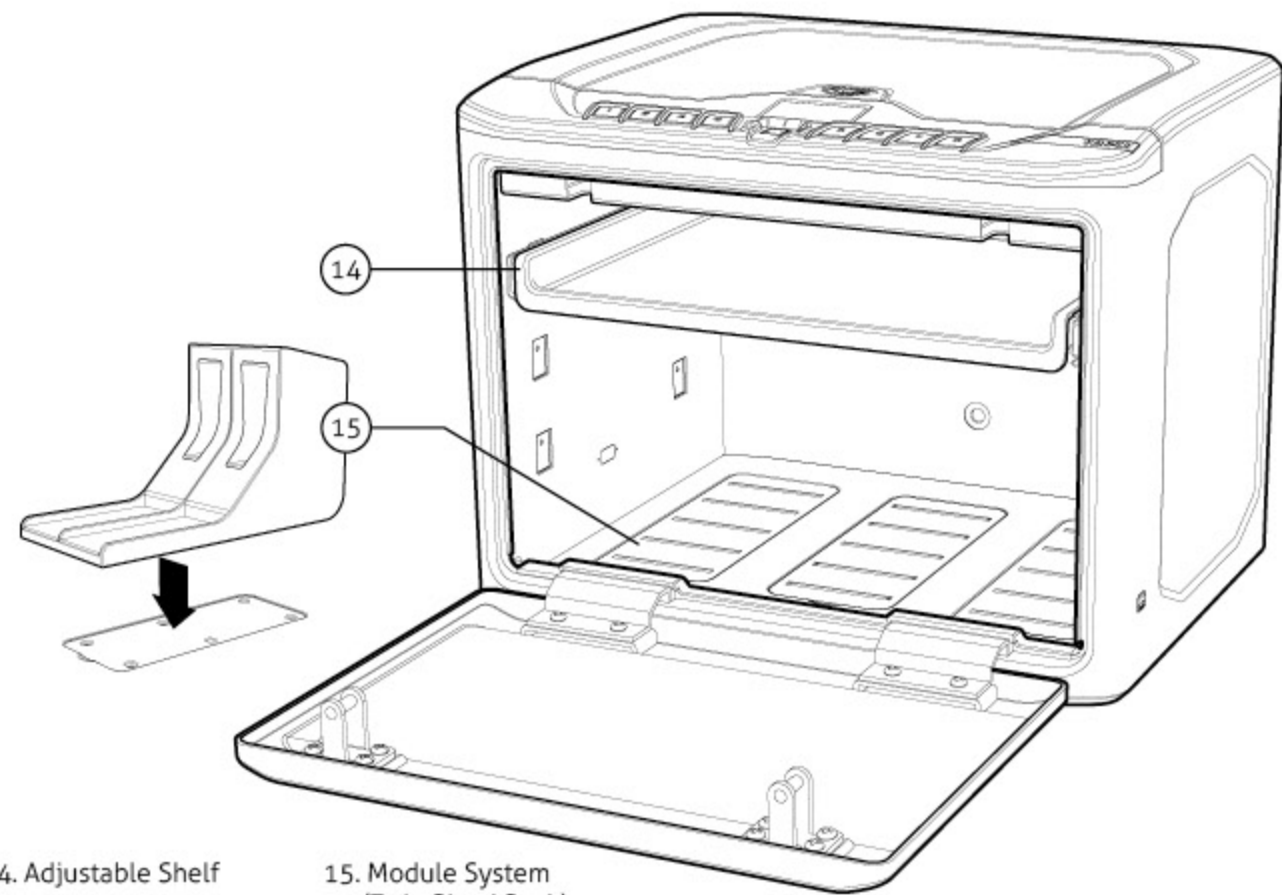

14. Adjustable Shelf

15. Module System
(Twin Pistol Rack)

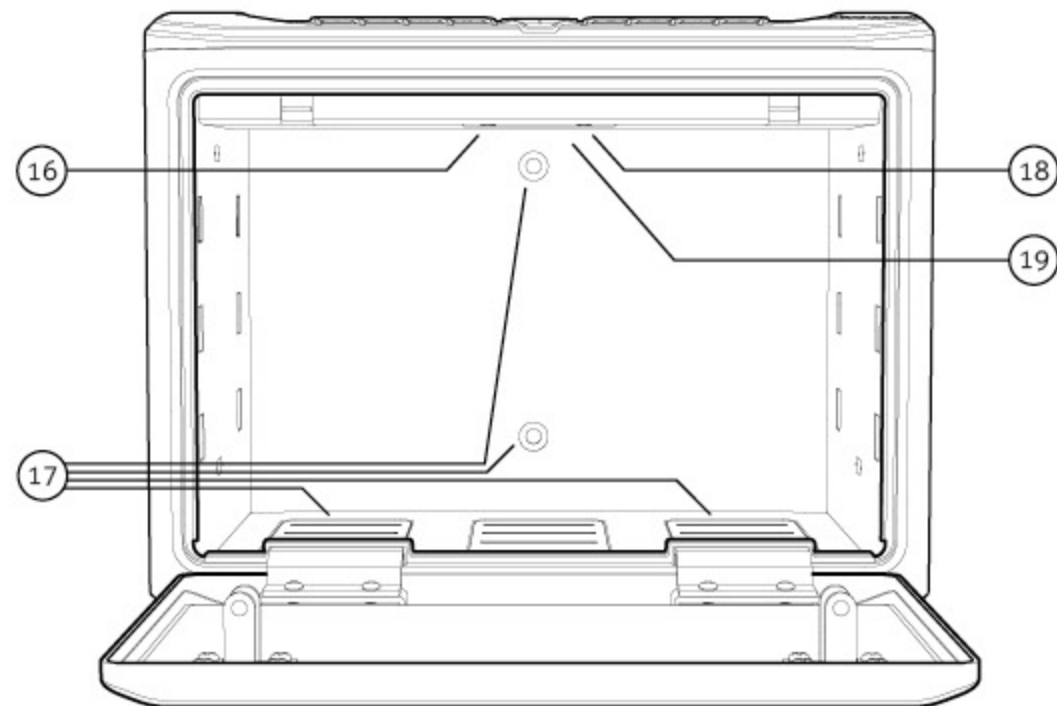

16. PROGRAM Button

17. Pre-Drilled Mounting Holes

18. LED Light Button

19. Battery Compartment

Introduction

The Vaultek® MX Series safe is a biometric (MXi Only), PIN access / Bluetooth® access safe. Its solid structure and penetration resistant design makes it ideal for storing valuables such as firearms, jewelry, cash, and other personal items. Powered by a rechargeable lithium-ion battery, the safe combines high security with complete access control.

Secure Access: How to open your Vaultek® Safe.

Biometric Scanner (MXi Only): Personalized access for up to 20 fingerprints. See pages 11 to 14.

Keypad: The numeric keypad responds quickly for rapid access and has a built-in proximity sensor that lights up when your hand brushes against the safe. See page 10 for more information.

Smart Key: Remote for on demand access. See page 15 and 18 for more information.

Vaultek® App: Open the safe with the Bluetooth® app. See pages 21 and 22 for more information.

Key: Two keys are provided for manual access to the safe in the event the battery dies.

Secure Defense: How your Vaultek® Safe keeps people out.

Anti-Impact Latches: Built to withstand forceful impacts and heavy slams.

No External Access Points: A combination of interior mounted hinges and extended anti-pry reinforcement bars help prevent unwanted tools from attempting to break the safe open.

Security Sleep Mode: Activates when six (6) consecutive incorrect keypad entries are entered or (6) incorrect fingerprint scans are made. The safe will not accept any entries for four minutes. If any additional attempts are made the alarm will beep. The security sleep mode can be cleared upon unlock of the safe by any authorized access method including the backup keys.

DMT (Impact Detection): Motion activated alarm can be disabled or enabled with three levels of sensitivity (Low, Medium, and High) using the Vaultek® app or hot key functions. See page 20 for information.

Warnings

To prevent damage to your Vaultek® unit or injury to yourself or to others, read the following safety precautions before using this unit.

DO NOT PLACE OR STORE THE BACKUP KEYS INSIDE THE SAFE AT ANY TIME. IF THE BATTERY FAILS, YOU WILL BE UNABLE TO OPEN THE SAFE.

DO NOT expose to extreme heat or cold. Battery power may be affected.

DO NOT store loaded guns in this unit. Firearms are serious in nature and must be handled with respect. Store responsibly.

DO NOT get fingerprint sensor wet.

ALWAYS check to make sure door has latched when closing; lid requires a firm press and locks automatically.

DISCLAIMERS:

NEITHER SELLER NOR MANUFACTURER SHALL BE LIABLE FOR UNAUTHORIZED ACCESS, ANY INJURY, LOSS OR DAMAGE TO PERSONAL PROPERTY DIRECT OR CONSEQUENTIAL, ARISING OUT OF THE USE OF, OR THE INABILITY TO USE THE VAULTEK® SAFE.

THE USER SHALL DETERMINE THE SUITABILITY OF THE VAULTEK® SAFE BEFORE THE INTENDED USE AND USER ASSUMES ALL RISK AND LIABILITY WHATSOEVER IN CONNECTION THEREWITH. VAULTEK® SAFES ARE NOT INTENDED TO PROTECT AGAINST ENVIRONMENTAL HAZARDS INCLUDING FIRE AND WATER.

Be sure and follow all local and state firearm laws.

DO NOT operate a firearm without proper training and experience.

Check page 18 for Smart Key warnings.

The Bluetooth® word mark and logos are registered trademarks owned by the Bluetooth SIG, Inc. and any use of such marks by Vaultek Safe, Inc. is under license.

Battery Operation

Your safe uses a 3.7V 18650 rechargeable lithium-ion with a flat top. A minimum 2000 mAh capacity is required, however 2200 mAh or higher can be used to increase operation time.

Battery Installation

- 1 To get started, insert one of your backup keys into the keyhole at the top of the safe (see Figure A). Push key in and rotate the key 90 degrees clockwise to open the safe.
- 2 Locate the battery compartment inside the safe beneath the control panel (see Figure B).
- 3 Remove the battery cover by pressing down on the tab near the top of the cover.
- 4 Insert the 18650 rechargeable lithium-ion battery (included in accessory box) into the battery compartment. Note that your Vaultek® safe automatically detects the polarity of the battery and can be installed in either direction.

TIP! For easy removal make sure to place the pull string over the battery before closing the door.

- 5 When the battery is inserted you will hear a short welcome tone and the keypad will light up. Once you hear the tone replace the battery cover. You are now ready to program your safe.

IMPORTANT Your Vaultek® safe will automatically lock when you fully close the lid.

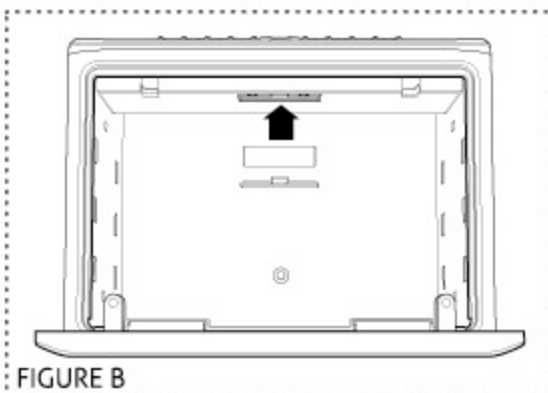
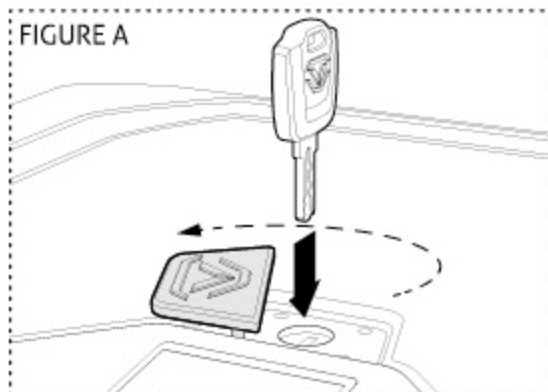

FIGURE B

Continue on next page for more information about the battery.

Charging the Battery

Your Vaultek® safe is powered by a rechargeable lithium-ion battery and comes with a charging kit which includes an AC power adapter and a micro-USB cable. Safe and micro-USB cable can be used with all international power adapters. Under normal usage, a fully charged battery can last 3 months.

Due to powerful features with MX Series it is recommended to keep the safe plugged in.

To recharge the safe, plug the micro-USB cable into the micro-USB receiving jack located on the lower right side of the safe (Figure C) and connect to a standard USB port or wall outlet using the AC power adapter. Approximate recharge time is 3.5 hours.

When charging the LED light above the micro-USB jack (Figure C) will be solid RED and GREEN indicating charged.

Charging TIPS

- A After installing the battery, use the charging kit provided to charge the unit 100%.
- B The charging kit can also function as an external power supply, which means you can open your safe even when the battery is depleted.
- C Leaving your safe plugged in continually will **not** harm the safe or battery. However, to preserve battery life we suggest that you unplug occasionally to allow the battery to cycle down.
- D A specially designed Vaultek Powerpack is available as a separate accessory to extend operation time.
- E The adapter used to charge the battery should output 5V/2000mA or above when using micro-USB cable. See the FAQ section for additional information about the battery.

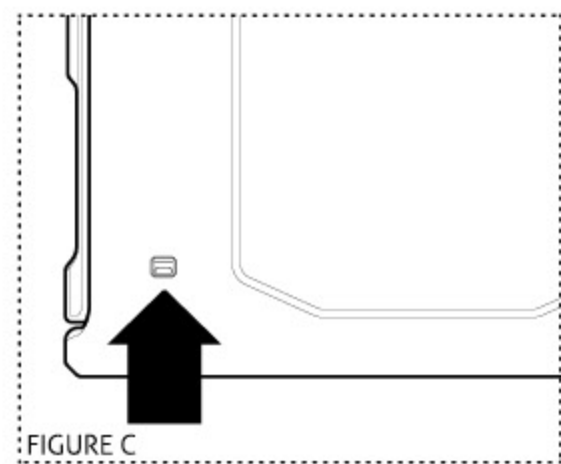

FIGURE C

Battery Maintenance

Testing the Battery Power

To check the battery level, press and hold '6' and '8' key together on the keypad for 3 seconds. The LCD screen will indicate the battery level.

Low Battery Warning

If the LED on the control panel blinks RED several times and you hear several rapid beeps when opening the safe, your battery level is critical low and your safe needs to be recharged immediately.

Soft Reset TIP

In the event the battery dies or a soft reset is performed (battery removal and installation) the safe will restore default settings for DMT, interior light, sound, Alert of Manual Unlock, and the Smart Key. These settings will need to be readjusted, however the master code and fingerprint scanner will not be affected.

IMPORTANT

Use a 3.7V 18650 rechargeable lithium-ion battery with a flat top. A minimum 2000 mAh capacity is required, however 2200 mAh or higher can be used to increase operation time.

A high capacity battery upgrade is available as an accessory through our website.

The adapter used to charge the battery should output 5V/2000mA or above when using micro-USB.

TUTORIALS ONLINE AT VAULTEKSAFE.COM/MXSERIES-SUPPORT/

Master Code Programming

First time users should change the default code as soon as possible to prevent unauthorized access to your safe. You will also use this master code to pair the Vaultek® app on your smartphone, so it should be kept confidential.

TIP: Code Requirements

- Your code can be a minimum of 4 and a maximum of 8 digits. We recommend a code 6 to 8 digits in length using at least one of each key to make it more difficult for someone to guess your code. For your security, the safe will time out and sleep for 4 minutes if 6 incorrect entries are made.
- Two keys cannot be pressed simultaneously.
- Programming a new code will overwrite your previous code.
- TIP!** The Vaultek® app will ask for your safe's master code during pairing and anytime you change the code the app will ask you to re-enter it.

- Open the safe. With the safe open, press and hold the '1' key then the "PROGRAM" button together (3 seconds)(Figure D) until the screen prompts you to enter your new code.
- Enter your NEW master code.
- Press and hold the '1' key then the "PROGRAM" button together a second time (3 seconds) until the screen prompts you to reenter your new code.
- Enter your NEW master code a second time.
- Press and hold the '1' key then the "PROGRAM" button together a third time (3 seconds) until the safe beeps and the screen confirms the code has been reset.

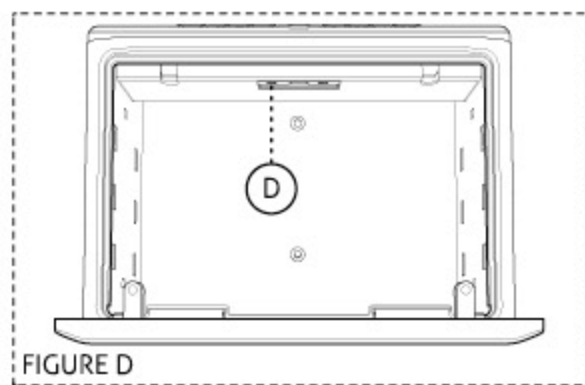

FIGURE D

If you make a mistake and the new code will not work, simply start over with step 1.

Smart Align Biometric Programming

Biometrics are methods of authenticating the identity of a person based on physical or behavioral characteristics. Biometric fingerprint authentication refers to technology that measures and analyzes human physical characteristics for identification and authentication purposes. The smart align biometric system guides your finger placement for consistent and accurate results.

Everyone has their own unique fingerprints, and what makes them unique is the pattern of ridges, valleys, and minutiae points that comprise an individual print. Vaultek® and their leading engineering group has developed proprietary technology to read and match fingerprints with unmatched speed and accuracy. That means that only authorized users have access to your valuables. The safe is capable of storing fingerprint data for up to 20 unique authorized users. A user consists of 5 scans of the same finger during registration. Once a user's fingerprint data is stored in the safe and encrypted, it cannot be copied or stolen.

Helpful Programming TIPS

- **Place the core of the fingerprint flat** (Figure E+F) over the center of the scanner in line with the side LEDs (this allows the scanner to read where most of the fingerprint detail is located) see (Figure E).
- Adjust your finger slightly between scans for increased accuracy.
- Excessive moisture, lotions, or dirt will affect your fingerprint and may cause inaccurate sensor reading.
- If you are experiencing difficulty try different fingers. Each finger is unique and some fingers, such as your thumb, contain more readable information than others.
- To increase success rate register the same fingerprint multiple times.

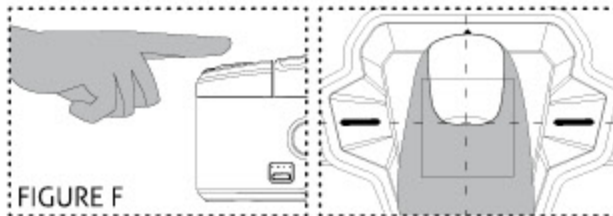
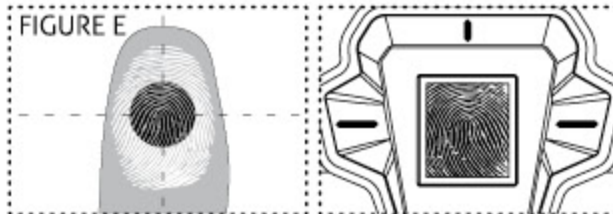

ATTENTION! (Figure F)

Position your finger flat against the scanner to increase the amount of readable information.

Continue on next page for more information about the fingerprint scanner.

Programming the 1st and 2nd Fingerprints

The 1st and 2nd fingerprints will be recognized as administrative fingerprints and will be used to authorize additional users. To program additional users please refer to the next page.

- 1 Open the safe. Program 1st fingerprint by pressing and holding the '2' key then the "PROGRAM" button together (3 seconds)(Figure G) until the screen prompts you to scan the 1st of five scans.
- 2 Using the helpful programming tips provided on page 11 place your finger on the fingerprint scanner for the 1st of five scans. When the safe beeps, and the screen prompts the next scan remove your finger. If the screen indicates a failed to complete then start over with step 1.
- 3 Place finger again over the scanner until the safe beeps and the screen prompts the next scan and lift. You will repeat this process until all scans (1-5) are programmed.
- 4 Close door and test to see if the safe will open using your fingerprint. If you experience issues refer to the helpful programming tips listed on page 11 or check our tutorials online at vaulteksafe.com/mxseries-support/.
- 5 Repeat steps 1 through 4 to add the 2nd administrative fingerprint.

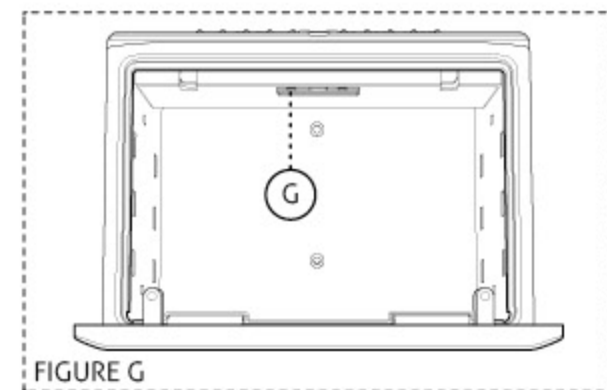

Continue on next page to program fingerprints 3-20.

TUTORIALS ONLINE AT VAULTEKSAFE.COM/MXSERIES-SUPPORT/

Smart Align Biometric Programming (MXi Only)

Programming Additional Fingerprints 3-20

The first two fingerprints programmed into the safe are the administrative fingerprints. Any additional users programmed require authorization from one of these fingerprints.

- 1 Open the safe. Program additional fingerprints by pressing and holding the '2' then "PROGRAM" button together (3 seconds)(Figure G on page 12). The screen will prompt you to scan one of the administrative fingerprints.
- 2 Place one of the first two programmed administrative fingerprints on the scanner and remove when the safe beeps and screen authorizes the print. You can now program a NEW fingerprint.

TIP: If the administrative print is left on the scanner too long the safe will begin to program that fingerprint into the safe again and not the NEW fingerprint. If this happens start over with step 1.

- 3 Using the helpful programming tips provided on page 11 place the NEW finger on the scanner. When the safe beeps and the screen prompts the next scan remove your finger.
- 4 Place finger again over the scanner until the safe beeps and the screen prompts the next scan and lift. You will repeat this process until all scans (1-5) are programmed.

TUTORIALS ONLINE AT VAULTEKSAFE.COM/MXSERIES-SUPPORT/

Deleting Fingerprints

Individual fingerprints can not be deleted from the keypad on the safe. Following this procedure will erase all of the fingerprints including both administrative fingerprints. If you wish to delete individual fingerprints, you must use the Vaultek® app. This procedure will not affect the keypad master code.

- 1 Press and hold the '3' key then the "PROGRAM" button together until the safe beeps and the screen prompts you to enter your master code.
- 2 Enter your master code on the keypad. If the code is correct, the safe will beep and the screen will indicate deletion of all the fingerprints.

TUTORIALS ONLINE AT VAULTEKSAFE.COM/MXSERIES-SUPPORT/

Smart Key Operation

Your Vaultek® safe supports quick access with the included Smart Key. **Take caution when using this feature and be responsible. Security can be compromised in the event the Smart Key is lost or stolen. Only pair the Smart Key after thoroughly understanding the inherent risks.**

IMPORTANT

Before you can pair the Smart Key to your safe connect the pre-installed battery by removing the pull tab from the side of Smart Key (Figure H).

Smart Key Pairing

Note: As a security measure to prevent accidental access, you must press both sides of the key simultaneously to activate referred to as a dual press. This dual press is required for the pairing process as well as anytime the Smart Key is used to open the safe. Following this procedure will pair the Smart Key to your safe.

- 1 Press and hold the '5' key then "PROGRAM" button together (3 seconds) until the LED flashes RED and the screen indicates connecting.
- 2 Aim the key towards the safe and press both sides of the key together (Figure I). If the safe beeps and the screen indicates complete then the Smart Key has paired successfully; if the screen indicates failed to pair then simply start over with step one.
- 3 **Enable Smart Key:** After pairing the Smart Key will be immediately active to test functionality and then turn off. Smart Key will need to be set to either On Demand or Progressive mode in order for Smart Key to open your safe. See page 16 for more information.

IMPORTANT Smart Key functions in close proximity to safe and has a short range of approximately 5 feet (Figure I).

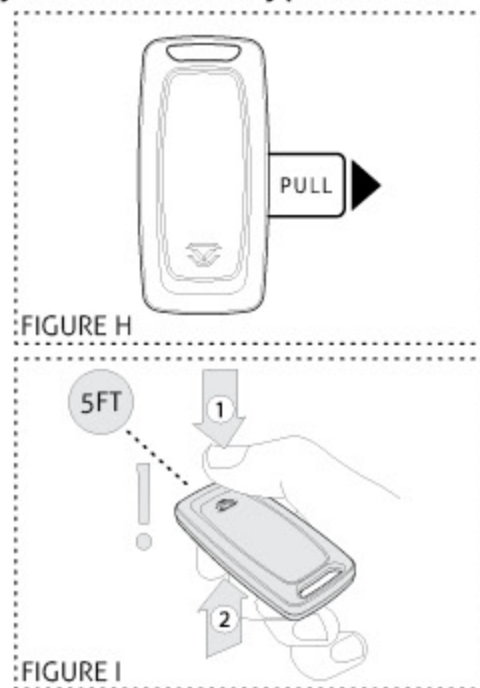

Continue on next page for more information about the Smart Key.

Toggle Smart Key Entry Modes

After pairing you can toggle between access modes from the keypad or Bluetooth app. To toggle from the keypad press and hold the '6' key then "PROGRAM" button together. The LCD screen will communicate as directed below.

OFF

Progressive Entry Mode

Safe goes into sleep mode and will require you to wake up the safe before using Smart Key. You can wake up the safe by pressing any key or brushing your hand across the keypad of the safe (backlit keys will turn RED).

On Demand Entry Mode

This mode grants immediate access to your safe without having to wake it up.



Warning: On Demand Entry Mode can open a safe in another room and/or out of sight. To reduce risk of an unattended open safe we recommend using Progressive Entry Mode.

On Demand Entry Mode requires significant power usage and can greatly reduce operation time. We suggest setting the Smart Key to Progressive Entry Mode to conserve battery.

To Unpair Smart Key

NOTE: Disabling the Smart Key function from the app or keypad will NOT delete a paired key from the safe's memory. In the event a Smart Key is lost or stolen, you can delete the lost key from the safe's memory by using a couple different methods:

- A Press and hold '5' key then "PROGRAM" button together (3 seconds) until the LED flashes RED and the screen indicates connecting. This is the same sequence used when initially pairing. After the screen indicates failed to pair the safe will delete a paired Smart Key from memory.
- B Anytime a new Smart Key is paired with the safe, the previous key will be erased from the safe's memory.

Smart Key Operation

Multiple Safe Management

- A Multiple Smart Keys can not pair with the same safe. It is recommended to pair one Smart Key per safe.
- B Recommended setting when using the Smart Key is Progressive entry mode.
- C You can manage multiple safes through the Vaultek® smartphone app.

CAUTION when managing multiple safes in On Demand Entry Mode there is a chance you can open all safes within range.

Battery Replacement

The pre-installed battery will last approximately two years before requiring replacement. When needed follow the steps below to complete replacement.

- 1 Carefully separate the remote body with a small coin or your hand starting near the top of the Smart Key at the designated coin slot.
- 2 Remove old battery and install a new model CR2032 battery (Figure J).
- 3 Assemble Smart Key back together.

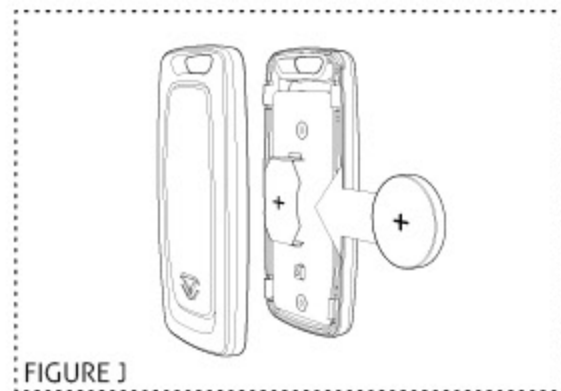

Smart Key Warnings

Take caution when using this feature and be responsible. Security can be compromised in the event Smart Key is lost or stolen. Only pair Smart Key after thoroughly understanding the inherent risks.

WARNING anyone including children can access the safe via Smart Key.

ALWAYS unpair the Smart Key in the event it is lost or stolen.

WARNING On Demand Entry Mode can open a safe in another room and/or out of sight. To reduce risk of an unattended open safe we recommend using Progressive Entry Mode.

IMPORTANT On Demand Entry Mode requires significant power usage and can greatly reduce operation time on a single charge. We suggest keeping the safe in Progressive Entry Mode. If using On Demand Entry Mode try keeping the safe plugged in.

Hot Keys More Hot Keys on the next page.

Tamper Detection

Press and hold '2' and '4'

To check for tampering press and hold keys '2' and '4' together for 3 seconds. The screen will indicate TAMPERING or CLEARED. You can reset the tamper detection by opening the safe through one of the authorized entry points.

Toggle Stealth Mode

Press and hold '1' and '3'

To toggle the sound ON/OFF press and hold keys '1' and '3' together for 3 seconds. The screen will indicate the sound is ON and beep or the screen will indicate OFF and not beep.

Toggle Travel Mode

Press and hold '1' and '8'

Save battery life by disabling the proximity sensor, fingerprint sensor, keypad, status bar, and Bluetooth features. To toggle travel mode ON/OFF press and hold keys '1' and '8' together for 3 seconds. The screen will indicate ENABLED or DISABLED.

Hot Keys

View Battery Status

Press and hold '6' and '8'

To check the battery level press and hold keys '6' and '8' together for 3 seconds. The screen will indicate the battery level. See pages 08 to 09 for more information.

Delete Fingerprints

Press and hold '3' then "PROGRAM" button then enter master code

To delete fingerprints press and hold the '3' key then "PROGRAM" button together until the safe beeps and the screen prompts you to enter your master code. Enter your master code on the keypad. If the code is correct, the safe will beep and the screen will indicate deletion of all the fingerprints. This will remove all the fingerprints. You can delete individual fingerprints in the Vaultek® app.

Toggle Interior Light

Press and hold '5' and '7'

To toggle the interior light ON/OFF press and hold keys '5' and '7' together for 3 seconds. With the light toggled to ON you can press the "LIGHT" button inside the safe to illuminate the light and can also adjust brightness in the app. If the light is toggled OFF the light will be disabled.

Toggle LCD Brightness

Press and hold '5' and '8'

The LCD screen has four brightness levels: 25%, 50%, 75%, and 100%. To toggle the LCD brightness press and hold '5' and '8' together for 3 seconds. The screen will indicate the brightness level.

Toggle Bluetooth

Press and hold '4' then "PROGRAM" button

To toggle the Bluetooth ON/OFF press and hold the '4' key then "PROGRAM" button together for 3 seconds. The screen will indicate ENABLED or DISABLED. If Bluetooth is toggled OFF all app functions will be disabled and your safe is undiscoverable.

Toggle Open Door Alarm

Press and hold '3' and '5' then "PROGRAM" button

Your safe features an open door alarm that will sound when the safe door is left open for more than 8 minutes. By default, this alarm is ON. To toggle off press and hold keys '3' and '5' and PROGRAM together (3 seconds). The screen will indicate ON or OFF.

Toggle Smart Key

Press and hold '6' then "PROGRAM" button

The Smart Key has THREE modes: OFF, Progressive Entry Mode, and On Demand Entry Mode. **OFF** disables Smart Key access. **Progressive Entry Mode** requires that you press one key on the safe keypad first and then activate the Smart Key. **On Demand Entry Mode** grants immediate access when activating the Smart Key. Pressing and holding the '6' key then "PROGRAM" button together for 3 seconds will allow you to toggle through each mode from the keypad. You may also alternate modes in the Vaultek® app.

Toggle DMT

Press and hold '7' then "PROGRAM" button

Your Vaultek® safe has a built-in accelerometer and corresponding alarm that alerts of any attacking to your safe including bumps and impacts, DMT (**Impact Detection**). DMT is enabled by default and its sensitivity has three settings; Low, Medium, and High. You can toggle through these settings by pressing and holding the '7' key then "PROGRAM" button together for 3 seconds. The screen will indicate LOW, MEDIUM, and HIGH as well as DISABLED.

Toggle Dual Entry Mode

Press and hold '8' then "PROGRAM" button

To toggle the Dual Entry ON/OFF press and hold the '8' key then "PROGRAM" button together for 3 seconds. The screen will indicate ENABLED or DISABLED. If the Dual Entry is toggled ON, you will be required to enter your master code and fingerprint (and vice versa) to open the safe. This mode requires that at least one fingerprint be programmed in the safe.

Toggle Alert of Manual Unlock

Press and hold '3' and '6' then "PROGRAM" button

If Alert of Manual Unlock is on, and someone opens the safe with either the key or by picking the lock, the keypad will start flashing. To toggle Alert of Manual Unlock press and hold keys '3' and '6' then "PROGRAM" button together for 3 seconds. The keypad will flash GREEN indicating enabled or RED indicating disabled. If ON and activated it can only be cleared by entering master code. Default is OFF.

Vaultek® App Features

The Vaultek® app lets you get the most out of your safe. Using the app gives you access and control over features that are not possible using the keypad interface alone. To get started, download and install the Vaultek® Bluetooth app for free from the Google Play store or Apple store, and pair your phone with your safe.

App Features

Unlock Safe Within Range (Optional) | Check Battery Levels | Toggle Sound On/Off

Adjust Interior Light | Manage Fingerprint IDs | View History Log

Toggle Impact Detection | Toggle Smart Key Modes | Toggle Dual Entry Mode

Helpful TIPS

History Log Timestamp Any actions recorded in the history log before your phone is paired with the safe will show a timestamp from the safe's default clock - this may not match your phone's time or date. To sync your phone's time with the safe's history log, simply remove the battery and reinstall and immediately re-sync your phone before performing any other actions.

Remote Unlock By default, the unlock feature on your app will be disabled. If you wish to enable this feature, press and hold keys '1' and '4' followed by the PROGRAM button together for 3 seconds. Repeat the sequence to disable the unlock feature.

Privacy Notice

Vaultek Safe, Inc. does not access your personal information. The app may require some permissions to store personal preferences such as your safe's settings, fingerprint ID names, and Bluetooth settings to communicate with your safe. In no way do we gain or collect any personal information from you.

Vaultek® App Pairing

- 1 Get the App** Download the Vaultek® Bluetooth app from the Google Play store or Apple store.
- 2 Make sure your phone's Bluetooth settings are set to ON, and open the Vaultek® Bluetooth app to begin.**
IMPORTANT You must be within Bluetooth range to pair your phone with your safe. The approximate range is 25 feet.
- 3 Create a Pattern Lock** This is an added layer of protection to safeguard your safe and prevent unauthorized access in the event your phone is misplaced. To create your pattern lock, simply drag your finger along the screen to connect at least four dots. This unique pattern will be required each time you open the app.
- 4 Select Your Safe** After a few seconds your safe will appear in the search. You can drag the screen downwards to refresh if you are not seeing your safe listed. Select your safe, and enter your safe's master code when prompted. This is the same code used to open the safe using the numeric keypad.

IMPORTANT If you change your safe's master code after pairing, the safe will no longer connect to your app, and you will be prompted to enter the new code when needed.

IMPORTANT As a security measure, if too many incorrect master code entries are entered, your safe's Bluetooth will disable and must be toggled ON again using the hot key sequence.

- 5 Sync Your Phone** Press and hold keys '4' and '5' on your safe followed by the PROGRAM button together for 3 seconds to start the syncing protocol. When the keypad starts blinking red you can finalize the pairing sequence from your app screen by pressing 'OK'. The safe's keypad will flash green and beep when complete, if the keypad flashes red with two beeps you will need start over with step 4.

TIP This pairing sequence offers enhanced security protection and can only be used to pair one phone to your safe. If the process is repeated with a different phone, the previous phone will be overridden and disconnected from the safe.

Remote Unlock Refer to page 21 on how to enable this feature.

Securing Your Safe

Your Vaultek® safe can be secured via the included mounting screws to a flat surface using the pre-drilled holes on the bottom and back of the safe.

TIP: Make sure you have enough clearance for the door to open properly before mounting the safe.

- 1 Position the safe on a flat surface where you want to mount it.
- 2 Use a pencil to mark the holes for drilling.

TIP: Remove the covers to access bottom mounting holes.

- 3 Remove safe and drill pilot holes.
- 4 Position safe in place and install screws through safe into pilot holes. Tighten screws.

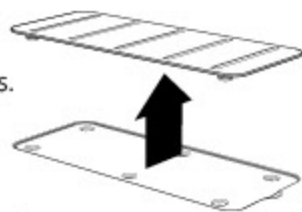

Modular Interior

Your MX Series safe features a customizable interior system with a height adjustable pull out shelf and drop in modules to help with storage and organization.

Adjust Interior Shelf Height

- 1 Lift the shelf vertically to remove from mounting brackets.
- 2 Remove the screw/mounting brackets from the sidewalls and reinstall at the desired height.
- 3 Place shelf back onto the mounting brackets and press down firmly to install.

Drop In Modules

A twin pistol rack is included and can be placed wherever there is an insert cover. Remove the covers to access the slots to attach each module, and snap into place. A range of different modules are available for purchase.

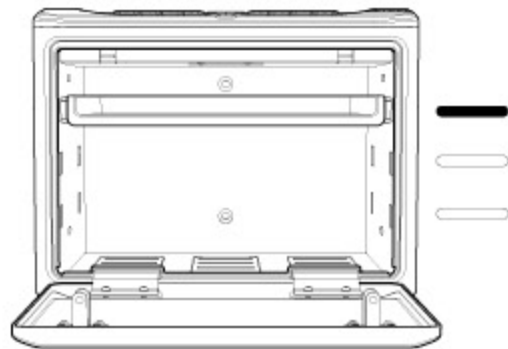

Product Registration

Vaultek® strongly encourages you to register your safe as soon as you receive it. **Registration provides many benefits including three year warranty, technical support, and ordering replacement keys should you misplace them.** Your Vaultek® safe has a unique product number on the inside of the battery door and a 4-digit ID number engraved on the keys. You will need these numbers to register your safe.

- 1 Locate your product number. It is printed on the first page of this user manual and on the back of the battery door (Figure K/L).
- 2 Find your 4-digit ID number engraved on the keys (Figure M).
- 3 Please visit the Vaultek® website at vaulteksafe.com and click Support/Product Registration.
- 4 Enter the required information in the form and click submit.

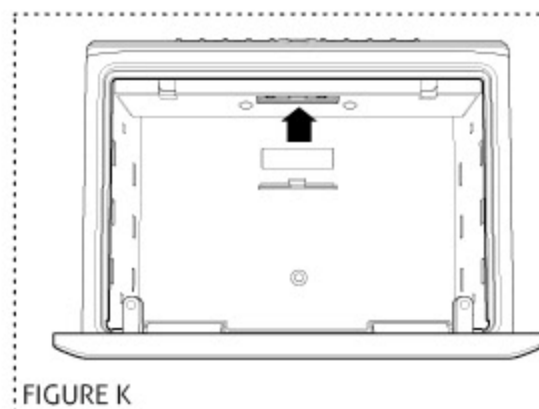

FIGURE K

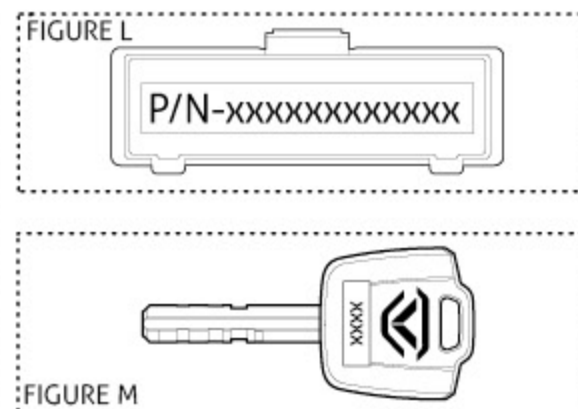

FIGURE L

FIGURE M

TUTORIALS ONLINE AT VAULTEKSAFE.COM/MXSERIES-SUPPORT/

Bluetooth App

Q: What code is the Vaultek® app asking for pairing?

A: That is the master code used to open the safe via the numeric keypad. Refer to page 22.

Q: Why is the unlock button grayed out?

A: By default, the unlock feature on your app will be disabled. If you wish to enable this feature, press and hold keys '1' and '4' followed by the PROGRAM button together for 3 seconds. Repeat the sequence to disable the unlock feature.

Battery

Q: Can I keep the safe plugged in at all times?

A: Leaving your safe plugged in continually will **not** harm the safe or battery. However, to preserve the battery life span for portability we suggest that you unplug occasionally to allow the battery to cycle down.

Q: What happens to the fingerprints that are stored in my Vaultek® safe when the battery dies? (MXi Only)

A: The safe retains all fingerprints in the even of battery failure. Once the power is restored by inserting the AC adapter cable, the unit will function as it did before the power loss.

Q: What type of battery does my Vaultek® safe use?

A: Use a 3.7V 18650 rechargeable lithium-ion battery with a flat top. A minimum 2000 mAh capacity is required, however 2200 mAh or higher can be used to increase operation time. This type battery is commonly available and in the event you do not seek Vaultek® for a replacement we recommend a brand name like Panasonic.

Q: Can I use a battery of more than 2000 mAh?

A: Yes, a minimum 2000mAh capacity is required, however 2200 mAh or higher can be used to increase operation time. An upgrade battery is available through Vaultek®.

Fingerprint Scanner (MXi Only)

Q: How do I improve fingerprint success rate?

A: Refer to page 11 for tips.

Q: If I cut my finger, does the fingerprint heal the same as before and will it open my safe?

A: Usually yes, although if the cut is significant or requires stitches scar tissue may form as a result causing a change in your fingerprint. That is why we recommend enrolling additional user fingerprints and also fingerprints from your other hand.

Q: Will my Vaultek® safe scan my finger correctly when my finger/fingerprint is wrinkled after bathing or swimming?

A: The Vaultek® safe has been designed to be very sensitive when authenticating and matching fingerprints. The unit will open when your fingerprint has increased moisture from an average shower or swim. However, extreme water retention due to extended time in the water will cause aspects of your fingerprint to change for a short period. If this happens, fingerprint access to your safe may be denied until your fingerprint returns to its normal condition. The keypad and app will not be affected and will still function normally to open the safe.

Keys

Q: What happens if I lose the keys?

A: First, make sure you registered your safe in the event you do lose your keys. Visit Support at vaulteksafe.com for assistance in replacing a set of keys. Be prepared to provide your order details and product number.

Models

Q: What other models are available?

A: Refer to our website to see all the available models. Also, feel free to sign up for our newsletter to receive the latest news on all things Vaultek®.

Traveling

Q: Can I travel with my Vaultek® safe through US Customs or TSA Security at the airport?

A: Yes, there are no restrictions on carrying this type of item. Please be aware that you may be asked to open your safe. Rather than passing it through x-ray, and we recommend that an enrolled user be present during the transport of this item in case such a request is made by a government authority. If transporting a firearm, be sure the safe is checked or included with checked luggage and that you notify your airline agent at check in.

If you experience any issues with your safe, try the following solutions.

The app history clock data does not match up with my phone's clock.

A: Refer to page 21 on History Log Timestamp.

The unlock feature on the app is grayed out.

A: By default, the unlock feature on your app will be disabled. If you wish to enable this feature, press and hold keys '1' and '4' followed by the PROGRAM button together for 3 seconds. Repeat the sequence to disable the unlock feature.

Smart Key is not working.

A: After pairing you need to assign an entry mode. Refer to Step 3 on page 15. After Smart Key is paired you need to assign to either On Demand or Progressive entry mode, otherwise Smart Key will disable after pairing.

Fingerprint scanner works sometimes and not others.

A: We have a few suggestions to help improve the success rate on page 11.

The keypad is not responding

A: Remove the battery and reinstall. This is a soft reset for the safe. See if you are able to open the safe using the keypad or reprogram the safe's master code. If you are still experiencing issues please visit Support at vaulteksafe.com for assistance.

Door is not engaging.

A: The door requires a firm press. You will feel the latches engage if you press slowly. Feel/listen for the click.

Sound is not working.

A: To toggle the sound ON/OFF press and hold keys '1' and '3' together for 3 seconds. The screen will indicate the sound is ON and beep or the screen will indicate OFF and not beep. If the sound is toggled on and you still can't hear it, have someone in your house listen.

Unable to change master code.

A: Refer to page 10 of the user manual or check our tutorials online at vaulteksafe.com/mxseries-support/.

Soft Reset: Remove the battery and reinstall. This is a soft reset to the safe. Refer to page 09 for more details.

STOP! Do not return to retailer. If you have any questions about your Vaultek® safe or need help configuring the system, please visit Support at vaulteksafe.com.

Customer Support

If you have a problem with your Vaultek® safe that is not answered in the FAQ section of this manual, we encourage you to visit www.vaulteksafe.com/mxseries-support/.

Limited Warranty (Terms and Conditions)

VAULTEK® IS COMMITTED TO PROVIDING PRODUCTS OF HIGH QUALITY AND VALUE AND MAKES EVERY EFFORT TO ENSURE ITS PRODUCTS ARE FREE OF DEFECTS.

Vaultek® guarantees your safe will be free of defects in materials or workmanship for a period of two years from the date of original purchase from an authorized dealer and three years with verified product registration.

The warranty is only valid for the original purchaser and not transferable. This warranty is only valid for products purchased and operated in the U.S. This warranty does not cover abuse, misuse, use in any manner for which is not designed, neglected, modification, damage inadvertently caused by the user, accidents and/or tampering.

If service is needed Vaultek will, at its option, exchange or repair without charge for parts or labor. Upon authorization of warranty service, customers are responsible for securely packaging product. Additionally, customers are responsible for costs of shipping to and from Vaultek service center.

If the claimed defect cannot be identified or reproduced, customers will be held responsible for the costs incurred. Please have the following information available before you begin a claim with Vaultek:

- Purchaser's name, mailing address, email address, and a phone number.
- Copy of receipt or online order number (if purchased directly from us or Amazon)
- Authorized Dealer Name (if applicable)
- Detailed description of the problem

NEITHER SELLER NOR MANUFACTURER SHALL BE LIABLE FOR ANY INJURY, LOSS OR DAMAGE, DIRECT OR CONSEQUENTIAL, ARISING OUT OF THE USE OF, OR THE INABILITY TO USE THE VAULTEK® SAFE.

This device has been evaluated to meet general RF exposure requirement, and this device can be used in portable exposure condition without restriction.

FCC statements:

This device complies with part 15 of the FCC rules. Operation is subject to the following two conditions: (1) this device may not cause harmful interference, and (2) this device must accept any interference received, including interference that may cause undesired operation.

NOTE: The manufacturer is not responsible for any radio or TV interference caused by unauthorized modifications or changes to this equipment. Such modifications or changes could void the user's authority to operate the equipment.

NOTE: This equipment has been tested and found to comply with the limits for a Class B digital device, pursuant to part 15 of the FCC Rules. These limits are designed to provide reasonable protection against harmful interference in a residential installation. This equipment generates uses and can radiate radio frequency energy and, if not installed and used in accordance with the instructions, may cause harmful interference to radio communications. However, there is no guarantee that interference will not occur in a particular installation. If this equipment does cause harmful interference to radio or television reception, which can be determined by turning the equipment off and on, the user is encouraged to try to correct the interference by one or more of the following measures:

- Reorient or relocate the receiving antenna.
- Increase the separation between the equipment and receiver.
- Connect the equipment into an outlet on a circuit different from that to which the receiver is connected.
- Consult the dealer or an experienced radio/TV technician for help.



VAULTEK®

37 North Orange Ave. Suite 800B Orlando, FL 32801

VAULTEKSAFE.COM