

TCL Series Troubleshooting Guide

TCL Series 120-277VAC

Last Update: 07/16/20

Identify the Sign Problem:

Follow the flowchart to diagnose the symptoms

There are some LEDs out

Pg 2

A message is lit that shouldn't be

Pg 3

The display is flickering

Pg 4

The entire display is out

Pg 5

Tools Needed:

Philips head screwdriver
Multi-meter

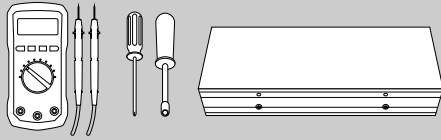

Always turn off the power to the sign prior to opening the cabinet. Disconnect the power wires going to the sign.

Note: Clear all metal chips created by drilling into sign cabinet.

Note: Do not over-tighten fasteners or distort back panel.

Note: Make appropriate wiring connections per local codes.

Description of Normal Operation for the Sign's Internal Power Supply

Diagnostic LEDs are included on the internal power supply to aid in verifying that input power is present and is being transferred to the sign face through the output connectors.

+12V LED

This LED illuminates Green when 120-277VAC power is applied to the internal power supply's input power pigtail.

Note: The transformer on the power supply converts 120-277VAC power to +12V.

A Output LED

Illuminates with power applied to Black/White stripe wire on the input power pigtail

B Output LED

Illuminates with power applied to Black/Yellow stripe wire on the input power pigtail

C Output LED

Illuminates with power applied to Black/Red stripe wire on the input power pigtail

Output Connectors

These connectors transfer power from the internal power supply to the sign face to illuminate the individual message(s).

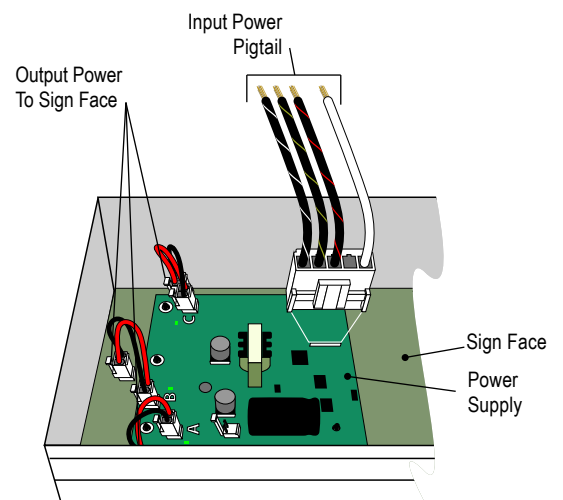
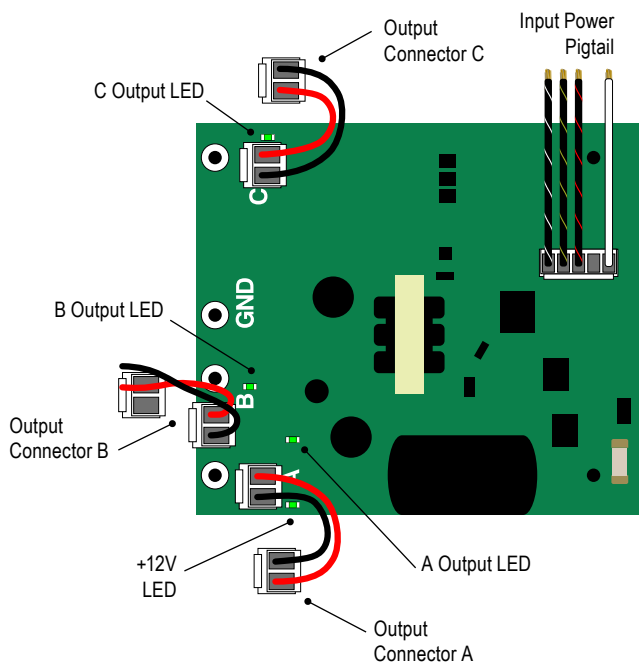

Problem: There are some LEDs out

TCL Series 120-277VAC

Last Update: 07/16/20

Please refer to the diagrams on page 1.

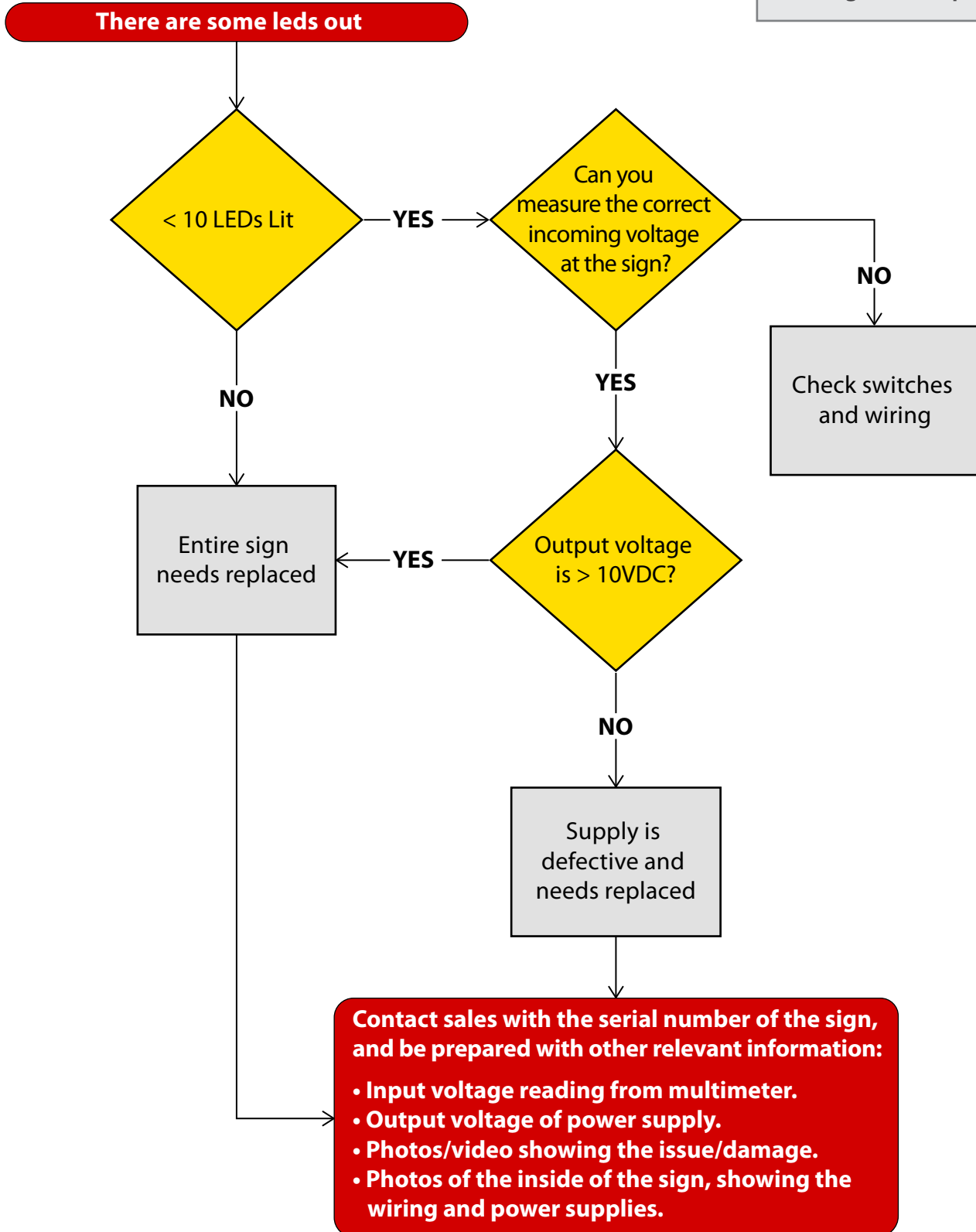

Problem: A message is lit that shouldn't be

TCL Series 120-277VAC

Last Update: 07/16/20

Please refer to the diagrams on page 1.

A message is lit that should not be

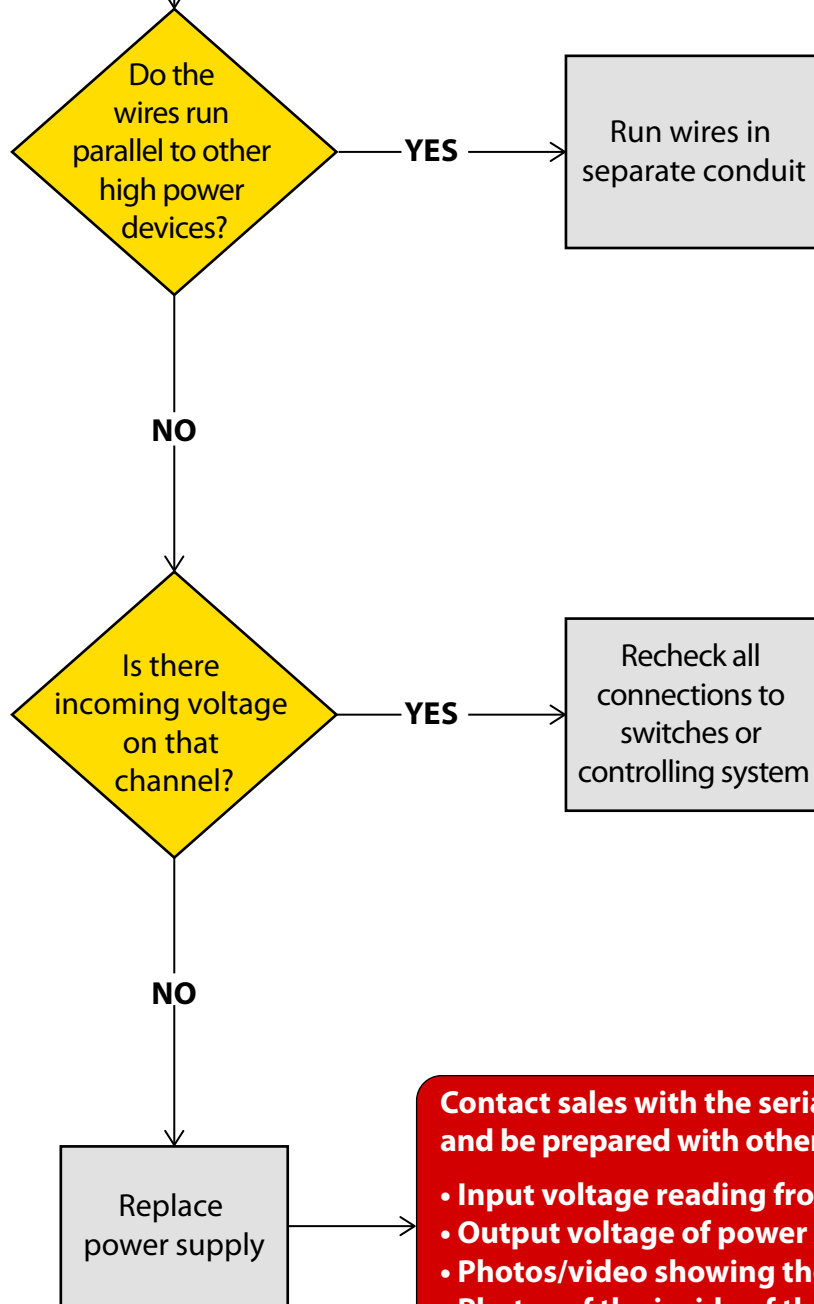

Contact sales with the serial number of the sign, and be prepared with other relevant information:

- Input voltage reading from multimeter.
- Output voltage of power supply.
- Photos/video showing the issue/damage.
- Photos of the inside of the sign, showing the wiring and power supplies.

Problem: Display is flickering

TCL Series 120-277VAC

Last Update: 07/16/20

Please refer to the diagrams on page 1.

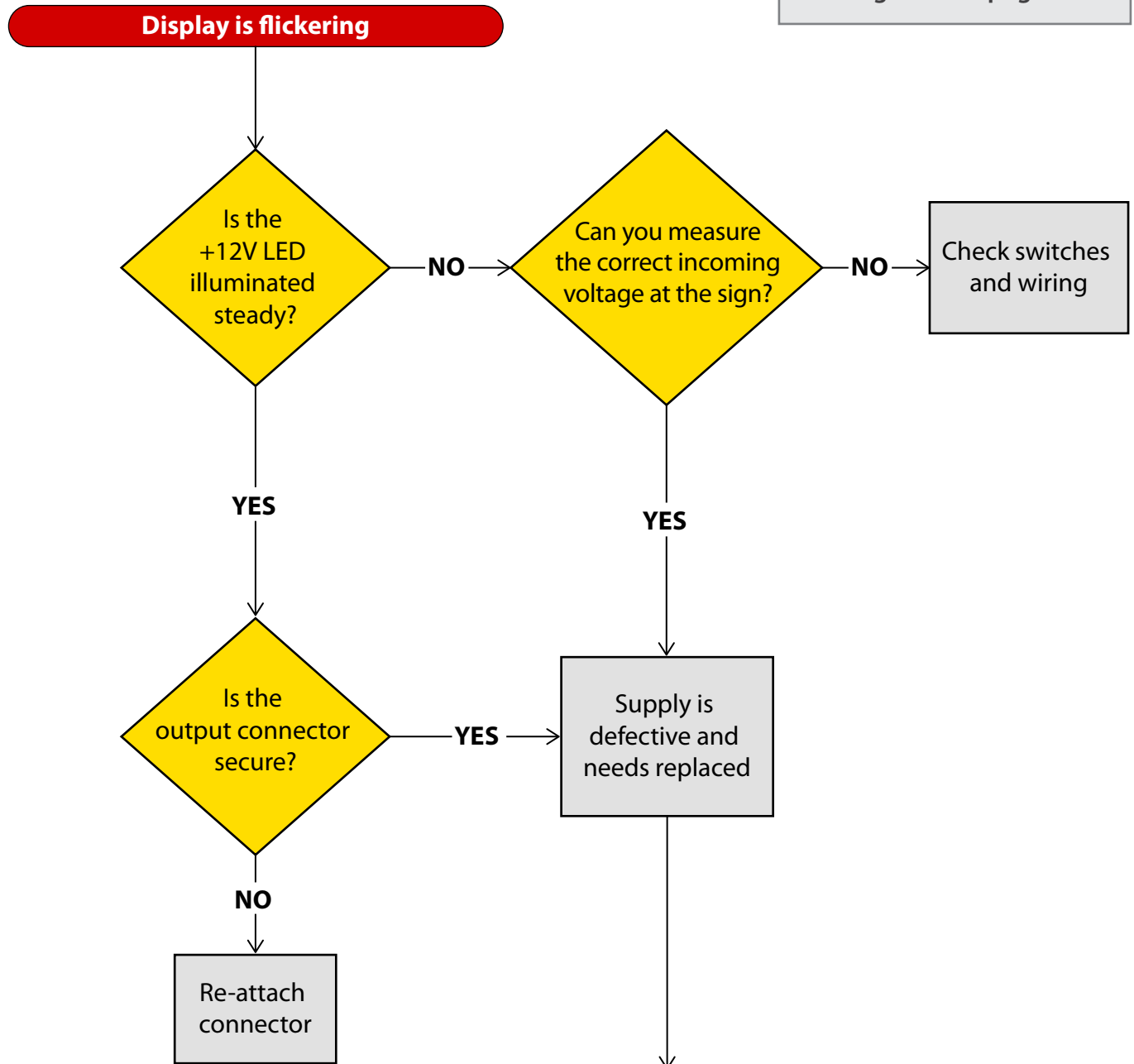

Contact sales with the serial number of the sign, and be prepared with other relevant information:

- Input voltage reading from multimeter.
- Output voltage of power supply.
- Photos/video showing the issue/damage.
- Photos of the inside of the sign, showing the wiring and power supplies.

Problem: Entire display is out

TCL Series 120-277VAC

Last Update: 07/16/20

Please refer to the diagrams on page 1.

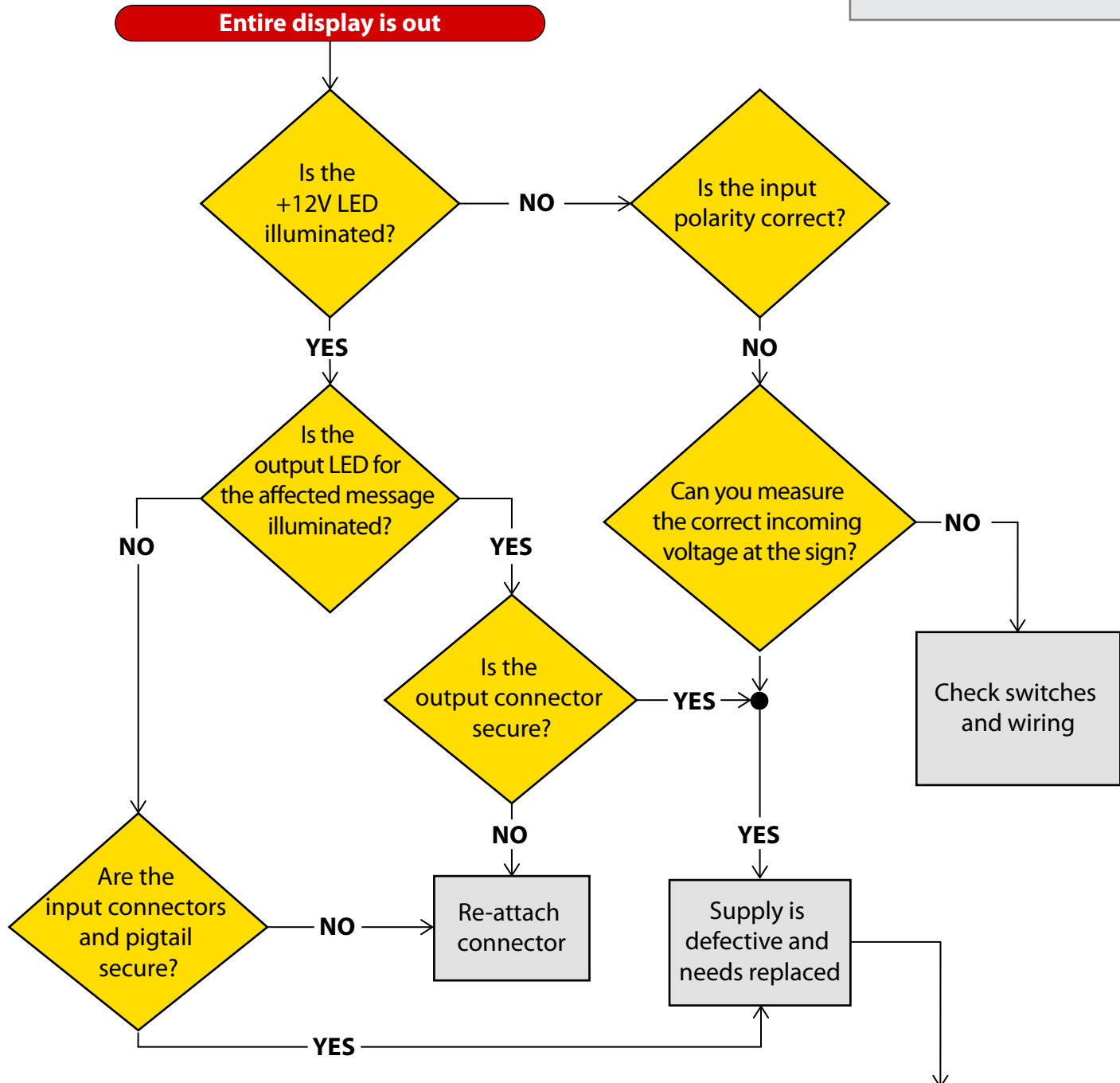

Contact sales with the serial number of the sign, and be prepared with other relevant information:

- Input voltage reading from multimeter.
- Output voltage of power supply.
- Photos/video showing the issue/damage.
- Photos of the inside of the sign, showing the wiring and power supplies.