



SCHLAGE

# ND Series

Cylindrical locks





## Contents

4-5	Mechanical lock guide
6-7	ND Series introduction
8	Performance features
9	Exploded view
10	Lever designs
11	Lever finishes
11	Door handing
12-15	Lock functions
16	ND Series electrified locks and wiring diagram
17	Cylinders and key systems
18	Standard cylinders
18	Full size interchangeable core
18	Primus XP high security cylinders
19	Small format interchangeable core
20	Latches
21	Strikes
21	Rabbeted latch and strike kit
21	Accessories
22	Specifications and certifications

Pictured here: Tubular lever shown in 626 satin chrome

Cover photo: Omega lever shown in 626 satin chrome

Be sure to ask your SSC representative to tell you about **Custom Solutions** by Allegion.  
To learn more visit [allegion.com](http://allegion.com).



**Quiet**Solutions



**Custom**Décor



**High**Security and Safety



**Environmental**Solutions



**Flexible**Configurations

# Put your trust in the name you know

For more than 90 years, Schlage® has been creating the strongest and most technologically advanced security products for schools, hospitals, hotels, commercial and institutional buildings, multi-family properties and homes. From durable mechanical locks to comprehensive electronic access control solutions and biometrics, Schlage provides protection at critical moments – when property and personal security are at stake. With a wide range of products, styles and finishes, Schlage has products for the most demanding project specifications. In public buildings, in the workplace, and in homes, at the end of the day Schlage stands for one thing: strong.



**Tubular interconnected locks**



**Tubular locks**



**Tubular interconnected locks**



**Cylindrical locks**







**Cylindrical interconnected locks**

CS200 Series	S Series	S200 Series	A Series	H Series
Grade 2	Grade 2		Grade 2	
<b>Security level:</b>				
ANSI/BHMA certified A156.12-2013 Exceeds 400,000 ANSI cycles Medium traffic	ANSI/BHMA certified A156.2-2011 Exceeds 400,000 ANSI cycles Light traffic	- - Exceeds 400,000 ANSI cycles Medium traffic	ANSI/BHMA certified A156.2-2011 Exceeds 400,000 ANSI cycles Medium traffic	- - Exceeds 400,000 ANSI cycles Medium traffic
<b>Typical applications:</b>				
Exterior Interior New construction Retrofit	- Interior - Retrofit	Exterior Interior New construction Retrofit	Exterior Interior New construction Retrofit	Exterior Interior - Retrofit
<b>Functions available:</b>				
1 Function - -	6 Functions - -	5 Functions - -	11 Functions - -	5 Functions - -
<b>Design options:</b>				
7 Finishes 15 Lever styles - 1 Matching rose 2 Interior escutcheons Tactile warning available	7 Finishes 4 Lever styles - 1 Matching rose - Tactile warning available	7 Finishes 4 Lever styles - 1 Matching rose 1 Interior escutcheon -	10 Finishes 1 Lever style 4 Knob styles 1 Matching rose - -	7 Finishes 1 Lever style 2 Knob styles 1 Matching rose 1 Interior escutcheon -
<b>Often used in:</b>				
Commercial Multi-family Office	Commercial Multi-family Office	Commercial Multi-family Office	Commercial Govt/military Healthcare Hospitality Office Retail	Commercial Govt/military Multi-family

Not all functions and finishes available with all products. Please consult your SSC representative for details.



				
<b>Cylindrical locks</b>	<b>Deadbolts</b>	<b>Cylindrical locks</b>	<b>Cylindrical locks</b>	<b>Mortise locks</b>
<b>AL Series</b>	<b>B Series</b>	<b>D Series</b>	<b>ND Series</b>	<b>L Series</b>
<b>Grade 2</b>	<b>Grade 2</b>	<b>Grade 1</b>	<b>Grade 1</b>	<b>Grade 1</b>
<b>Security level:</b>				
ANSI/BHMA certified A156.2-2011 Exceeds 400,000 ANSI cycles Medium traffic	ANSI/BHMA certified A156.36-2010 Exceeds 150,000/250,000 ANSI cycles High traffic, heavy-duty	ANSI/BHMA certified A156.2-2011 Exceeds 1,000,000 ANSI cycles High traffic	ANSI/BHMA certified A156.2-2011 Exceeds 1,000,000 ANSI cycles Heavy-duty traffic	ANSI/BHMA certified A156.13-2012 Exceeds 1,000,000 ANSI cycles Heavy-duty traffic
<b>Typical applications:</b>				
Exterior Interior New construction Retrofit	Exterior - New construction Retrofit	Exterior Interior - Retrofit	Exterior Interior New construction Retrofit	Exterior Interior New construction Retrofit
<b>Functions available:</b>				
10 Functions - -	7 Functions - -	6 Functions - -	14 Functions 2 Electrified -	29 Functions 6 Electrified Vandgard® available
<b>Design options:</b>				
10 Finishes 4 Lever styles - 1 Matching rose - Tactile warning available	10 Finishes - - - - Indicator rose	10 Finishes - 3 Knob styles 1 Matching rose - -	9 Finishes 5 Lever styles - 2 Matching roses - Tactile warning available	13 Finishes 32 Lever style 3 Knob styles 5 Matching roses 2 Escutcheons Tactile warning available Antiligature available
<b>Often used in:</b>				
Commercial Healthcare Hospitality Office Retail	Commercial/institutional Govt/military Heavy-duty residential Hospitality Office Retail	Institutional Govt/military Hospitality Retail	Institutional Education Healthcare Office Retail	Commercial/institutional Govt/military Education Healthcare Office Retail

This chart shows the most common uses/applications. These products are often used in other applications in addition to those listed.

Rev. 04/14



# Real security is knowing exactly what you want and getting it

When you know exactly what you want, you don't want to waste time finding out whether it meets your project specifications. That's why we offer the world's largest team of hardware specification writers to help you and your clients turn your vision into reality. And when it comes to products, our commercial suiting options, wide variety of lever designs and rich selection of finishes give you the tools you need to make your projects perfect. You know what you want. With Schlage you can be sure you'll get it.

## Safety, security and confidence

When you choose a Schlage lock you can be sure you've done the job right the first time. After all, our products are among the most durable and dependable on the market today. Our locks are easy to install, and simple to repair and maintain. That means fewer callbacks for you and total safety and security for your customers.

# ND Series

Continuous improvements make the ND Series a simpler, smarter, stronger lock.

The ND Series has long been one of Schlage's best selling mechanical locks for good reason - it's tough, durable, Grade 1 rated and fits a wide variety of applications. Now we've made our trusted ND Series lock even better by making it easier to install. We've added these enhancements because we know that a lock installed correctly the first time will last longer and perform better. And the longer the lock lasts, the lower the cost of ownership over the life of the lock. We've also beefed up our warranty to provide 10 years of coverage. The result: greater peace of mind that every door is safe and secured with a lock built to last.

So not only do you get our toughest Grade 1 cylindrical lock, that is ideal for use in schools, hospitals, offices, retail spaces, colleges, universities and other applications. You also get the promise of continuous improvements and innovations and our greatest warranty backing your project.



Pictured here: Sparta lever shown in 626 satin chrome

## We don't compromise on security

The safety and security of your clients' buildings is something we take very seriously. That's why every Schlage lock and deadbolt undergoes intensive testing to determine its ANSI grade level:

- Cycle tests
- Resistance tests
- Door impact tests
- Warped door tests
- Bolt strength tests

We pay attention to these details so you can focus on creating a functional and aesthetically pleasing environment for your clients. In fact, every one of our ND Series locks meets ANSI Grade 1 standards for safety.



# ND Series

The Schlage ND Series is the toughest cylindrical lock we make. That means you get premium durability and performance in a lock that's also easy to service and maintain. And because we test our locks beyond the standards required by ANSI, you know that you're getting a product you can count on to withstand the use and abuse that come with heavy duty commercial applications.

Pictured here: Athens lever shown in 626 Satin Chrome





# Built to perform without fail

- Tested to three times the ANSI Grade 1 requirement
- Exceeds ANSI A156.2, Series 4000 Grade 1 locked lever torque requirements
- 10-year limited warranty

New chassis-to-door alignment gauge is embossed with door thickness 1<sup>3</sup>/<sub>4</sub>" and 2", taking the guesswork out of installation by providing visual and positive "stop" for door size adjustment

Anti-rotation plate

Inside spring cage assembly with integrated spindle/spring cage

Rose

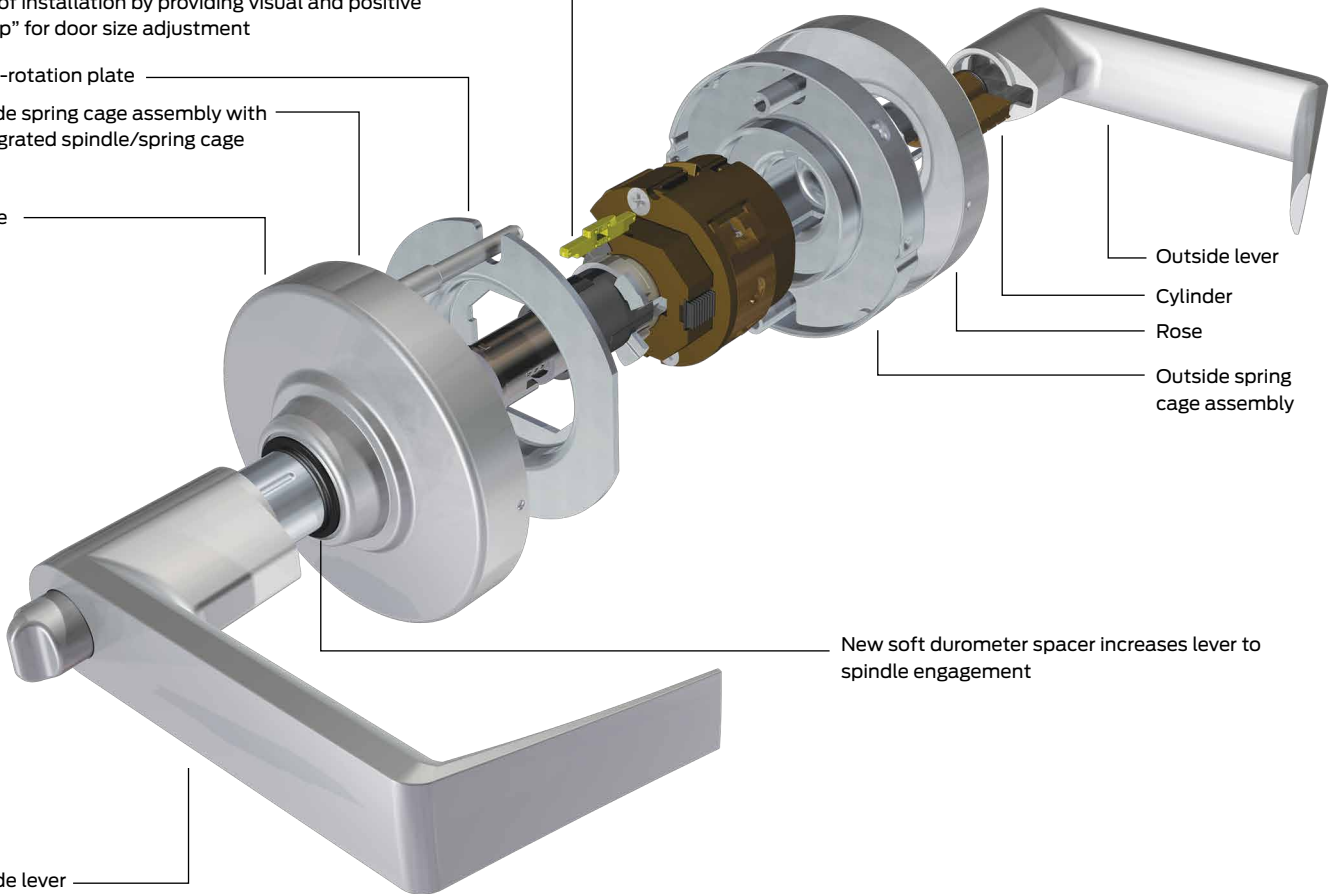

Inside lever

Outside lever  
Cylinder  
Rose  
Outside spring cage assembly

New soft durometer spacer increases lever to spindle engagement

## ND Series with Vandlgard

The ND Series Vandlgard is ideal for areas subject to abuse or anywhere vandalism is likely to be present, such as schools, universities, offices and commercial/public buildings. Vandlgard prevents damage to internal lock components caused by excessive force from hitting or standing on the lever to gain access. Vandlgard functions maintain total key system and architectural design compatibility with Schlage's regular ND Series cylindrical locks.

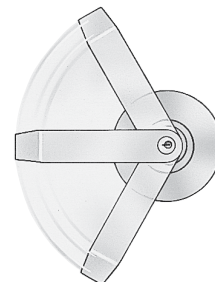

Locked lever freely rotates up and down while remaining securely locked. The Vandlgard function also increases resistance to over-rotation of the lever.

# Lever designs

## Athens (ATH)

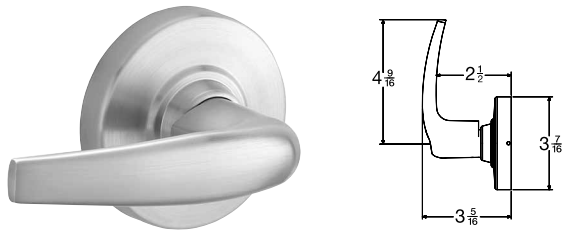

**Material:** Pressure cast zinc lever; wrought brass rose



## Sparta (SPA)



**Material:** Pressure cast zinc lever; wrought brass rose



## Rhodes (RHO)

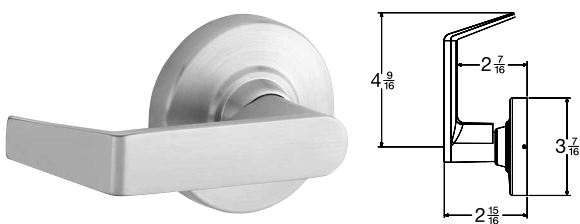

**Material:** Pressure cast zinc lever; wrought brass rose



## Tubular (TLR)



**Material:** Pressure cast zinc lever; wrought brass rose



## Omega (OME)



**Material:** Pressure cast zinc lever; wrought brass rose



### Tactile warning

#### Milled

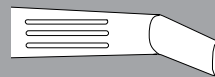

Order as follows:  
**BAT** for Athens  
**BRO** for Rhodes  
**BSP** for Sparta

#### Knurled

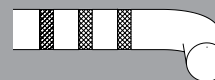









Order as follows:  
**BTR** for Tubular

Only available on outside lever, unless otherwise specified

All designs shown in 626 satin chrome

- = Standard cylinder.
- = FSIC - Full size interchangeable core option.
- = SFIC - Small format interchangeable core option.
- = Complies with ADA accessibility guidelines.
- = Antimicrobial coating available on 626 finish only.
- = Meets California code for 1/2" or less return to the door.
- = Extended factory lead time.

## Lever finishes

								
	<b>605</b> Bright brass	<b>606</b> Satin brass	<b>612</b> Satin bronze	<b>613</b> Oil rubbed bronze	<b>619</b> Satin nickel	<b>625</b> Bright chromium plated	<b>626</b> Satin chromium plated	<b>643e</b> Aged bronze
<b>ND Series locks</b>								
Athens	•	•	•	•	•	•	•	•
Omega	•	•	•	•	•	•	•	•
Rhodes	•	•	•	•	•	•	•	•
Sparta	•	•	•	•	•	•	•	•
Tubular	•	•	•	•	•	•	•	•

e = an equivalent finish to the BHMA standard.

## Door handing

All ND levers are reversible. Hand information is necessary to ensure proper cylinder orientation in keyed functions, and finish of latchbolt and strike for locks that are to be installed on reverse bevel doors. Follow the diagram to correctly determine the hand of the door.

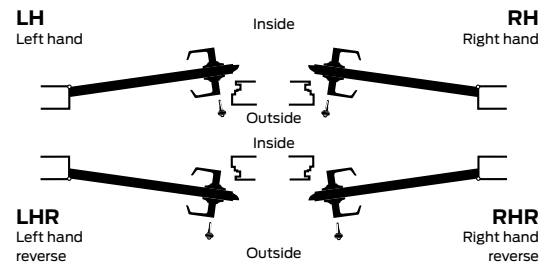

## ADA-compliant products



In compliance with the American National Standards Institute (ANSI A117.1) and the Americans with Disabilities Act (ADA), Schlage Lock Company offers a wide selection of locks designed for the needs of the physically challenged. This act is designed to provide protection for people with disabilities.

The intent of ADA is that owners of certain types of buildings must remove barriers and provide people with disabilities with access equal to, or similar to, that available to the general public.

Product information and specifications contained in this catalog are subject to change without notice. Please consult the factory.



# Lock functions

ANSI A156.2 Series 4000 Grade 1

## Non-keyed locks

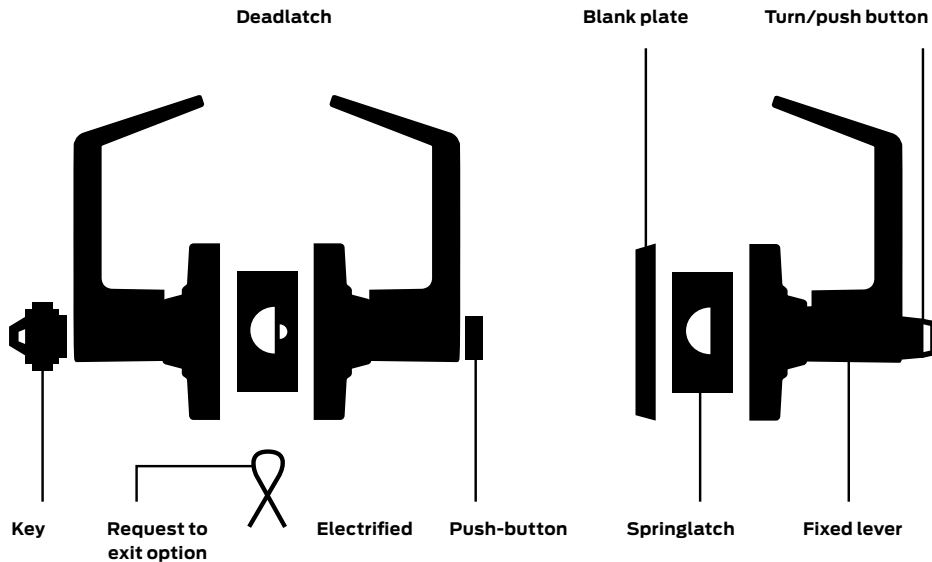

Schlage **ND10S** ANSI **F75**

### Passage latch

- Both levers always unlocked.

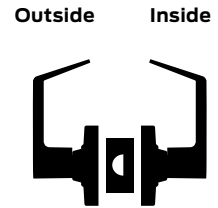

Available with RX feature

Schlage **ND12D** ANSI **F89**

### Exit lock

- Outside lever always fixed.
- Inside lever always unlocked.

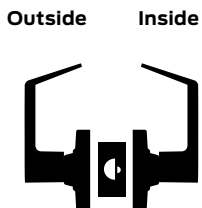

Available with RX feature

Schlage **ND12DEL** ANSI **-**

### Electrically locked (fail safe)

- Outside lever continuously locked electrically.
- Unlocked by switch or power failure.
- Auxiliary latch deadlocks latchbolt when door is closed.
- Inside lever always free for immediate exit.

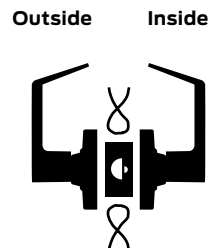

Schlage **ND12DEU** ANSI **-**

### Electrically unlocked (fail secure)

- Outside lever continuously locked until unlocked by electric current.
- Auxiliary latch deadlocks latchbolt when door is closed.
- Inside lever is always free for immediate exit.

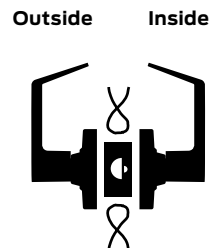

Schlage **ND25D** ANSI **-**

### Exit lock

- Blank plate outside.
- Inside lever always unlocked.

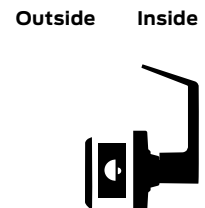

 Standard cylinder.

 FSIC - full size interchangeable core option.

 Safe school locks.

 SFIC - small format interchangeable core option.

### †Caution:

Double cylinder locks are a life safety hazard in times of emergency and their use is not recommended. Installation should be in accordance with existing codes only.

## Keyed locks

Schlage ANSI  
**ND40S F76**

### Bath/bedroom privacy lock

- Push-button locking.
- Can be opened from outside with a small screwdriver.
- Turn inside lever or close door to release button.

Outside Inside

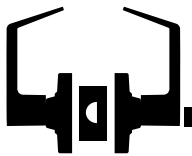

Schlage ANSI  
**ND44S -**

### Hospital privacy lock

- Push-button locking.
- Unlocked from outside by turning emergency turn-button.
- Turn inside lever or close door to release button.

Outside Inside

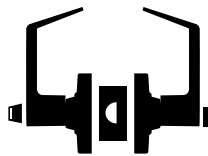

Schlage ANSI  
**ND170 -**

### Single dummy trim

- Dummy trim for one side of door.
- Used for door pull or as matching inactive trim.

Outside/Inside



Schlage ANSI  
**ND50PD F82**

### Entrance/office lock

- Push-button locking.
- Push-button locks outside lever until it is unlocked with key or by turning inside lever.

Outside Inside

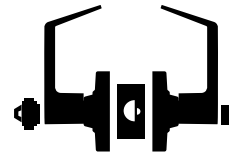

Schlage ANSI  
**ND53PD F109**

### Entrance lock

- Turn/push-button locking: Pushing and turning the button locks the outside lever, requiring use of a key until the button is manually unlocked.
- Push-button locking: Pushing button locks outside lever until unlocked by key or by turning the inside lever.

Outside Inside

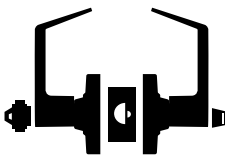

Schlage ANSI  
**ND60PD F88**

### Vestibule lock

- Latch retracted by key from outside when outside lever is locked by key in inside lever.
- Inside lever always unlocked for immediate egress.

Outside Inside

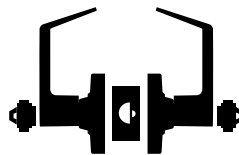

Schlage ANSI  
**ND66PD F91**

### Store lock†

- Key in either lever locks or unlocks both levers.

Outside Inside

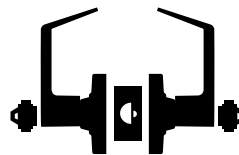

Schlage ANSI  
**ND70PD F84**

### Classroom lock

- Outside lever locked and unlocked by key.
- Inside lever always unlocked.

Outside Inside

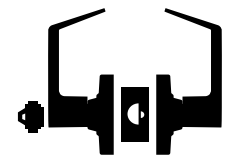

# Lock functions

## ANSI A156.2 Series 4000 Grade 1

### Keyed locks (continued)

Schlage      ANSI  
**ND73PD**      **F90**

#### Corridor lock

- Locked or unlocked by key from outside.
- Push-button locking from inside.
- Turn inside lever or close door to release button.
- When outside lever is locked by key it can only be unlocked by key.
- Inside lever is always unlocked.

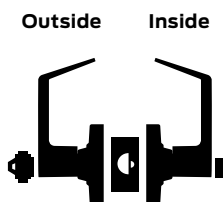

Schlage      ANSI  
**ND75PD**      -

#### Classroom security lock

- Key in either lever locks or unlocks outside lever.
- Inside lever is always unlocked.

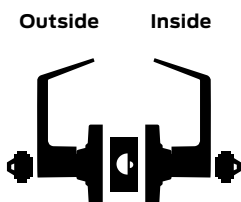

Schlage      ANSI  
**ND80PD**      **F86**

#### Storeroom lock

- Outside lever is fixed.
- Entrance by key only.
- Inside lever always unlocked.

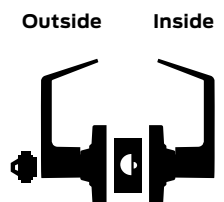

Available with RX feature



Schlage      ANSI  
**ND80PDEL**      -

#### Electrically locked (fail safe)

- Outside lever continuously locked electrically.
- Unlocked by key outside or by switch or power failure.
- Auxiliary latch deadlocks latchbolt when door is closed.
- Inside lever always free for immediate exit.

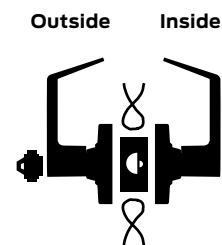

Schlage      ANSI  
**ND80PDEU**      -

#### Electrically unlocked (fail secure)

- Outside lever continuously locked until unlocked by key or electric current.
- Auxiliary latch deadlocks latchbolt when door is closed.
- Inside lever always free for immediate exit.

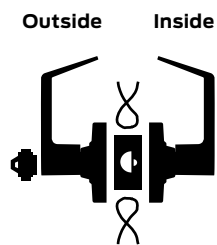

Schlage      ANSI  
**ND82PD**      **F87**

#### Institution lock†

- Both levers are fixed.
- Entrance by key in either lever.

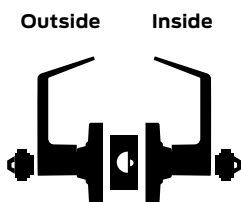

Schlage      ANSI  
**ND85PD**      -

#### Faculty restroom lock

- Outside lever is fixed.
- Entrance by key only.
- Push-button in inside lever activates visual occupancy indicator, allowing only emergency master key to operate.
- Turn inside lever or close door to release visual occupancy indicator.
- Rotation of inside spinner-button provides lock-out feature by keeping indicator thrown.

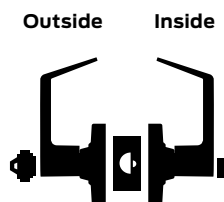

### Vandlgard functions

Schlage      ANSI  
**ND91PD**      **F82**

#### Entrance/office lock

- Push-button locking.
- Push-button disengages outside lever until locked with key or by turning inside lever.
- Vandlgard is designed to disengage outside spindle from latch when locked.

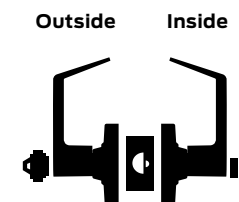



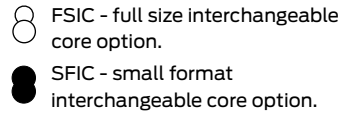
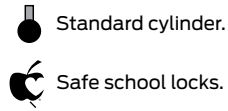

**†Caution:**  
Double cylinder locks are a life safety hazard in times of emergency and their use is not recommended. Installation should be in accordance with existing codes only.

Schlage ANSI  
**ND92PD F109**

**Entrance lock**

- Turn/push-button locking: Pushing and turning button disengages outside lever, requiring using of key until button is manually unlocked.
- Push-button locking: Pushing button disengages outside lever until unlocked by key or by turning inside lever.
- Vandlgard is designed to disengage outside spindle from latch when locked.

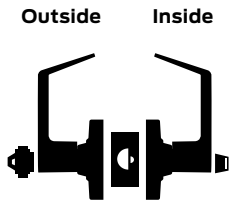

Schlage ANSI  
**ND93PD F88**

**Vestibule lock**

- Latch retracted by key from outside when outside lever is disengaged by key in inside lever.
- Inside lever is always unlocked.
- Vandlgard is designed to disengage outside spindle from latch when locked.

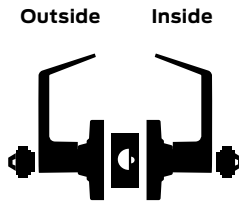

Schlage ANSI  
**ND94PD F84**

**Classroom lock**

- Outside lever disengaged and unlocked by key.
- Inside lever always unlocked.
- Vandlgard is designed to disengage outside spindle from latch when locked.

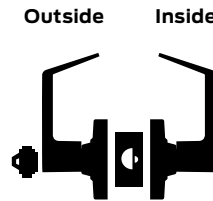

Schlage ANSI  
**ND95PD -**

**Classroom security lock**

- Key in either lever locks or unlocks outside lever.
- Inside lever is always unlocked.

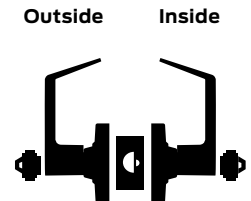

Schlage ANSI  
**ND96PD F86**

**Storeroom lock**

- Outside lever always disengaged.
- Entrance by key only.
- Inside lever is always unlocked.
- Vandlgard is designed to disengage outside spindle from latch when locked.

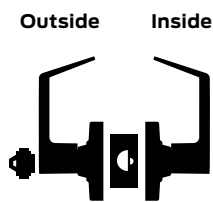

Available with RX feature



Schlage ANSI  
**ND96PDEL -**

**Electrically locked (fail safe)**

- Outside lever continuously disengaged electrically.
- Unlocked by key outside or by switch or power failure.
- Auxiliary latch deadlocks latchbolt when door is closed.
- Inside lever always free for immediate exit.
- Vandlgard is designed to disengage outside spindle from latch when locked.

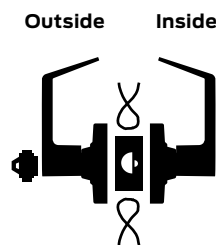

Schlage ANSI  
**ND96PDEU -**

**Electrically unlocked (fail secure)**

- Outside lever continuously disengaged until unlocked by key or electric current.
- Auxiliary latch deadlocks latchbolt when door is closed.
- Inside lever always free for immediate exit.
- Vandlgard is designed to disengage outside spindle from latch when locked.

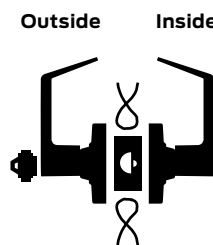

Schlage ANSI  
**ND97PD F90**

**Corridor lock**

- Locked or unlocked by key from outside.
- Push-button locking from inside.
- Turning inside lever or closing door releases button.
- When outside lever is locked by key it can only be unlocked by key.
- Inside lever is always unlocked.
- Vandlgard is designed to disengage outside spindle from latch when locked.

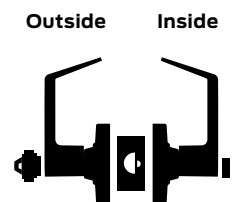

# ND Series electrified locks

ND Series locks are available for electrically locking and unlocking controls for high security and fire safety applications. They are UL Listed and rated for both fire and electrical single-point locking on labeled doors. RX feature is available on ND10, ND12, ND80 and ND96 families. Switch is ready to be used in a normally open or normally closed application.

Special prep required for RX feature. See service manual for details.

## Electrical requirements

**Voltage**  
24VAC or 24VDC

**Holding current**  
.15A or .35A

**Operating temperature**  
Maximum +151°F (+66°C)  
Minimum -31°F (-33°C)

Note: All installations should be in accordance with local electrical codes.



## Typical wiring diagram for electrified locks

### AC power source – EL or EU

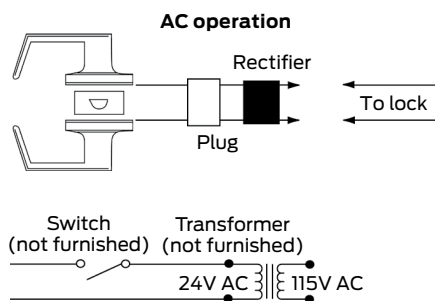

Rectifier used on AC operation unit only.  
.35A @ 24V (current requirements per lock)

### DC power source – EL or EU

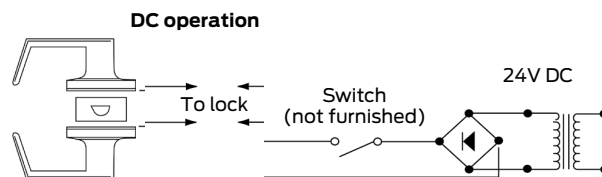

.15A @ 24V (current requirements per lock)

### AC and DC application

Cut as close to plug as possible for DC operation.

Plug into solenoid for AC operation. Discard for DC operation.

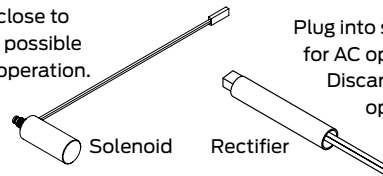

## ND Series other special functions

### ND30D

#### Patio lock

Push button locking. Turning inside lever or closing door releases button, preventing a lock-out. Inside lever always free for immediate egress. Specify per XN12-007.

### ND25 x 80PD

#### Storeroom exit lock

Blank plate outside. Key in fixed inside lever retracts latch. Specify per XN12-005.

### ND25 x 70PD

#### Classroom exit lock

Blank plate outside. Key locks or unlocks inside lever. Specify per XN12-004.

### ND60PD

#### Vestibule with closed outside lever

Same as ND60 except outside lever is closed. Inside lever always free for immediate egress. Specify per XN12-001.

### ND70 x 80PD

#### Classroom by storeroom lock

Key locks and unlocks outside lever. Key in fixed inside lever retracts latch. Specify per XN12-006.

### ND72PD

#### Communicating lock

Key in either lever locks and unlocks on lever. Specify per XN12-002.

### ND72PD



#### Vandlgard communicating lock

Communicating, ND72, lock with Vandlgard. Key in either lever locks and unlocks own lever. Both inside and outside levers are clutching. Specify per XN12-003.

# Cylinders and key systems



## Protect new key systems with Everest 29

Schlage can help you design a system that can grow and change along with your needs, allowing you the flexibility to upgrade your security without the need to replace all your cylinders.

What it operates	What it is
<ul style="list-style-type: none"> <li>Everest 29 Primus® XP cylinders</li> <li>Everest 29 restricted cylinders</li> <li>Everest 29 open cylinders</li> </ul>	<b>UL 437 version</b> <ul style="list-style-type: none"> <li>UL 437 versions provide drill and pick resistance and withstand physical attack</li> <li>High security cylinders have a second set of pins for added security</li> <li>Patented key control sold with various levels of geographic exclusivity</li> <li>Keys operate high security, as well as restricted security or standard security cylinders</li> <li>Available only in conventional</li> </ul>
<ul style="list-style-type: none"> <li>Everest 29 Primus XP cylinders</li> <li>Everest 29 restricted cylinders</li> <li>Everest 29 open cylinders</li> </ul>	<b>Controlled access</b> <ul style="list-style-type: none"> <li>Patented key control sold with various levels of geographic exclusivity</li> <li>High security cylinders have a second set of pins for added security and pick resistance</li> <li>Keys operate high security, as well as restricted security or standard security cylinders</li> <li>Available only in conventional and FSIC</li> </ul>  <p><b>EVEREST 29<sup>®</sup> PRIMUS XP</b> High security</p>
<ul style="list-style-type: none"> <li>Everest 29 restricted cylinders</li> </ul>	<ul style="list-style-type: none"> <li>Key distribution is restricted duplication must be authorized</li> <li>End user's ID numbers are stamped on all keys, enabling Schlage to identify the source of any unauthorized keys</li> <li>Patent-protected keys are drop-shipped from the factory directly to an end-user specified location to guarantee exclusivity</li> <li>Available in conventional, SFIC and FSIC</li> </ul>  <p><b>EVEREST 29<sup>®</sup></b> Restricted security</p>
<ul style="list-style-type: none"> <li>Everest 29 open cylinders</li> </ul>	<ul style="list-style-type: none"> <li>Patented key blanks can be stored by commercial locksmiths and security dealers</li> <li>Keys can be duplicated without any paperwork or signature verification</li> <li>Sold only through commercial outlets</li> <li>Available in conventional and FSIC</li> </ul>  <p><b>EVEREST 29<sup>®</sup></b> Standard security</p>

## Upgrade existing classic key systems with Primus XP

Schlage offers key system solutions that are ideal for upgrading an existing key system to control key management. Our patent-protected cylinders help prevent unauthorized duplication and can be integrated into virtually any existing system.



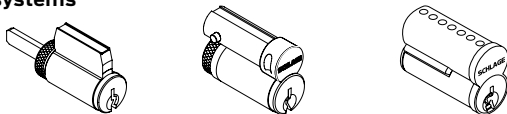

What it is	What it operates
<b>UL 437 version</b> <ul style="list-style-type: none"> <li>UL 437 versions provide drill and pick resistance and withstand physical attack</li> <li>High security cylinders have a second set of pins for added security</li> <li>Patented key control sold with various levels of geographic exclusivity</li> <li>Keys operate high security, as well as restricted security or standard security cylinders</li> <li>Available only in conventional</li> </ul>	<ul style="list-style-type: none"> <li>Primus XP cylinders</li> <li>Classic cylinders</li> </ul>
 <p><b>PRIMUS XP</b> High security</p>	<b>Controlled access</b> <ul style="list-style-type: none"> <li>Patented key control sold with various levels of geographic exclusivity</li> <li>High security cylinders have a second set of pins for added security and pick resistance</li> <li>Keys operate high security, as well as restricted security or standard security cylinders</li> <li>Available only in conventional</li> </ul> <ul style="list-style-type: none"> <li>Primus XP cylinders</li> <li>Classic cylinders</li> </ul>
 <p><b>CLASSIC</b> Basic security</p>	<ul style="list-style-type: none"> <li>Keys can be duplicated at most retail and commercial points of sale with no restrictions</li> <li>Recommended only for residential applications or existing commercial systems that cannot rekey</li> <li>Can be upgraded to Primus XP without rekeying the entire facility</li> <li>Available in conventional and FSIC</li> </ul> <ul style="list-style-type: none"> <li>Classic cylinders</li> </ul>

### Compatible key systems



Schlage key systems	Key-in-lever cylinder	Full size interchangeable core	Small format interchangeable core
Primus XP	X	X	
Everest 29	X	X	X
Classic	X	X	
Other key systems	(6 Pin FSIC)		
Sargent	X	X	X
Corbin Russwin		X	X
Yale		X	X

### Cylinder options (how to order)

Cylinder	Order suffix	Description
	LD SAR	Sargent Key-in-lever
	JD SAR	Sargent Full size interchangeable core 6-pin cylinder
	JD C06	Corbin Ruswin Full size interchangeable core 6-pin cylinder
	JD YA6	Yale Full size interchangeable core 6-pin cylinder



## Standard cylinders

Standard cylinders are available in Classic keyways or in patented Everest 29 keyways. Specify keyway to differentiate between Everest 29 and Classic.

Example: C or CP (Classic) vs. S123 (Everest 29).

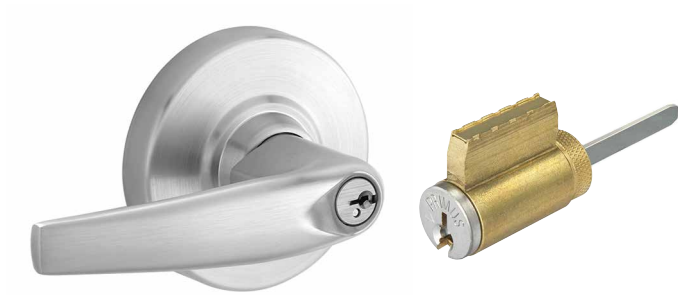

## Full size interchangeable core 8

Schlage FSIC full size interchangeable core (IC) locksets allow immediate rekeying at the door simply by using a special control key to replace the core.



Available in all lever designs, full size interchangeable cores can be integrated into any 5 or 6-pin Schlage key.

### Standard cylinders - options

- 6-pin conventional (standard)
- Primus XP high security
- Primus XP UL437 Listed high security
- Hotel cylinder
- Temporary construction plug, plastic for functions

Available in 606 and 626 finish only.  
Everest 29 S123 keyway standard.

### Full size interchangeable cores - options

- Conventional core
- Primus XP high security core
- FSIC driver

Available in 606 and 626 finish only.  
Everest 29 S123 keyway standard.

## Primus XP access control and high security cylinders

Classic Primus XP cylinders are recommended for upgrading existing Classic key systems. Due to its extended patent life, the newly designed Everest 29 Primus XP is recommended for new key systems and for upgrading existing Everest 29 key systems. Specify keyway to differentiate between Everest 29 and Classic.

Example: C or CP (Classic) vs. S123 (Everest 29).

## Small format interchangeable core

Available in all lever designs, the SFIC (small format IC) option is designed for Schlage Everest 29 R family restricted keyway cores and is also compatible with other small format interchangeable cores.

### Disposable construction core

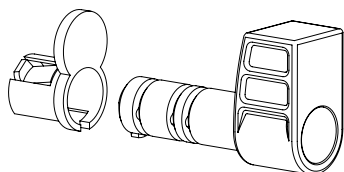

### Small format interchangeable cores - options

- 7-pin uncombined Everest 29 R family restricted keyways ●
- 7-pin combined Everest 29 R family restricted keyways ●
- 6-pin uncombined Falcon / Best keyways - all keyways ▲
- 7-pin uncombined Falcon / Best keyways - all keyways ▲
- Disposable plastic construction core
- SFIC driver
- Spacer for 6-pin cores

Available 606 and 626 , 613 (simulated) finish only. Specify keyway for existing systems.

- Cores are available in Best A, D, E, F, G, H, J, K, L, and M keyways. Specify keyway by suffixing "B" to keyway letter, e.g. "AB".
- ▲ Restricted keyway cores require a letter of authorization from the end user. Schlage assigns the keyway when establishing new Everest 29 restricted key systems.

\*M204-152 does not have a finish option.

# Latches

ND Series latches are adjustable for flat or beveled edge doors. Latches and strikes are furnished in brass, bronze, or chrome finishes to be compatible with lock trim. When ordering, specify quantity, part number, and finish. All ND Series latches have 1/2" throw and 1" housings except 2 3/8" backset latches, which includes sleeve G506-815 to fill a 1" edge bore. Standard latches are shown in bold type.

## Latches - options

Backset	Description	Deadlatch 1/2" (13 mm) throw	Springlatch 1/2" (13 mm) throw
<b>2 3/8"</b> (60 mm)	<b>1 1/8" (29 mm) x 2 1/4" (57 mm) square corner</b>	3	—
	<b>1 1/8" (29 mm) x 2 1/4" (57 mm) square corner</b>	3	—
<b>2 3/4"</b> (70 mm)	<b>1 1/8" (29 mm) x 2 1/4" (57 mm), standard square corner</b>	3	3
	<b>1 1/8" (29 mm) x 2 1/4" (57 mm) throw, anti-friction door latch, square corner</b>	3	—
<b>3 3/4"</b> (95 mm)	<b>1 1/8" (29 mm) x 2 1/4" (57 mm), square corner</b>	3	3
<b>5"</b>	<b>Backset extension link</b>	3	—

### Deadlatch

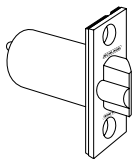

### Springlatch

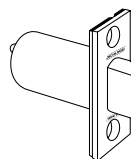

3/4" Throw anti-friction deadlatch for pairs of fire doors

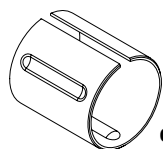
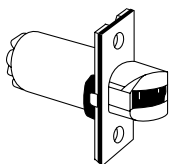

**G506-815**

## Long backsets

ND Series locks with 5" backsets are normally furnished with 1 1/8" faceplates and 1" housings. Links installed in metal doors require one A501-567 sleeve and 43-005 (order separately) to join latch and link.

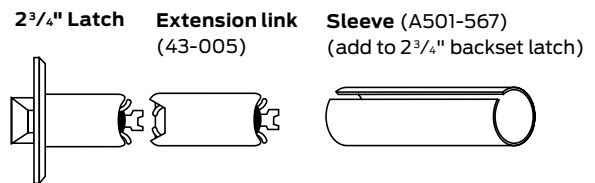

## Door reinforcement

Reinforcing unit is required to reinforce and help prevent the collapse of hollow metal doors when locksets are tightly mounted. This kit should be used with long backsets for ND Series lock installations in hollow metal doors to prevent lateral movement of the latchbolt. Specify door thickness, 1 3/8" (35 mm) or 1 3/4" (44 mm), when ordering reinforcement kits.

**Reinforcement kit**  
37-001

Kit includes:  
**Reinforcement**  
A501-566 for 1 3/8" doors or  
A501-565 for 1 3/4" doors

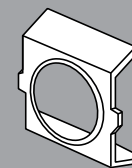

# Strikes

All Schlage strikes are furnished complete with screws.

The standard ND Series strike has a  $1\frac{3}{16}$ " lip.

When ordering separately specify quantity, product number, finish, and lip length. Standard strikes are shown in bold type.

## Strikes - options

- $1\frac{1}{8}$ " x  $2\frac{3}{4}$ " (28 mm x 70 mm) square corner, T-strike, box -  $1\frac{1}{8}$ " (28 mm) lip length
- $1\frac{1}{8}$ " x  $2\frac{3}{4}$ " (28 mm x 70 mm) square corner, T-strike, box -  $1\frac{1}{2}$ " (38 mm) lip length
- $1\frac{1}{4}$ " x  $4\frac{7}{8}$ " (32 mm x 124 mm) standard, no box, ANSI -  $1\frac{3}{16}$ " (30 mm) lip length
- $1\frac{1}{4}$ " x  $4\frac{7}{8}$ " (32 mm x 124 mm) ANSI, no box -  $1\frac{3}{8}$ " (35 mm) lip length
- Box for 10-025 ANSI strike

**ANSI strike—standard**  
(10-025)  
 $1\frac{1}{4}$ " x  $4\frac{7}{8}$ " x  $\frac{3}{32}$ "



**Square corner box strike**  
(10-013)  
 $1\frac{1}{8}$ " x  $2\frac{3}{4}$ " x  $\frac{3}{32}$ "



# Rabbeted latch and strike kit

Rabbeted latch and strike kit finishes: 605, 626.

This kit adapts square corner latches and  $2\frac{3}{4}$ " (28 mm) high strikes for  $\frac{1}{2}$ " (13 mm) rabbeted door and frame preparations.

**Rabbeted latch and strike kit**  
(39-030)

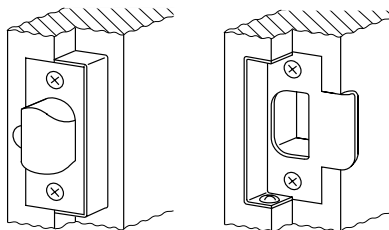

# Accessories

**$1\frac{3}{8}$ " D Series lever door spacer\***



XN12-012

\*For installation on  $1\frac{3}{8}$ ", doors, two (2) spacers are required. Specify finish.

# Specifications

**Handing:**

All ND Series lever locksets are non-handed.

**Door thickness:**

1<sup>5</sup>/<sub>8</sub>" to 2<sup>1</sup>/<sub>8</sub>" (41 mm–54 mm) standard including Vandlgard® functions. 1<sup>3</sup>/<sub>4</sub>" - 2" for function D85. See accessories (Page 21) for spacers required for 1<sup>3</sup>/<sub>8</sub>" doors.

**Backset:**

2<sup>3</sup>/<sub>4</sub>" (70 mm) standard. 2<sup>3</sup>/<sub>8</sub>", 3<sup>3</sup>/<sub>4</sub>" and 5" (60 mm, 95 mm, 127 mm) optional.

**Faceplate:**

Brass, bronze or stainless steel. 1<sup>1</sup>/<sub>8</sub>" x 2<sup>1</sup>/<sub>4</sub>" (29 mm x 57 mm) square corner, beveled.

**Lock chassis:**

Zinc plated for corrosion resistance.

**Latch bolt:**

Steel, 1/2" (12 mm) throw, deadlocking on keyed and exterior functions. 3/4" (19 mm) throw anti-friction latch available for pairs of fire doors.

**Exposed trim:**

Levers: Pressure cast zinc, plated to match finish symbols.  
Roses: Brass, bronze or zinc.

**Strike:**

ANSI curved lip strike 1<sup>1</sup>/<sub>4</sub>" x 4<sup>7</sup>/<sub>8</sub>" x 1<sup>3</sup>/<sub>16</sub>" lip to center standard. Optional strikes, lip lengths and ANSI strike box available. See page 21.

**Cylinder and keys:**

6-pin Everest 29 S123 keyway standard with two patented nickel silver keys per lock.

**Keying options:**

Interchangeable core and Primus high security cylinders.  
Master keying, grand master keying and construction keying.

**Warranty:**

Ten-year limited for all mechanical functions including Vandlgard; 1 year limited for electrified functions.

# Certifications

**ANSI:**

Meets the requirements of ICC A117.1 Accessible and Usable Buildings and Facilities.

**Federal:**

Meets FF-H-106C Series 161.

**California Referenced Standards Code:**

(Formerly Title 19, California State Fire Marshal Standard)  
All levers with a return to door of 1/2" (64 mm) or less comply. Most Schlage levers comply (see lever designs section for compliance).

**MEA certification:**

All electrified locking (fail-safe, unlocked by switch or power failures) functions accepted for use in New York City by the City of New York, Department of Buildings (MEA 24-04-E).

All levers with less than 1/2" (64 mm) returns comply with California Fire Safety Codes.

**Florida Building Commission:**

3/4" and 1/2" throw latch approved for Hurricane Resistance with Miami-Dade County, Florida.

**UL / cUL:**

All locks listed for A label single doors, 4' x 8'.  
Letter F and UL symbol.

**ADA compliant:**

Schlage Lock Company offers a wide selection of locks designed to meet the Americans with Disabilities Act.





## About Allegion

Allegion (NYSE: ALLE) creates peace of mind by pioneering safety and security. As a \$2 billion provider of security solutions for homes and businesses, Allegion employs more than 8,000 people and sells products in more than 120 countries across the world. Allegion comprises 27 global brands, including strategic brands CISA®, Interflex®, LCN®, Schlage® and Von Duprin®.

For more, visit [www.allegion.com](http://www.allegion.com)

*aptiQ* ■ LCN ■ **SCHLAGE** ■ STEELCRAFT ■ VON DUPRIN