



# ND Series

Locks & latches



Fire Rated: Tested on fire door assemblies in accordance with Australian Standards, refer fire door manufacturer for specific approval details

ND Series locks are recommended when the highest standards of quality and performance are required. Designed for durability and function, precision manufactured to exact tolerances, the ND Series is best suited for commercial, institutional and industrial use. The specialised functions satisfy virtually any cylindrical lock application. The ND lever styles are designed for maximum accessibility and security.

## Features

- Cylindrical housing: heavy gauge cold rolled steel mechanisms are corrosion treated for normal atmosphere conditions
- Independent heavy duty spring cages for effective lever support
- Levers have thru-bolted mechanism for positive fixing to door
- ND Vandlgard series locks offer a high degree of resistance to physical abuse
- Concealed mounting screws
- Lever design non-handed
- Tested to exceed 3,000,000 cycles, greatly exceeding the 800,000 cycle ANSI/BHMA Grade 1 requirement
- Exceeds ANSI/BHMA A156.2 Series 4000 Grade 1 lock lever torque requirements
- The 10 year warranty provides specifiers and users with assured quality and performance

# Specification guide

Function	Lever	Finish
Passage latch .....ND10S	Rhodes ..... RH	Satin chrome plate.....SCP
Privacy latch ..... ND40S		
Entrance lock .....ND53PD		
Store lock ..... ND66PD		
Classroom lock .....ND70PD		
Storeroom lock ..... ND80PD		
Single dummy trim ..... ND170		
Vandlgard entrance/office lock ..... ND91PD		
Vandlgard entrance lock .....ND92PD		
Vandlgard classroom lock .....ND94		
Vandlgard storeroom lock .....ND96		

- Function  
Select the desired function e.g. Entrance lock ..... ND53PD
- Lever  
Select the lever e.g. Rhodes ..... ND53PDRH
- Finish  
Select the desired finish e.g. Satin chrome plate ..... ND53PDRHSCP

## Rhodes

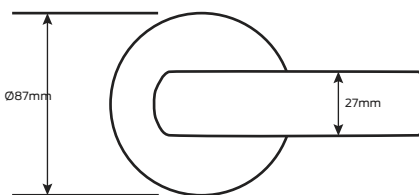
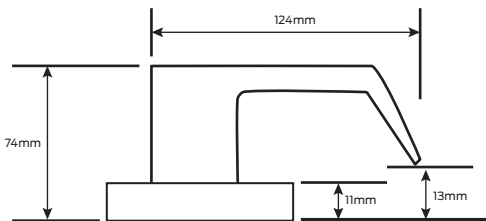



### Specifications

<b>Door type</b>	Timber or metal
<b>Door thickness</b>	41mm to 54mm
<b>Chassis</b>	Cold rolled steel, corrosion treated
<b>Lever</b>	Pressure cast zinc, plated
<b>Forend</b>	Stainless steel
<b>Bolt</b>	Steel
<b>Strike plate</b>	Steel
<b>Backsets</b>	70mm standard, 60mm, 95mm and 127mm backset latches available
<b>Key cylinder</b>	Brass plug and cylinder housing, Schlage C6 pin keyway standard, Schlage E6 pin keyway optional, Schlage Everest D keyway optional
<b>Finish</b>	Satin chrome plate
<b>Warranty</b>	10 year mechanical

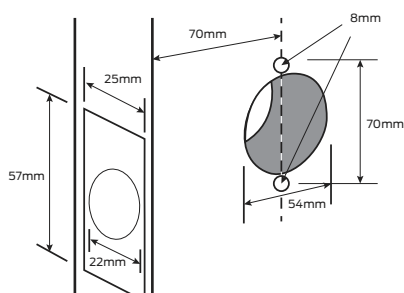



## Door preparation



## Schlage ND Series non-keyed

Function	Outside	Inside
<b>ND10S - Passage latch</b> Both levers always unlocked		
<b>ND40S - Bath/bedroom privacy lock</b> Push-button locking locks outside levers. Turning inside lever or closing door releases button. Outside lever has emergency release		
<b>ND170 - Single dummy trim</b> Dummy trim for one side of door. Used for door pull or as matching inactive trim		

## Schlage ND Series keyed

Function	Outside	Inside
<b>ND53PD- Entrance/office lock</b> Turn/push-button locking: pushing and turning button locks outside lever requiring use of key until button is manually unlocked. Push-button locking: pushing button locks outside lever until unlocked by key or by turning inside lever		
<b>ND66PD - Communicating door lock</b> Key in either lever locks or unlocks both levers		
<b>ND70PD - Classroom lock</b> Outside lever locked and unlocked by key. Inside lever always unlocked		
<b>ND80PD - Storeroom lock</b> Outside lever fixed. Entrance by key only. Inside lever always unlocked		

## ND Series Vandlgard option

ND Series keyed lever locks with Vandlgard provide vandal resistant technology. Designed for maximum accessibility, security, durability and function, Vandlgard sets the standard for door hardware in educational facilities and other applications subject to heavy traffic or abuse. The unique features of Vandlgard prevent damage to internal lock components caused by excessive force from individuals kicking, hitting or standing on the lever to gain access. In addition, total facility integration is available with the design and keying compatibility of heavy duty ND Series lever furniture with Vandlgard and standard ND Series lever functions.

Levers are replacing knobs in the marketplace. The benefit of added grip and leverage that levers provide to those with limited mobility has, however created the opportunity for increased abuse or vandalism. This abuse often renders the lock in operable, and in some cases, violates the security of the door. While this abuse is commonly associated with schools, it can and does occur in universities, office buildings, commercial and public buildings.

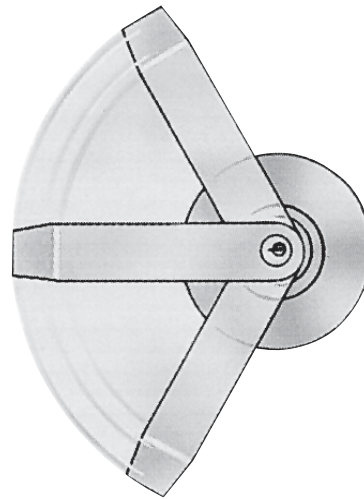

**Locked lever freely rotates up and down while remaining securely locked. The Vandlgard function also increases resistance to over-rotation of the lever.**

## Features

- Prevents through bolt loosening – special tapped holes in outside mounting plate resist loosening of through bolt
- Reduces lever wobble and play – a bushing support area is built into the cast mounting plate, eliminating excessive lever movement
- Resists vandalism – free wheeling lever eliminates the ability to stand or exert excessive force on the end of the lever
- Resists over-rotation of the lever – heavy steel lugs on lever hub and stainless steel lever are more than 55% stronger than industry standards

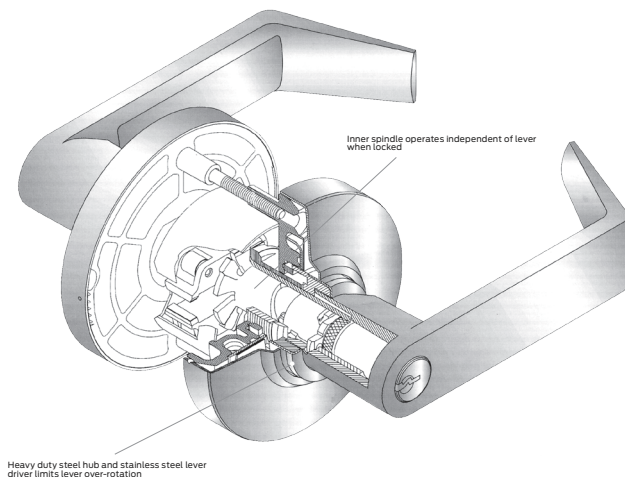

## Schlage ND Series Vandlgard

Function	Outside	Inside
<p><b>ND91PD - Entrance/office lock</b>            Pushing button locks (disengages) outside lever until unlocked with key or by turning inside lever. Inside lever always unlocked. Vandlgard is designed to disengage outside spindle from latch with in locked condition</p>		
<p><b>ND92PD - Entrance lock</b>            Turn/push-button locking pushing or pushing and turning button locks (disengages) outside lever requiring the use of a key. Inside lever always unlocked. Vandlgard is designed to disengage outside spindle from latch with in locked condition</p>		
<p><b>ND94 - Classroom lock</b>            Outside lever disengaged and unlocked by key. Inside lever always unlocked. Vandlgard is designed to disengage outside spindle from latch with in locked condition</p>		
<p><b>ND96 - Storeroom lock</b>            Outside lever always disengaged. Entrance by key only            Inside lever always unlocked. Vandlgard is designed to disengage outside spindle from latch when in locked condition</p>		

# Schlage ND Series accessories

## Springlatch

**Backset:** 60mm, 70mm, 95mm and 127mm  
**Finish:** Satin chrome plate

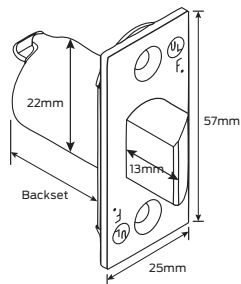

## Deadlatch

**Backset:** 60mm, 70mm, 95mm and 127mm  
**Finish:** Satin chrome plate

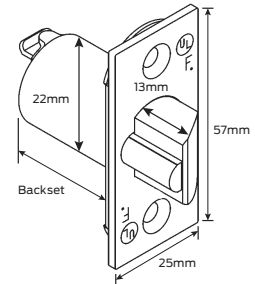

## Strikes

Optional lip lengths available  
**Finish:** Satin chrome plate

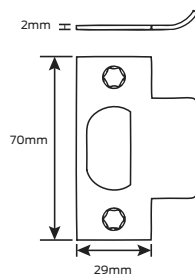

## Rebate kit

This kit adapts latches and strikes for 13mm rebated door and frame preparations

