



# Instruction Manual

High Traffic Swing Gate Operator

## RAM 300

Opening the way...



FOR CLASS I, II, III, IV VEHICULAR GATE OPERATORS

# TABLE OF CONTENTS

- Important Safety Requirements & Instructions ..... 1
- Responsibilities of Installers and Technicians ..... 2
- Important Safety Requirements by UL Standards..... 3
- Classes of Vehicular Gate Operators ..... 4
- General Specifications ..... 5
- Installation Specifications ..... 6
- Hookup Electrical Power - Gate Travel Adjustment ..... 7
- Standard Installation for Gates from 8' to 14' in Length ..... 7
- Standard Installation for Gates from 14' to 18' in Length ..... 8
- Space Required for Standard Gate in the Open Position ..... 8
- Compact Installation and Minimum Space Required ..... 9
- Sensor Installation ..... 10
- Pushbutton Controls & Master/Slave Installation ..... 11
- Dip Switch Configuration ..... 12-13
- Terminal Strip Connections ..... 14-15
- Ramset "Intelligate" Control Board ..... 16
- Wire Board Connections ..... 17
- Exploded View Parts Diagram ..... 18
- Bill of Materials ..... 19-20
- Troubleshooting Table ..... 21
- Gate Entrance Safety Precautions ..... 22
- Important Information for The Homeowner..... 23
- Optional Ramset Accessories ..... 24

 **Do not install this gate operator if you do not have experience or appropriate training with gate operators.**

 **IMPORTANT SAFETY REQUIREMENTS & INSTRUCTIONS**

**WARNING To reduce the risk of injury or death:**

<ol style="list-style-type: none"> <li>1. READ &amp; FOLLOW ALL INSTRUCTIONS.</li> <li>2. Never let children operate or play with gate controls. Keep the remote control away from children.</li> <li>3. Always keep people and objects away from the gate. NO ONE SHOULD CROSS THE PATH OF THE MOVING GATE.</li> <li>4. Test the vehicular gate operator monthly. The gate MUST reverse on contact with a rigid object or stop when an object activates the non-contact sensors. After adjusting the limit of travel, retest the vehicular gate operator. Failure to adjust and retest the vehicular gate operator properly can increase the</li> </ol>	<p>risk of injury or death.</p> <ol style="list-style-type: none"> <li>5. Use the emergency release <u>only when power switch or circuit breaker has been turned off</u>. Using the emergency release during a power failure can be a hazard if power is abruptly restored.</li> <li>6. KEEP GATES PROPERLY MAINTAINED. Read the owner's manual. Have a qualified service person make repairs to gate hardware.</li> <li>7. The entrance is for vehicles only. Pedestrians must use separate entrance.</li> <li>8. SAVE THESE INSTRUCITONS.</li> </ol>
--	--



## RESPONSIBILITIES OF INSTALLERS AND TECHNICIANS

### INSTALLATION:

- READ AND UNDERSTAND THE INSTRUCTION MANUAL BEFORE ATTEMPTING ANY INSTALLATION.
- DO NOT EXCEED THE EQUIPMENT SPECIFICATIONS.
- INSURE A SAFE AND PROPER INSTALLATION.
- INSTALL THIS EQUIPMENT IN ACCORDANCE WITH THE UL 325 SPECIFICATIONS.
- MAKE SURE TO ELIMINATE ANY PINCH POINTS EXISTING ON THE INSTALLATION. (ie. ROLLERS, ARMS...etc.)

### SAFETY DEVICES:

- REMOVE OR PROTECT ALL PINCH POINTS FROM GATE OPERATORS ARMS.
- MAKE SURE EVERY INSTALLATION HAS A MINIMUM OF ONE SAFETY DEVICE (SUCH AS A PHOTOELECTRIC EYE OR LOOP DETECTOR).
- CHECK THE E.R.D. SENSITIVITY.
- MAKE SURE THAT ALL AREAS AROUND THE GATE ARE SAFE AND SECURE. (SUCH AS THE FRONT, REAR, AND TRAVEL AREA).

### COMMUNICATE WITH THE END-USER

- INSTRUCT THE END USER ON HOW TO SAFELY OPERATE ALL FUNCTIONS OF THE OPERATOR.
- INSTRUCT THE END-USER ON HOW TO SAFELY USE THE EMERGENCY RELEASE.
- CLEARLY LABEL AND IDENTIFY THE CIRCUIT BREAKER FOR THE OPERATOR.
- SHOW THE END-USER THE LOCATION OF THE CIRCUIT BREAKER FOR THE OPERATOR.
- THOROUGHLY EXPLAIN ANY AND ALL WARRANTIES ASSOCIATED WITH THE OPERATOR AND INSTALLATION.
- KEEP A COPY OF EACH MANUAL HANDY FOR FUTURE REFERENCES.
- PROVIDE THE END-USER WITH THE "HOME OWNERS MANUAL PACKET" (INCLUDED WITH EVERY OPERATOR).

## IMPORTANT SAFETY REQUIREMENTS BY UL STANDARDS

**Prior to installation, the following must be observed: (per UL 325.56.8.4)**

- a) Install the gate operator only when:
  - 1) The operator is appropriate for the construction of the gate and the usage Class of the gate,
  - 2) All openings of a horizontal slide gate are guarded or screened from the bottom of the gate to a minimum of 4 feet (1.22 m) above the ground to prevent a 2 1/4 inch (57.2 mm) diameter sphere from passing through the openings anywhere in the gate, and in that portion of the adjacent fence that the gate covers in the open position,
  - 3) All exposed pinch points are eliminated or guarded, and
  - 4) Guarding is supplied for exposed rollers.
- b) The operator is intended for installation only on gates used for vehicles. Pedestrians must be supplied with a separate access opening. The pedestrian access opening shall be designed to promote pedestrian usage. Locate the gate such that persons will not come in contact with the vehicular gate during the entire path of travel of the vehicular gate.
- c) The gate must be installed in a location so that enough clearance is supplied between the gate and adjacent structures when opening and closing to reduce the risk of entrapment. Swinging gates shall not open into public access areas.
- d) The gate must be properly installed and work freely in both directions prior to the installation of the gate operator. Do not over-tighten the operator clutch or pressure relief valve to compensate for a damaged gate.
- e) For gate operators utilizing Type D protection:
  - 1) The gate operator controls must be placed so that the user has full view of the gate area when the gate is moving.
  - 2) The placard as required by 58.1.6 shall be placed adjacent to the controls,
  - 3) An automatic closing device (such as a timer, loop sensor, or similar device) shall not be employed, and
  - 4) No other activation device shall be connected.
- f) Controls intended for user activation must be located at least six feet (6') away from any moving part of the gate and where the user is prevented from reaching over, under, around or through the gate to operate the controls. Outdoor or easily accessible controls shall have a security feature to prevent unauthorized use.
- g) The stop and/or reset button must be located in the line-of-sight of the gate. Activation of the reset control shall not cause the operator to start.
- h) A minimum of two (2) WARNING SIGNS shall be installed, one on each side of the gate where easily visible.
- i) For gate operators utilizing a non-contact sensor in accordance with UL 31.1.1:
  - 1) See instructions on the placement of non-contact sensors for each Type of application.
  - 2) Care shall be exercised to reduce the risk of nuisance tripping, such as when a vehicle, trips the sensor while the gate is still moving, and
  - 3) One or more non-contact sensors shall be located where the risk of entrapment or obstruction exists, such as the perimeter reachable by a moving gate or barrier.
- j) For a gate operator utilizing a contact sensor in accordance with 31.1.1:
  - 1) One or more contact sensors shall be located where the risk of entrapment or obstruction exists, such as at the leading edge, trailing edge, and postmounted both inside and outside of a vehicular horizontal slide gate.
  - 2) One or more contact sensors shall be located at the bottom edge of a vehicular vertical lift gate.
  - 3) One or more contact sensors shall be located at the pinch point of a vehicular vertical pivot gate.
  - 4) A hardwired contact sensor shall be located and its wiring arranged so that the communication between the sensor and the gate operator is not subjected to mechanical damage.
  - 5) A wireless contact sensor such as one that transmits radio frequency (RF) signals to the gate operator for entrapment protection functions shall be located where the transmission of the signals are not obstructed or impeded by building structures, natural landscaping or similar obstruction. A wireless contact sensor shall function under the intended end-use conditions.
  - 6) One or more contact sensors shall be located on the inside and outside leading edge of a swing gate. Additionally, if the bottom edge of a swing gate is greater than 6 inches (152 mm) above the ground at any point in its arc of travel, one or more contact sensors shall be located on the bottom edge.
  - 7) One or more contact sensors shall be located at the bottom edge of a vertical barrier (arm).



## CLASSES OF VEHICULAR GATE OPERATORS

**Vehicular horizontal slide-gate operator (or system)** - A vehicular gate operator (or system) that controls a gate which slides in a horizontal direction that is intended for use for vehicular entrance or exit to a drive, parking lot, or the like.

**Vehicular swing-gate operator (or system)** - A vehicular gate operator (or system) that controls a gate which swings in an arc in a horizontal plane that is intended for use for vehicular entrance or exit to a drive, parking lot or the like.

**Residential vehicular gate operator-Class I** - A vehicular gate operator (or system) intended for use at a home of one-to four single family dwellings, or a garage or parking area associated there with.

**Commercial/general access vehicular gate operator-Class II** - A vehicular gate operator (or system) intended for use in a commercial location or building such as a multi-family housing unit (five or more single family units), hotels, garages, retail stores, or other buildings serving the general public.

**Industrial/limited access vehicular gate operator-Class III** - A vehicular gate operator (or system) intended for use in an industrial location or building such as a factory or loading dock area or other locations not intended to service the general public.

**Restricted access vehicular gate operator-Class IV** - A vehicular gate operator (or system) intended for use in a guarded industrial location or building such as an airport security area or other restricted access locations not servicing the general public, in which unauthorized access is prevented via supervision by security personnel.

## RECOMMENDED ELECTRICAL CONNECTION

A 3 wire, 120 VAC electrical circuit with a 15 amps independent circuit breaker for single operator and a 20 amps for Master/Slave. Ideally, the electrical conduits should exit the concrete under the operator. Low voltage control wires must be run in a separate conduit to the operator.

**NOTE:** Always consult and follow all local building and electrical codes prior to installation.

## RECOMMENDED WIRE GAUGE

INPUT POWER	MOTOR HP	AMPERES	
		RUN	START
120V Single Phase	1/2	4.7	5.0

MAXIMUM CONDUIT DISTANCE IN FEET USING COPPER WIRE BY WIRE SIZE			
14ga.	12ga.	10ga.	8ga.
up to 100'	100-350'	350-650'	800'

# RAM 300

## GENERAL SPECIFICATIONS:

**MAXIMUM GATE SIZE & WEIGHT:** 18' @ 1000 lbs.

**GATE TRAVELING SPEED:** Approx. 90° opening in 14 sec.

**MOTOR:** 1/2 hp, 120 VAC, 4.7 amp, 1625 rpm.

**CYCLES:** Continuous.

**OPERATING TEMPERATURE:** -10° F to 160° F.

**HEAVY DUTY WORM GEAR:** Lubricated by oil bath gives smooth and quiet operation.

**CHASSIS:** 3/16" hot rolled steel.

**FINISH:** Gold/zinc plated to inhibit corrosion.

**POWER FAILURE RELEASE:** \*Exclusive foot pedal release.

**OVERALL DIMENSIONS:** H 27" - L 16 1/2" - W 20".

**SHIPPING WEIGHT:** 110 lbs.

\*Exclusive foot pedal release disengages gate from motor so it can be opened manually.



**WARNING:** Do not exceed the specifications.







### HOOKUP ELECTRICAL POWER



Figure 3

Outlet Leads

Note: Eliminate outlet leads. Hookup your electrical 15 amp wires direct to outlet.

### GATE TRAVEL ADJUSTMENT



**CAUTION:**  
Clutch tension bolts need to be tightened to a minimum of 40 lbs. above weight of gate in order to avoid slipping.

Figure 4

Gate travel is adjusted by loosening the limit Cams and positioning them until proper gate travel has been achieved.

### STANDARD INSTALLATION FOR GATES FROM 8' TO 14' IN LENGTH

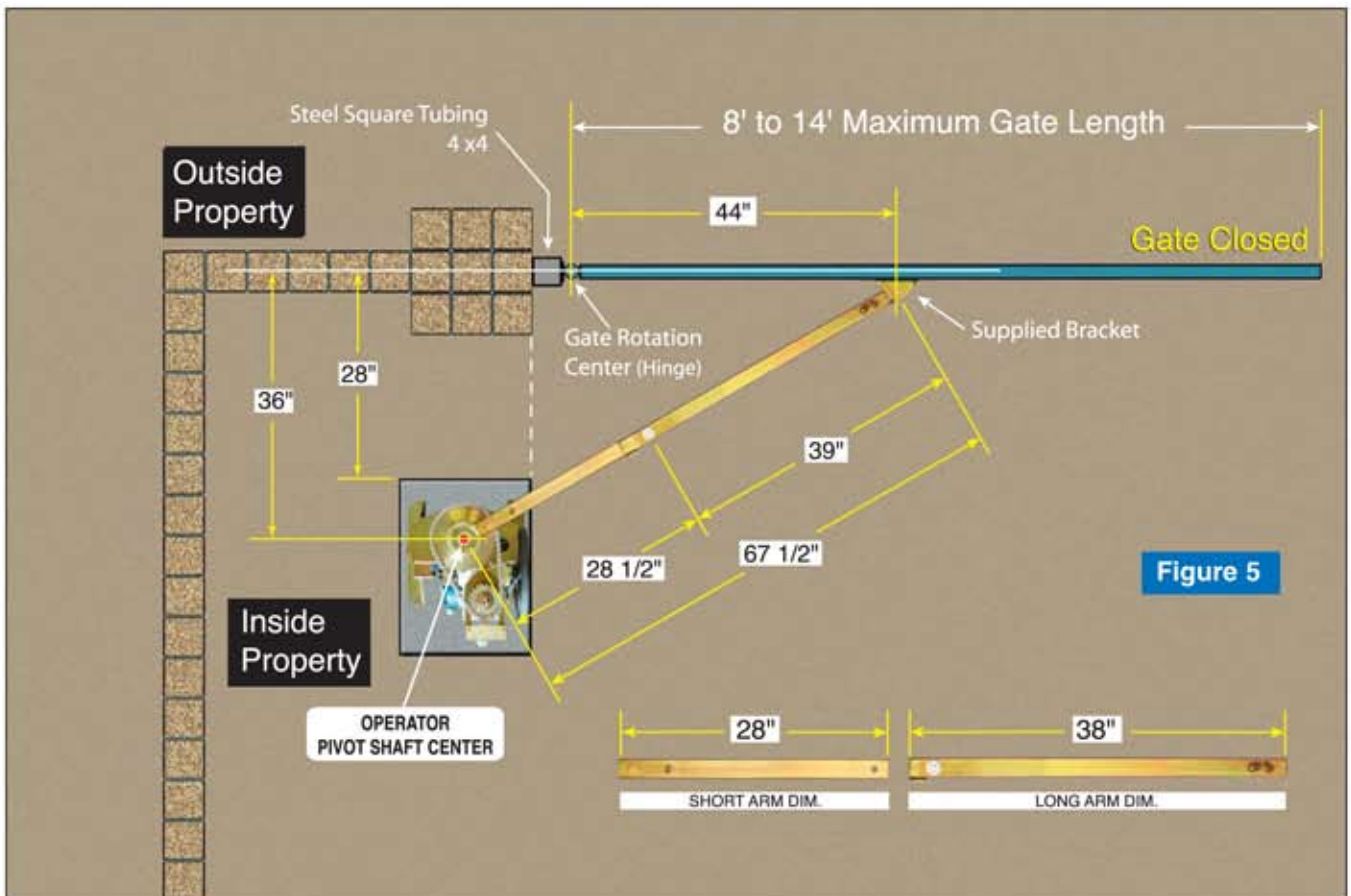
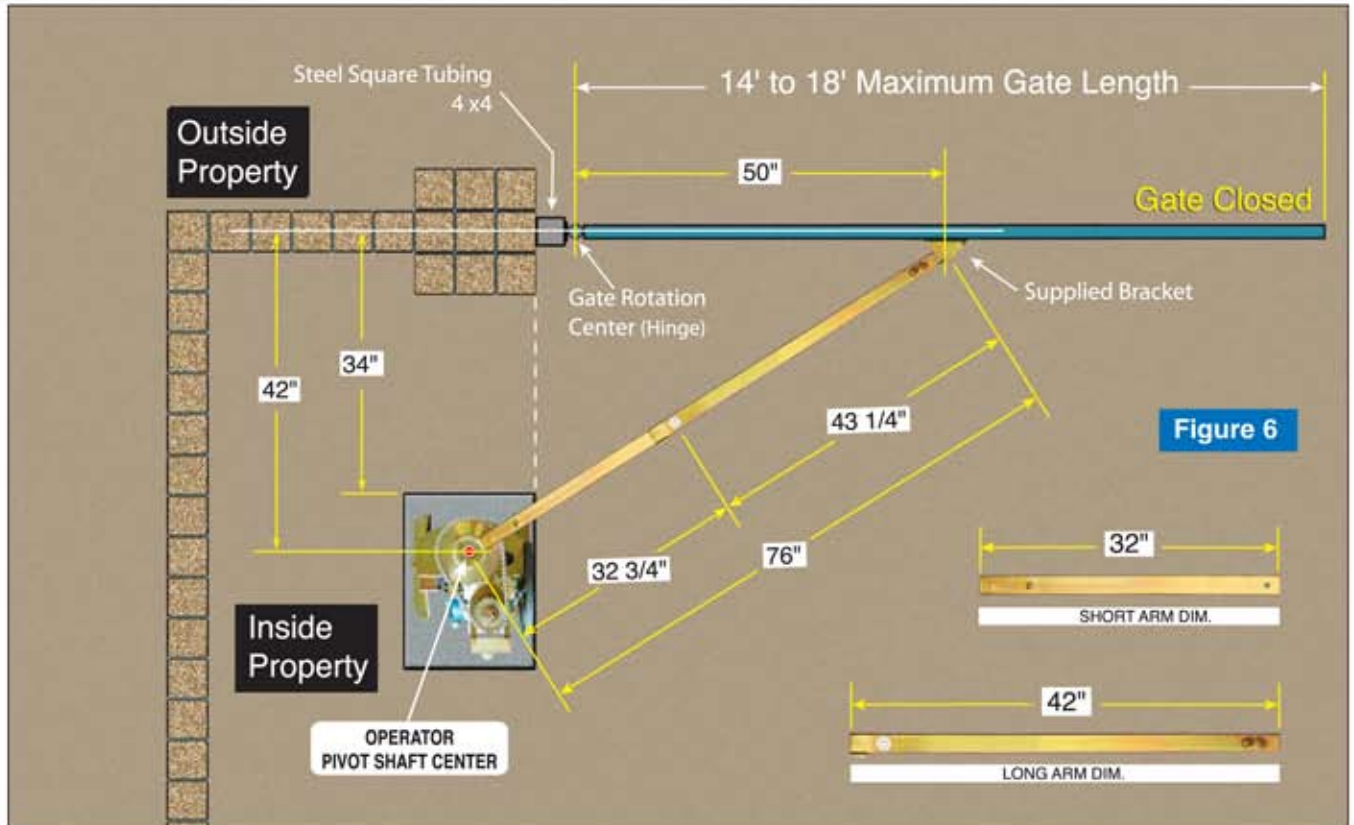

Figure 5



# STANDARD INSTALLATION FOR GATES FROM 14' TO 18' IN LENGTH

RAM 300



# SPACE REQUIRED FOR A STANDARD GATE IN THE OPEN POSITION

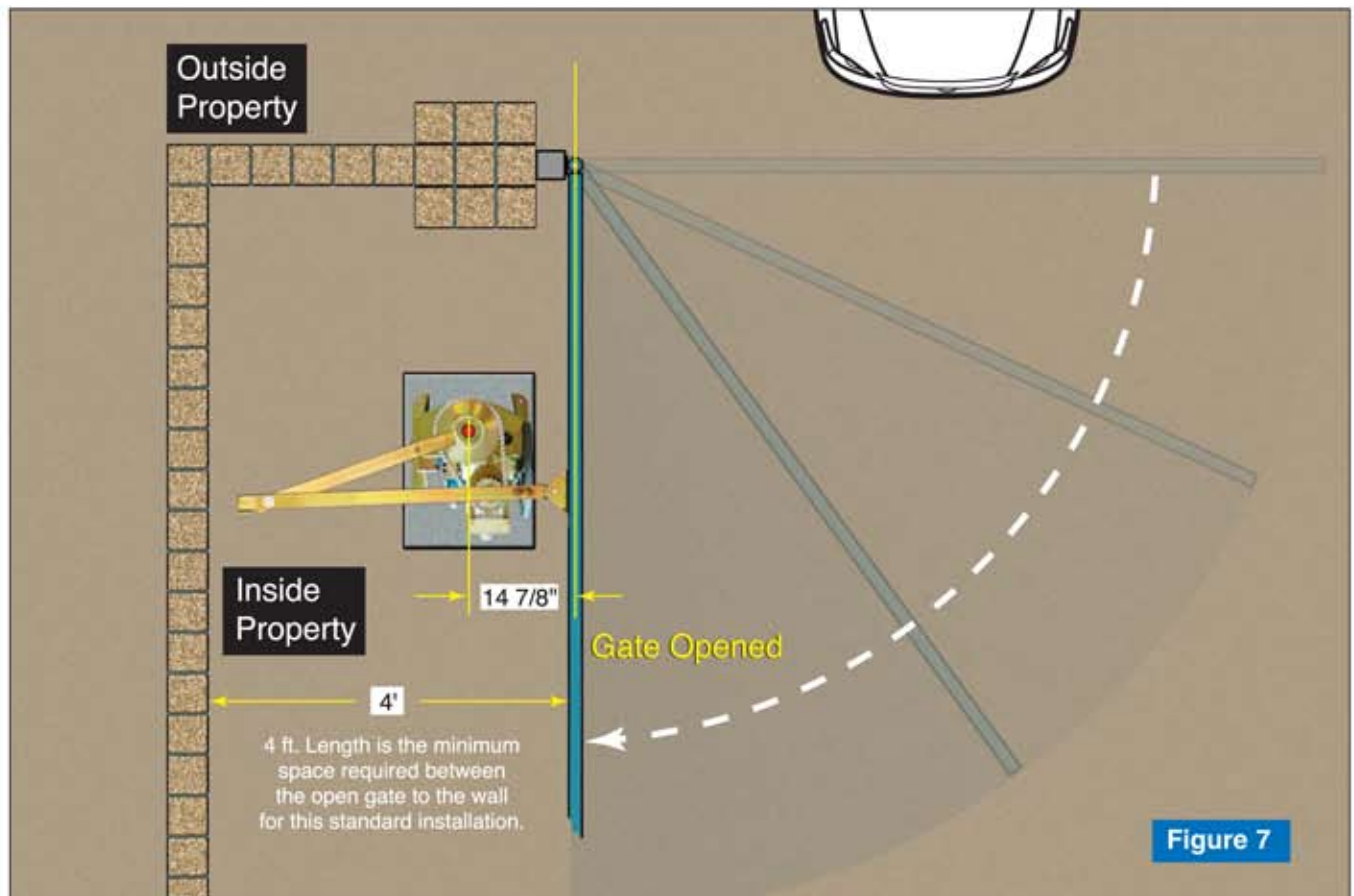

# COMPACT INSTALLATION FOR GATES UP TO 14' IN LENGTH

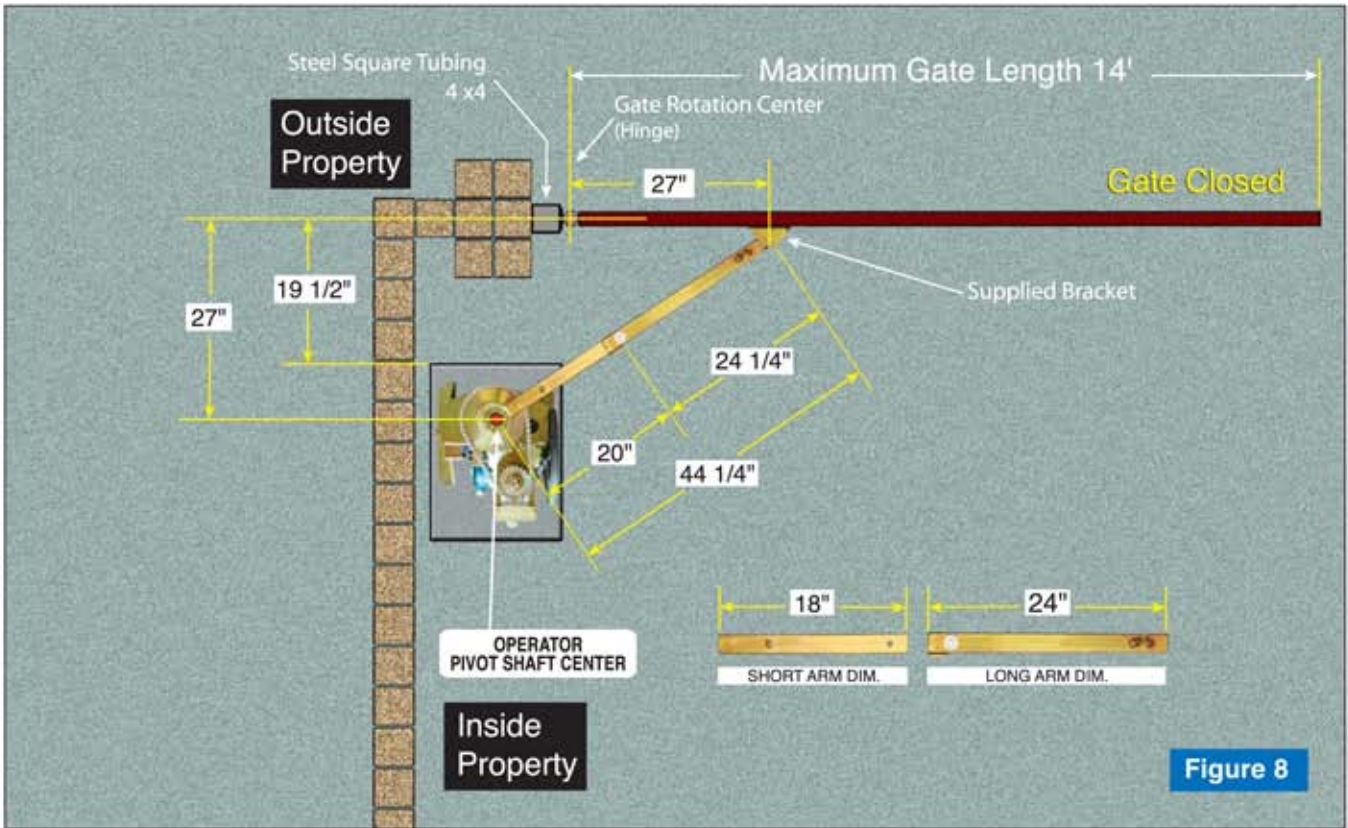

RAM 300

# MINIMUM SPACE REQUIRED FOR COMPACT INSTALLATION

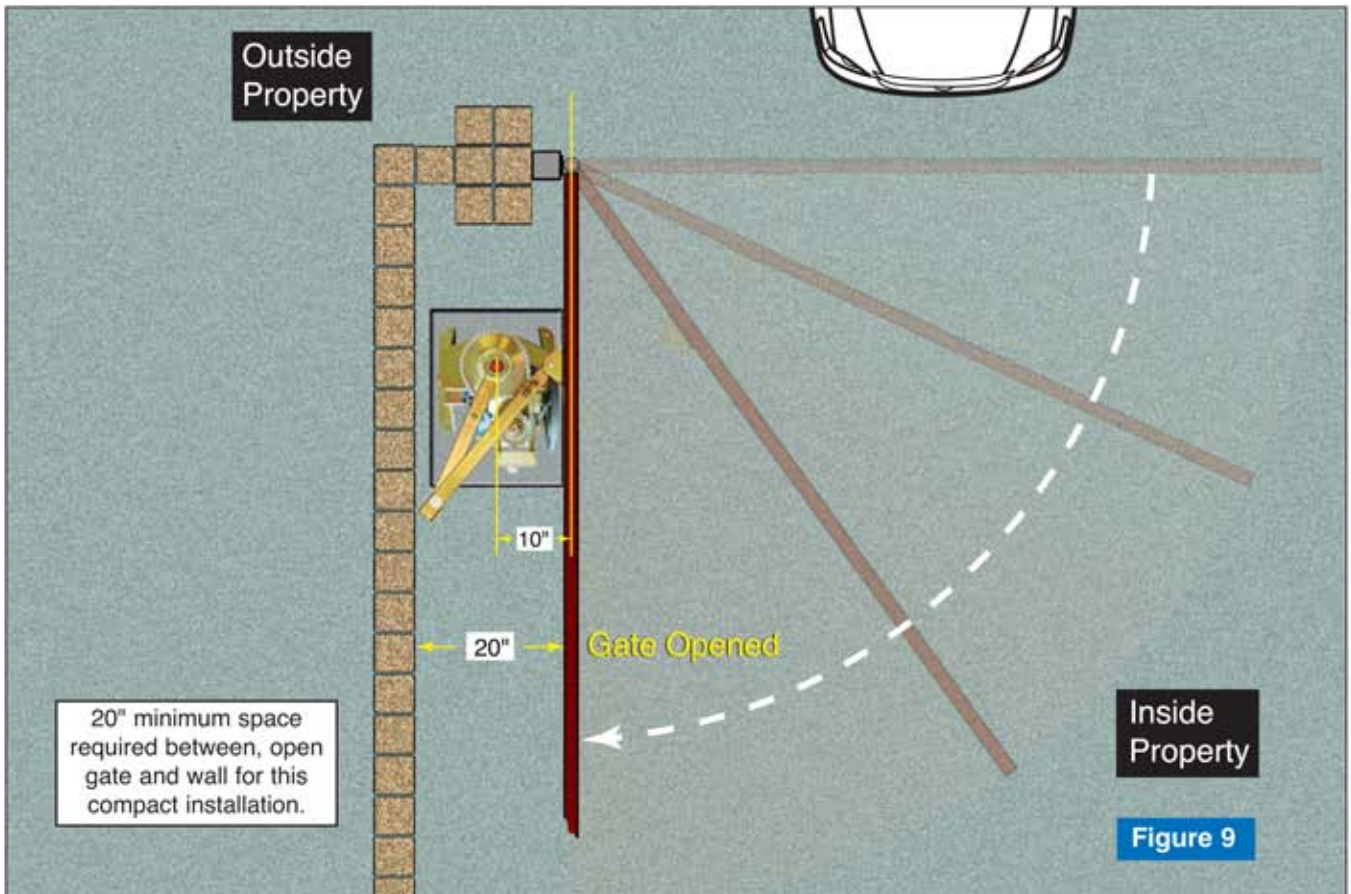



## SENSOR INSTALLATION

Ramset Gate Operators should not be installed without non-contact sensing devices such as Loop Detectors, photo electric sensors or the equivalent.



**WARNING:**

A non-contact sensor (photoelectric sensor or equivalent) and a contact sensor (edge device or equivalent) is required on each individual installation to comply with UL325.

**Reversing Loops** on the ground floor, prevents gate from closing when vehicle is in loop area.

**Exit Loops** on the ground floor, opens gate when vehicle crosses loop area.

**Photoelectric Safety Sensor (Photo Eye)** prevents the gate from closing when any object interrupts the beam.

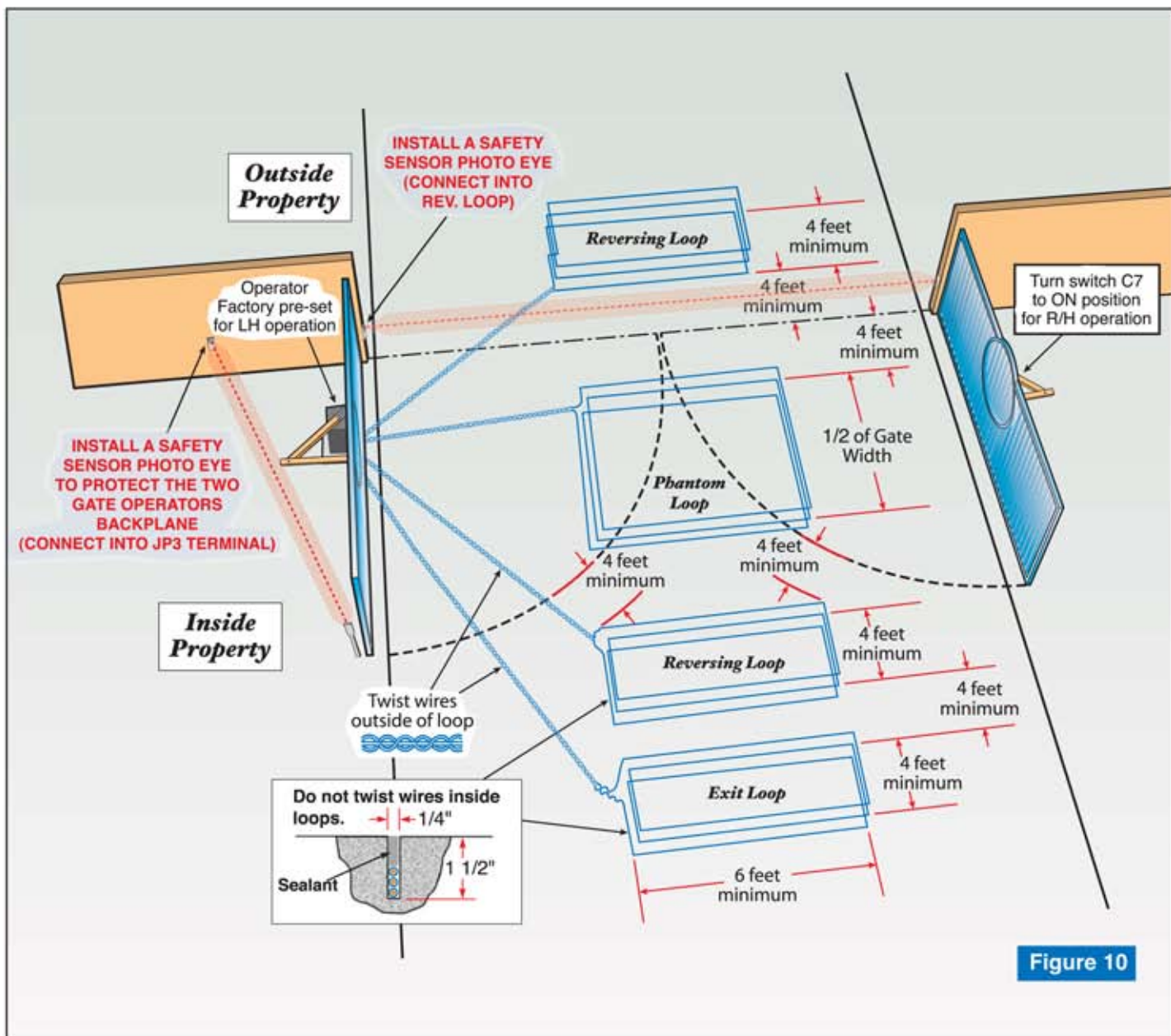

Figure 10

## PUSHBUTTON CONTROLS

Three pushbuttons are located under the dip switches for operation of the gate (see Figure 11). The **opening**, **stop** and **closing** buttons can be utilized to set limit switches and verify proper system operation when installing or servicing an operator.

### Opening

Pressing this button will cause the gate to open.

### Stop

Pressing this button will cause the gate to stop moving.

### Closing

Pressing this button will cause the gate to close.

### Reset E.R.D. Board

Push all three pushbuttons for approximately 5 seconds. All three L.E.D.'s should blink.

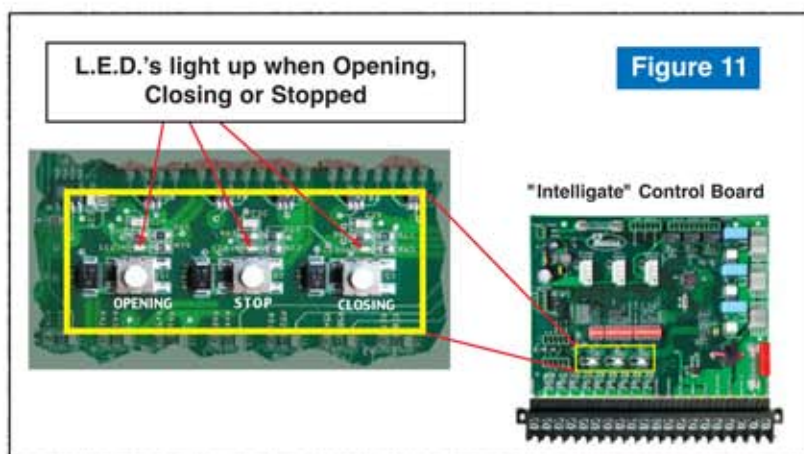

Figure 11

RAM 300

Figure 12

## MASTER / SLAVE INSTALLATION

Set Dip Switch (C8) "Slave Mode" to ON for slave operator.  
 (RH) Right Hand operation requires Dip Switch (C7) "Left/Right" to be ON.

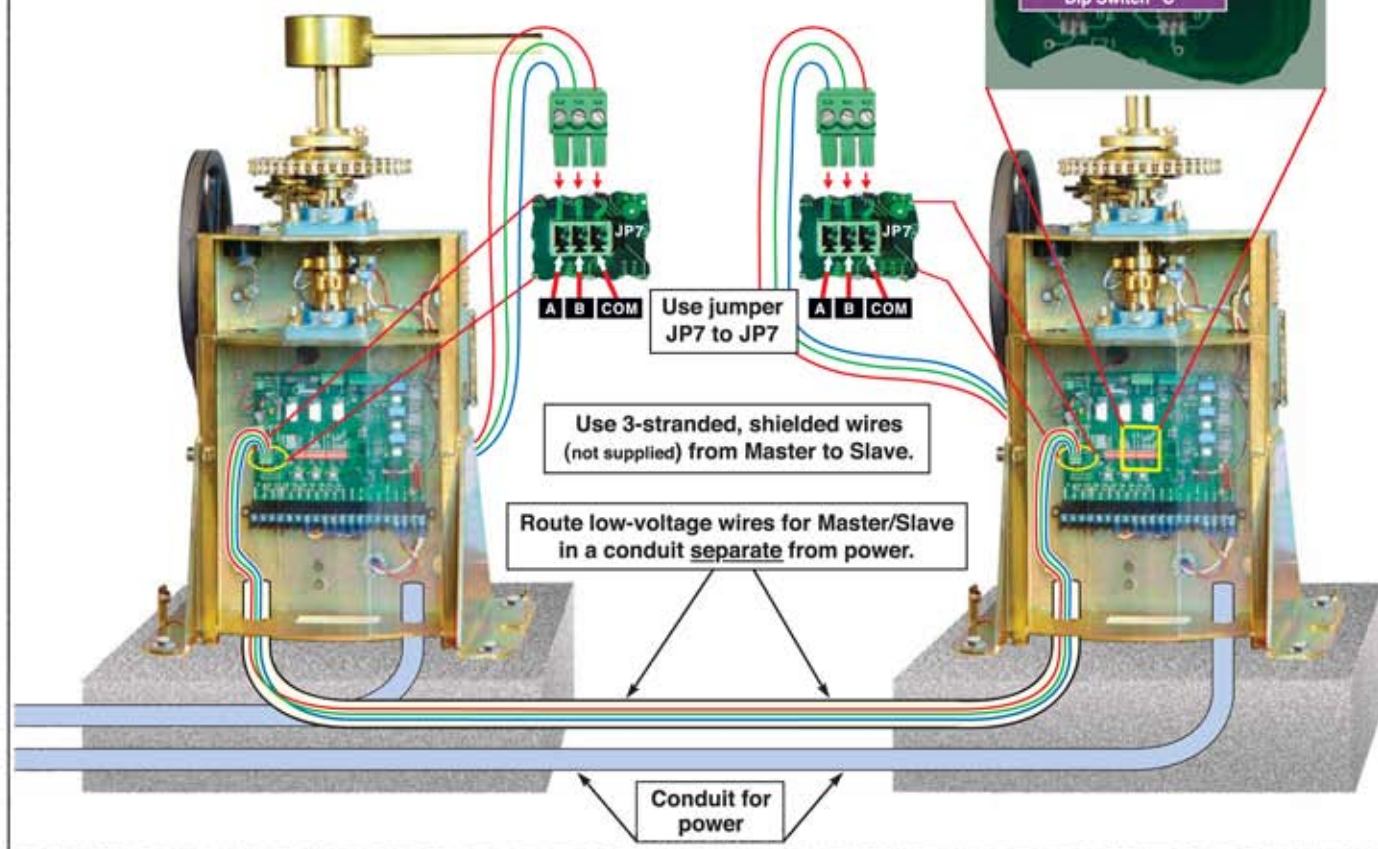



# DIP SWITCH CONFIGURATION

Figure 13

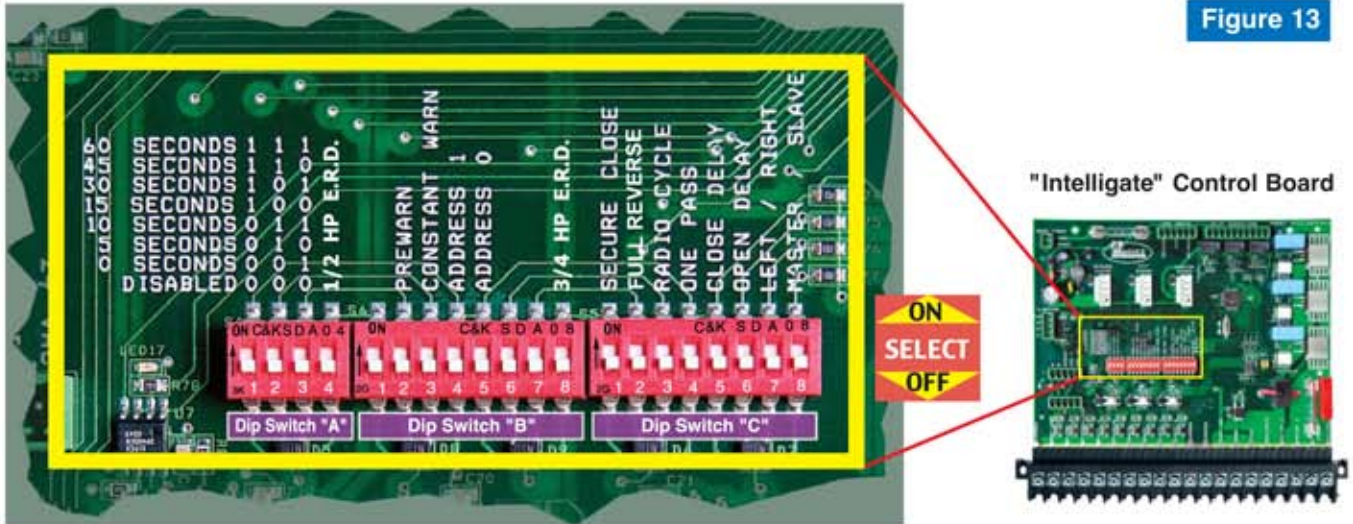

RAM 300

## DIP SWITCH "A"

Dip Switch "A" 1, 2 & 3; AUTOMATIC TIMER TO CLOSE GATE				
'0' is "OFF"		'1' is "ON"		
Switch	1	2	3	Gate Open Duration:
	1	1	1	60 seconds
	1	1	0	45 seconds
	1	0	1	30 seconds
	1	0	0	15 seconds
	0	1	1	10 seconds
	0	1	0	05 seconds
	0	0	1	00 seconds
	0	0	0	disabled - command required to close

Dip Switch "A" 4; 1/2 HP E.R.D.	
Sw.	Function:
OFF	Most sensitive.
ON	Setting for stronger E.R.D. (Less sensitive)

## DIP SWITCH "B"

Dip Switch "B" 1; Not in use at this time.	
Leave in the 'Off' position.	

Dip Switch "B" 2; "PREWARN"	
Sw.	Pre Warning Relay:
OFF	Normal Operation
ON	Adds a 3-second delay before the gate moves in any direction. During This 3 second delay the PREWARN Relay maintains a closed contact.

Dip Switch "B" 3; "CONSTANT WARN"	
(Constant warning when gate is in motion).	
Sw.	Function:
OFF	No effect.
ON	Triggers the prewarn relay to maintain a closed contact while gate is in motion.

Dip Switch "B" 4 & 5; "ADDRESS 1 & ADDRESS 0"			
Up to four separate entrance addresses are available for installations with multiple entrance or exit locations. Master and slave gates that work together should be set to the same address. (Side gates use the address setup)			
Sw.	4	5	Function:
	0	0	Default - Entrance 1
	0	1	Entrance 2
	1	0	Entrance 3
	1	1	Entrance 4

Dip Switch "B" 6; Not in use at this time.	
Leave in the 'Off' position.	

Dip Switch "B" 7; Not in use at this time.	
Leave in the 'Off' position.	

Dip Switch "B" 8; 3/4 HP E.R.D.	
Sw.	Function:
OFF	"Low" E.R.D. for 3/4 hp motors (Most sensitive)
ON	"High" E.R.D. for 3/4 hp motors (Less sensitive)

**DIP SWITCH "C"**

Dip Switch "C" 1; "SECURE CLOSE"	
Sw.	Function:
OFF	Normal Operation
ON	When power is lost, then regained, control board checks status of the gate. If open and safety devices are cleared, gate will close automatically.

Dip Switch "C" 7; "LEFT / RIGHT"	
Sw.	Function:
OFF	Left hand installations - All operators come factory set for left hand operation.
ON	Right hand installations - Reverses motor & limit switches without moving any wires.

**! WARNING:**  
 When installing or servicing an operator, make sure switch "C" 1 is 'Off'. If switch "C" 1 is 'On', the gate will move when power is applied and severe injury may occur.

Dip Switch "C" 8; "SLAVE MODE" Master/Slave configuration	
Sw.	Function:
OFF	Master mode - single gate operation. All peripheral devices are to be connected to the master operator.
ON	Slave mode - used to synchronize operation between two gates. Commands are received from the master through a 3-wire, shielded cable. (Not provided with unit).

Dip Switch "C" 2; Not in use at this time.	
Sw.	Function:
OFF	Normal Operation - When an obstruction is hit in either direction, the gate will reverse for 2 seconds and then stop.
ON	Full Reverse - When an obstruction is hit while closing, the gate will completely reverse to the full open position.

Dip Switch "C" 3; "RADIO CYCLE"	
Sw.	Function:
OFF	Normal Operation - gate only opens and closes on the limit switches. If the gate is in travel then it will always open.
ON	Cycle mode - gate opens and closes on the limit switches, but if in travel, then it will stop with a first command and reverse with a second command.

Dip Switch "C" 4; "ONE PASS"	
Sw.	Function:
OFF	Normal Operation - fully opens and closes
ON	One pass mode - The gate will open until "the reversing loop" is initially activated and then cleared, the gate will then close. If the "reversing loop" is then activated again, before the gate is fully closed, the gate will stop until the "reversing loop" is cleared, then continue to close.

Dip Switch "C" 5; "CLOSE DELAY"	
	One second delay on the closing of the gate.

Dip Switch "C" 6; "OPEN DELAY"	
	One second delay on the opening of the gate.

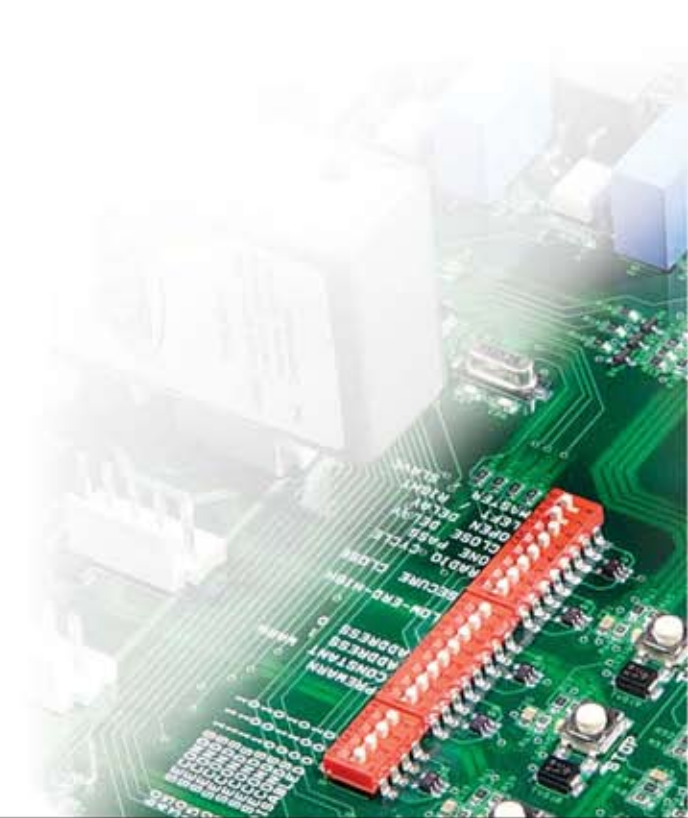



# TERMINAL STRIP CONNECTION FOR OPTIONAL ACCESSORIES

Figure 14

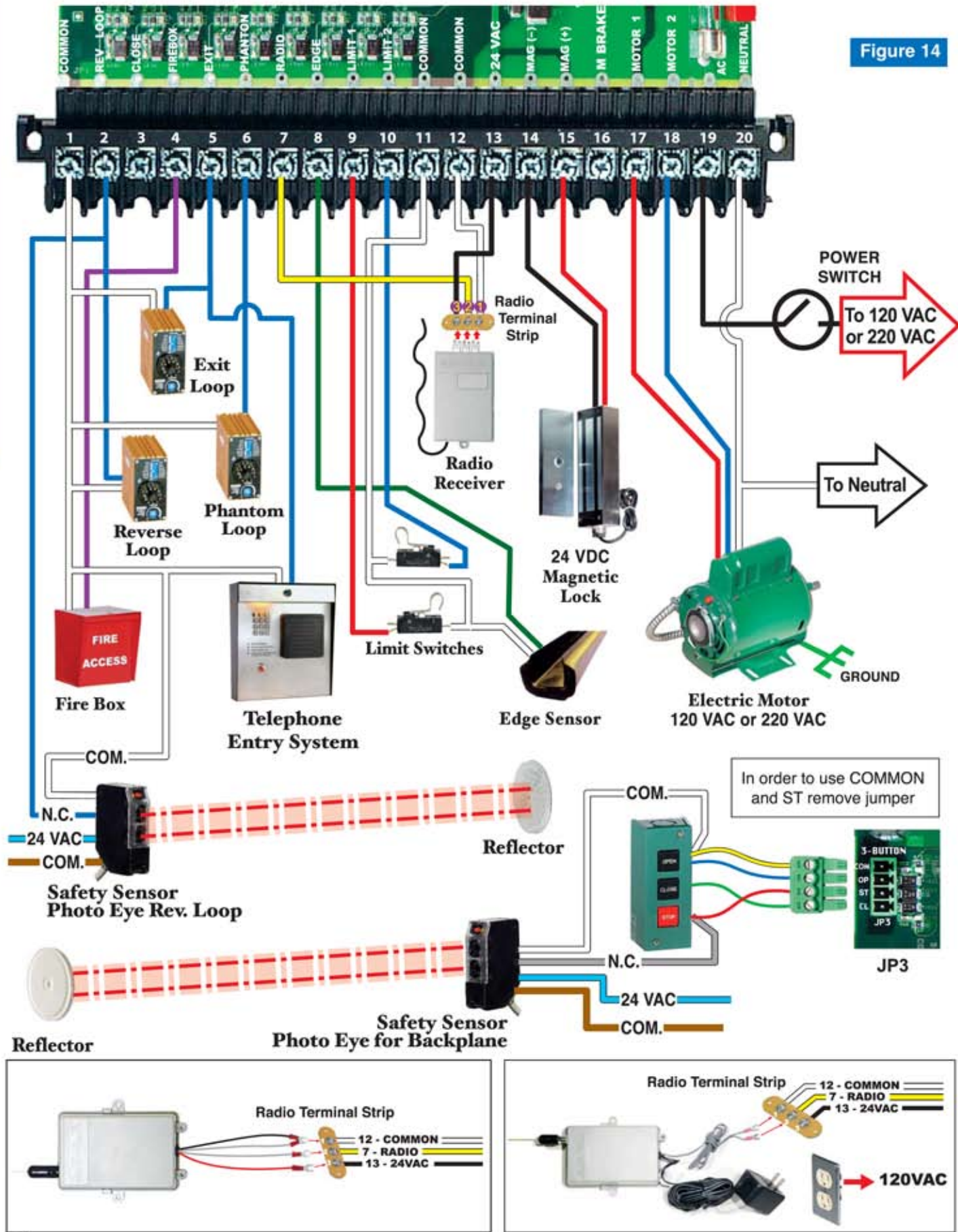

RAM 300

## TERMINAL STRIP CONNECTIONS

### Terminal # 1 - COMMON:

Low voltage common.

### Terminal # 2 - REV LOOP:

Stops the gate from closing. If the gate is open, it holds the gate open. If the gate is closing, it stops and reopens the gate. If the gate is closed, the gate will remain closed. The function can be altered with Dip Switch "C" 4 (see "Dip Switch Configuration"). Used with loop detectors, photo eyes, safety edges...etc. Becomes active with a closed contact to common.

### Terminal # 3 - CLOSE:

Closes the gate. Used with three button stations or pushbuttons. Becomes active with a closed contact to common.

### Terminal # 4 - FIREBOX:

Opens the gate. Used with fire department key switches & controls. Opens with closed contact to common. Closes immediately when closed contact on common is removed.

### Terminal # 5 - EXIT:

Opens the gate. Used with loop detectors, photo eyes, keypads, phone entry systems, three-button stations...etc. Becomes active with a closed contact to common.

### Terminal # 6 - PHANTOM:

Keeps the gate open when the open limit switch is activated. Used with loop detectors. Becomes active with a closed contact to common.

### Terminal # 7 - RADIO:

Operation depends on dip switch "C" 3 (See "Dip Switch Configuration"). Used with an RF receiver or pushbutton. Becomes active with a closed contact to common.

### Terminal # 8 - EDGE:

When triggered the gate will stop. The gate will remain stopped until the detector is cleared. Once the detector is cleared, the operator will resume normal operation. If triggered twice before reaching a limit switch, the alarm will sound for 6 minutes and the control board will not

accept any commands. After the 6 minutes the 24 VDC is removed from the alarm connection and the board resets to normal operation.

### Terminal # 9 and 10 - LIMIT 1 & LIMIT 2:

Direction depends on Dip Switch "C" 7 (See "Dip Switch Configuration"). Stops the motor from moving in one direction. These wires are preset in factory and should not be moved. Becomes active with a closed contact to common.

### Terminal # 11 and 12 - COMMON:

Low voltage common.

### Terminal # 13 - +24 VAC:

Provides 24 VAC for peripheral accessories.

### Terminal # 14 and 15 - MAG (-) & MAG (+):

Supplies 24 VDC to a Magnetic Lock when the gate is closing or closed. If gate is opening or opened, then no power is supplied. Leave open if not used.

### Terminal # 16 - M BRAKE:

Used ONLY on the Ram 50 Operator. If while the gate is closed someone or something tries to manually open the gate without a proper signal (keypad, exit loop, radio signal...), the motor will lock up for 6 minutes. After the 6 minutes, the operator will then secure close the gate.

### Terminal # 17 and 18 - MOTOR 1 & MOTOR 2:

Supplies power to the motor. Direction depends on Dip Switch "C" 7 (see "Dip Switch Configuration"). These wires are preset and connected in the factory and should not be moved.

### Terminal # 19 and 20 - AC HOT & NEUTRAL:

110 VAC or 220 VAC to power the operator. Voltage is predetermined at factory and cannot be changed by the installer or technician.



## RAMSET "INTELLIGATE" CONTROL BOARD

### Introduction:

Ramset's "Intelligate" Control Board works with Sliding, Swinging and Overhead vehicular gate operators. It is controlled by a programmable microprocessor that reads and precisely executes all functions of the Control Board. The Control Board is powered by a separate mounted 24 VAC transformer. This allows no neces-

sary board modifications between 110 VAC and 220 VAC single-phase applications. Some of the functions of the Control Board are: 0 - 60 seconds automatic close timer, self adjusting E.R.D. with low and high setting, constant warning, prewarning, secure close, one pass, open & close delay, left/right hand operation, plug-in loop detectors and RS485 three wire master/slave connection.

Figure 15

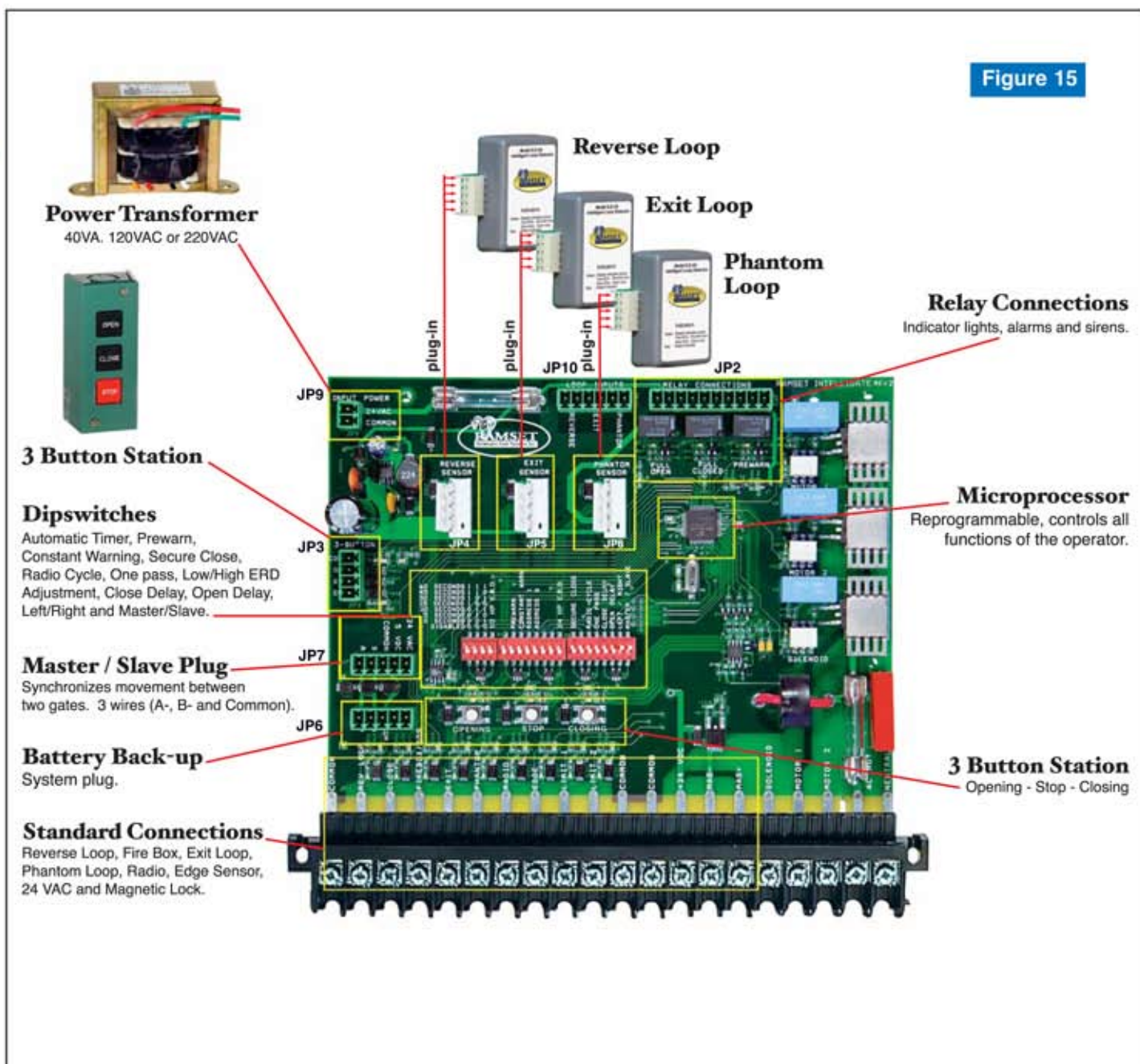

## WIRE BOARD CONNECTIONS



### JP9 - Input Power:

1,2) 24 VAC power.

Connection from external transformer to power Control Board.



### JP3 - 3 Button:

1) Close 2) Stop 3) Open 4) Common

Used with a 3-button station to open, stop, and close the gate. The open and close are normally open connections and the stop is a normally closed connection, remove jumper wire when connecting 3 button station. Common and stop are also used with a photo eye used to protect the back-plane of the operators.



### JP7 - Master/Slave plug:

1) A 2) B 3) Common 4) 5 VDC  
5) 24 VAC.

Used to synchronize the operation between two gates. A three-wire, Shielded cable is needed to run from the A, B, & Common (JP7) of the master P.C.B. to the A, B, & Common (JP7) of the slave P.C.B.



### JP6 - Battery back-up plug:

1) A 2) B 3) Common 4) 5 VDC  
5) 24 VAC.

Use this plug when using optional battery back-up system, Ramset Keypad.



### JP10 - Loop Inputs:

1-2) Reverse 3-4) Exit 5-6) Phantom

Use with ILD-24 Loop wires should be connected to this plug.

### JP4, JP5 & JP8 - Reverse, Exit & Phantom Sensor:

Used with the Ramset ILD-24 plug-in loop detector. The Loop wires should be connected into the "LOOP INPUTS" plug.



### JP2 - Relay Connections:

1) 24 VDC. 5) Relay Common  
2) 24 VAC 6) Fully Closed-N.C.  
3) 5 VDC 7-8) Constant/Prewarn  
4) Fully Open-N.O. 9-10) E.R.D. Alarm.

If E.R.D. is triggered twice before reaching a limit, 24 VDC is supplied to sound an alarm (included with operator).

**Fully Open N.O. (works with relay common) -**  
Relay rated at 125 VAC, 2 amps. Normally open connection. Open contact occurs until the open limit is triggered. When the open limit is triggered, a closed contact occurs.

**Relay Common -** Relay rated at 125 VAC, 2 amps. The common of the Fully Closed N.C. relay and the Fully Open N.O. relay.

**Fully Closed N.C. (works with relay common) -**  
Relay rated at 125 VAC, 2 amps. Normally closed connection. Closed contact occurs until the closed limit is triggered. When the closed limit is triggered, an open contact occurs.





# PARTS DIAGRAM

## RAM 300

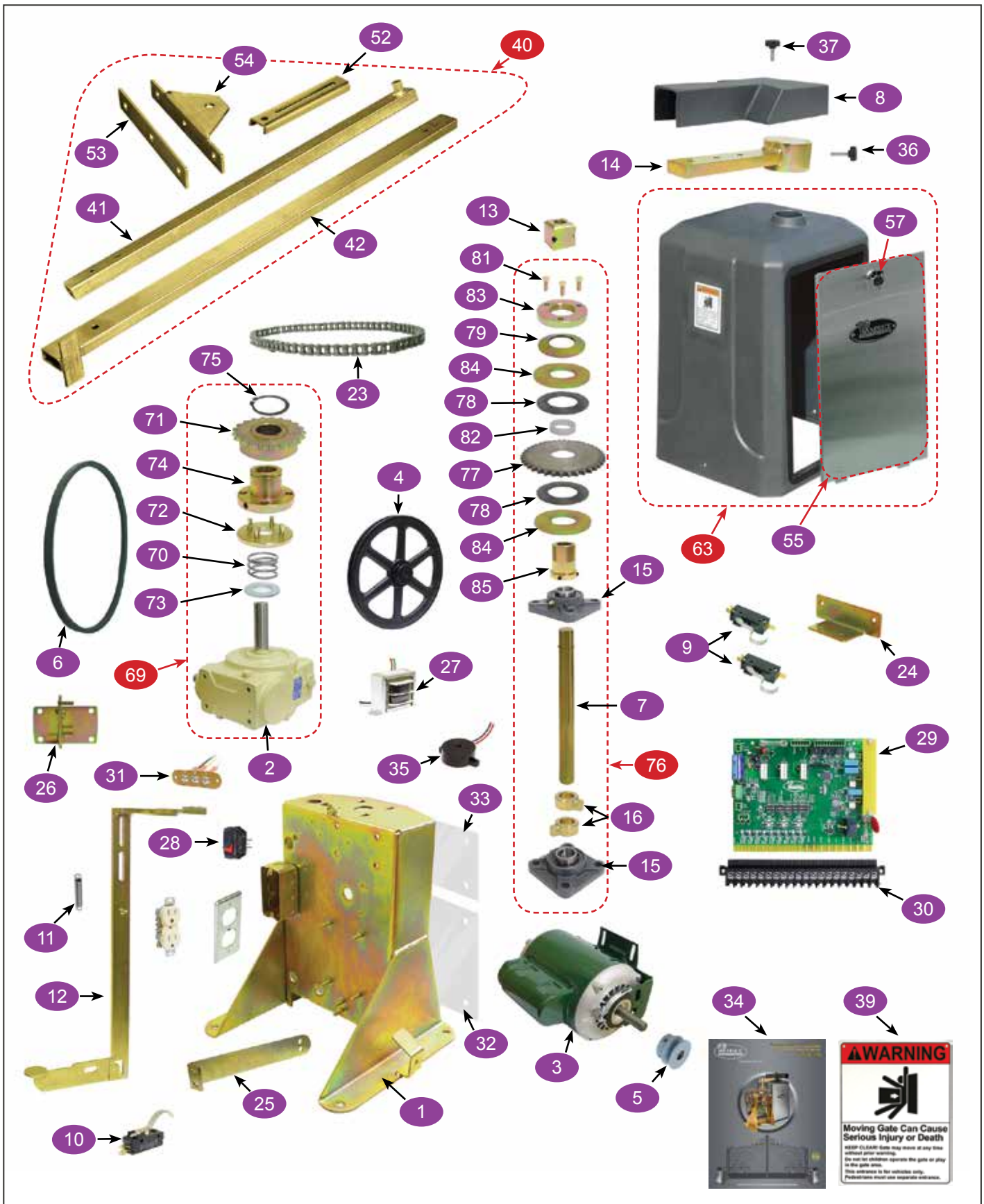

## BILL OF MATERIALS

ITEM	PART #	PART DESCRIPTION	RAM 300
1	800-00-04	Chassis [R300]	1
2	800-02-04	Gear Reducer - Size 50, Ratio 80:1 [R300]	1
3	800-04-10	Motor, Standard - 120VAC 1/2 HP [R5000,R300,R302,R3000s,R2000s]	1
4	800-08-00	Pulley, Cast Iron - 5/8" x 10" (MA100) [R300]	1
5	800-08-45	Pulley, Cast Iron - 5/8" x 2" - AK20 [R300,R3000s,R3030s]	1
6	800-10-06	Belt - 4L-380 [R300]	1
7	800-12-00	Shaft - 1" x 13" [R300]	1
8	800-14-15	Cover, Polyethylene Cap Arm [R300]	1
9	800-20-05	Limit Switch [R300]	2
10	800-20-21	Switch, Foot Pedal [R300]	1
11	800-22-03	Spring - 1/4" x 1" [R300]	1
12	800-24-10	Foot Pedal Release [R300]	1
13	800-28-20	Square Pivot, 1 1/2" - 1" [R300]	1
14	800-28-40	Pivot Arm Release [R300]	1
15	800-44-01	Bearing, Flange - F205 [R300]	2
16	800-48-05	Cam, Limit Switch - 1" [R300]	2
17	800-50-11	Wire Harness - Motor [R300]	1
18	800-50-41	Wire Harness - Outlet [R300]	1
19	800-50-90	Wire Harness - Foot Pedal [R300]	1
20	800-51-03	Wire Harness - Limit Switches [R300]	1
21	800-51-22	Wire Harness - Radio terminal [R300]	1
22	800-51-23	Wire Harness - XFMR to PCB [R300]	1
23	800-52-11	Chain, Drive - #40 - 28 1/2" [R300]	1
24	800-54-50	Bracket, Limit Switch [R300]	1
25	800-55-05	Bracket, Foot Pedal Guide [R300]	1
26	800-55-10	Bracket, Foot Pedal Switch/Lockdown [R300]	1
27	800-60-00	Transformer, 120/240V to 18VAC - 40VA UL	1
28	800-60-10	Switch, Rocker	1
29	800-62-00	Control Board - Intelligate	1
30	800-64-00	Edge Connector - 20 Pin	1
31	800-64-50	Radio Receiver Terminal	1
32	800-66-02	Lexan Control Board Cover [R300]	1
33	800-66-50	Lexan Limit Assembly Cover [R300]	1
34	800-68-04	Instruction Manual [R300]	1
35	800-70-20	Horn Alarm Buzzer	1
36	800-70-35	Knob - 5/16" - 18 x 1 1/2"	1
37	800-70-36	Knob - 5/16" - 18 x 1/2"	1
38	800-70-87	Snap Ring - 1" [R300]	1
39	800-70-98	Warning Sign For Gates - Slide/Swing	2



## BILL OF MATERIALS

ITEM	PART #	PART DESCRIPTION	RAM 300
40	800-75-00	<b>ARM ASSEMBLY</b>	1
41	800-28-00	Arm, Metal Tubing - 1" x 2" x 32" - 12 awg	1
42	800-28-01	Arm, Metal Tubing - 1" x 2" x 42" - 12 awg	1
43	800-28-30	Plastic End Cap - 1" x 2"	2
44	800-36-24	Bolt, Hex Head - 3/8" - 16 x 1 1/2"	4
45	800-36-32	Bolt, Hex Head - 1/2" - 13 x 1 1/2"	1
46	800-36-36	Bolt, Hex Head - 1/2" - 13 x 3"	4
47	800-36-38	Bolt, Hex Head - 1/2" - 13 x 4"	1
48	800-38-76	Nut, Hex Head Nylock - 1/2"	6
49	800-38-74	Nut, Hex Head Nylock - 3/8"	4
50	800-40-29	Washer, Flat - ID 1/2" : OD 1 1/2"	3
51	800-40-27	Washer, Flat - ID 1/2" : OD 1" - F436	4
52	800-54-10	Bracket, Channel - 1 3/4" x 10"	1
53	800-54-30	Bracket, External Gate - 1 1/2" x 12"	1
54	800-54-37	Bracket, Internal Gate`	1
55	800-75-05	<b>ACCESS DOOR ASSEMBLY</b>	1
56	800-16-00	Access Door, Stainless Steel [R300]	1
57	800-18-00	Key, Access Door - #313	2
58	800-18-01	Lock Assembly - 313 Key	1
59	800-32-40	Screw, Machine - #6 - 32 x 3/8" (flat)	2
60	800-38-90	Nut, Hex Head K-Lock - #6	6
61	800-54-03	Bracket, Access Door Z-Type [R300]	2
62	800-70-46	Logo, Plastic	1
63	800-75-11	<b>COVER ASSEMBLY</b>	1
64	800-32-40	Screw, Machine - #6 - 32 x 3/8" (flat)	2
65	800-38-90	Nut, Hex Head K-Lock - #6	14
66	800-70-46	Logo, Plastic	1
67	800-14-04	Cover, Polyethylene [R300]	1
68	800-16-51	Frame, Access Door [R300]	1
69	800-75-22	<b>FOOT PEDAL RELEASE ASSEMBLY</b>	1
70	800-22-01	Spring - 1 1/4" x 3/4" (3 turns) [R300]	1
71	800-06-11	Sprocket, Clutch Release - 41B21H [R300]	1
72	800-24-02	4-Pin Disc [R300]	1
73	800-40-55	Washer, Flat - ID 1 1/16" : OD 2"	2
74	800-58-22	Arbor, Foot Pedal Release [R300]	1
75	800-70-86	Snap Ring, External - 1 1/2" [R300]	1

## BILL OF MATERIALS

ITEM	PART #	PART DESCRIPTION	RAM 300
76	800-75-41	<b>TORQUE LIMITED ASSEMBLY</b>	1
77	800-06-04	Sprocket - 40A40 [R300]	1
78	800-26-01	Friction Disc, Torque Limited - 3 1/2" [R300]	2
79	800-26-10	Tension Washer, Torque Limited - 3" [R300]	1
80	800-34-22	Set Screw - 1/4" - 20 x 3/8"	2
81	800-36-20	Bolt, Hex Head - 3/8" - 16 x 1"	3
82	800-46-30	Bushing, UHMW Sprocket - ID 1 3/4" : OD 2" [R300]	1
83	800-58-02	Arbor Nut, Torque Limited [R300]	1
84	800-58-11	Arbor Washer, Torque Limited - 3 1/2" [R300]	2
85	800-58-31	Arbor, Torque Limited - 1" [R300]	1



## GATE ENTRANCE SAFETY PRECAUTIONS



**WARNING:**

1. Never let children operate or play with gate controls. Keep the controls away from children.
2. The entrance is for vehicles only. Pedestrians should use a separate entrance.
3. Always keep people, children and objects away from the gate while the gate is in operation.  
No one should cross the area of a moving gate.
4. All opening devices, (such as a keypad, cardreader...), should not be installed close to the gate, where the gate could possibly cause injury.
5. Use warning signs attached on both sides of the gate.





Opening the way...

## **Important information for the homeowner**

Ask your technician about all the features of our new Ramset operator.

Safety devices, such as reverse loops, phantom loops, photo eyes, or miller edges must be installed on your gate before the operator may be used. Ask your technician which safety devices best suit your safety needs.

Read your warranty certificate and fill out your warranty extension card. Return the warranty card, via certified mail, to Ramset within 90 days of purchase:

Ramset Automatic Gate Services, Inc.  
9116 De Garmo Ave.  
Sun Valley, CA. 91352

Never let children operate or play with gate controls. Keep the controls away from children.

The entrance is for vehicles only. Pedestrians should use a separate entrance.

Always keep people, children and objects away from the gate while the gate is in operation. No one should cross the area of a moving gate.

Use the emergency release only when the gate is not moving. Make sure when using the foot release or hand crank, the circuit breaker for the operator is turned off.

Have the technician give you a demonstration of how to use the emergency release.

Keep gates properly maintained. Have a qualified gate technician service the gate operator and gate hardware every six months to a year. This includes checking of safety devices, E.R.D. and battery back up systems.

Warning signs must be placed on every gate in a highly visible area.

To reset the audible alarm on the gate operator you must turn the circuit breaker for the operator off for approximately 10 seconds, then back on. An exterior switch or button can also be installed on the operator to shut off the audible alarm.

Always keep a good relationship with your technician and keep his or her number handy for future maintenance or emergencies.

***Ramset wishes to thank you for trusting us  
to meet your gate operator needs.***



## RAMSET OPTIONAL ACCESSORIES



**Mounting Post for Access Control**



**Remote Control Transmitter**

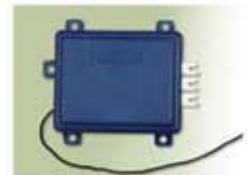

**Radio Receiver**



**Fire Box**  
Emergency Entry Box



**Key Switch Box**



**RAMSET LCD-KP**  
Liquid Crystal Display Keypad



**Ramset Magnetic Lock**



**BBS**  
Battery Back-up System  
(Heavy Duty Industrial)



**RAMSET ILD-24S**  
Plug-in loop detector with sensitivity control



**Uphill Hinges & Uphill Arms**  
To be used under uneven conditions.



**Ramset RPI**  
Maintain all operations of the gate during power outages.