



Programming and Operations Manual

AC Power Supply w/HyInverter AC™

The HyInverter AC Charger offers backup for operators that use AC power



 **HySecurity**®

a company of **TheNiceGroup**

800-321-9947 • 253-867-3700 • www.hysecurity.com

Industrial | Commercial | Crash | Parking | Residential

AC Power Supply with HyInverter AC™

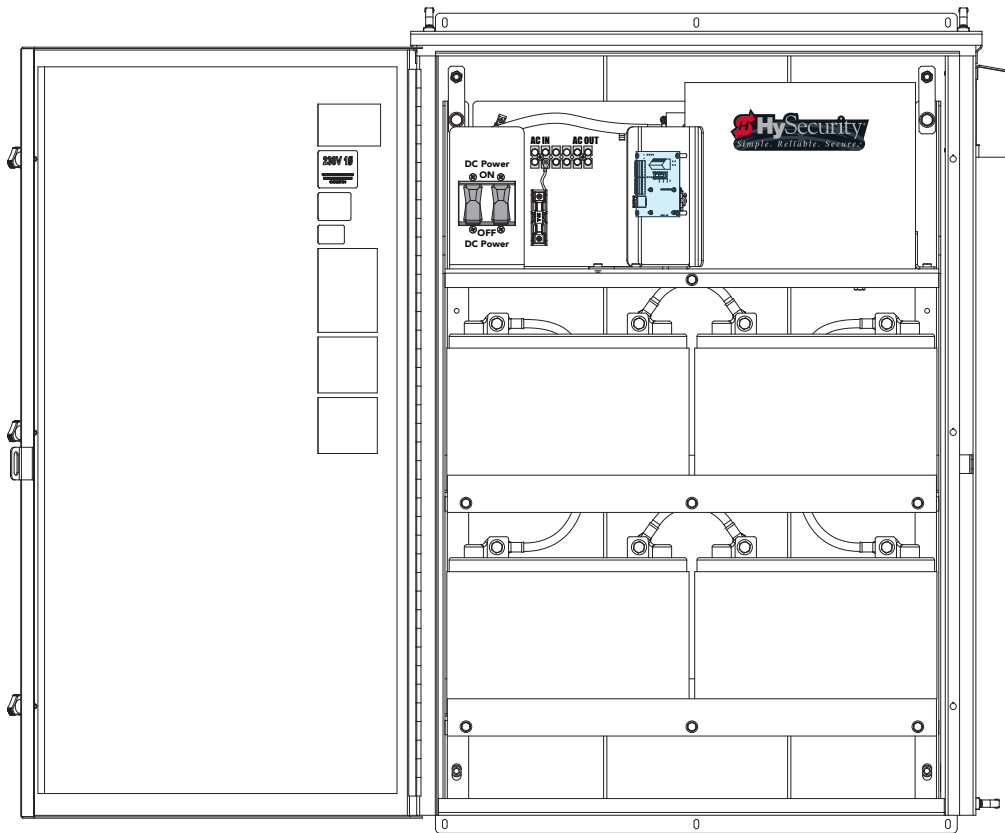

Installation and Reference Manual MX3644-01 Revision E



NEVER connect the AC Power Supply with HyInverter AC™ to life support equipment or as a back up to equipment that may support life. Do **NOT** connect the AC Power Supply with HyInverter AC output to a generator or public power.

This document is a supplemental document that provides *site planning specifications and other references* for the AC Power Supply with HyInverter AC. For important safety considerations and information specific to your gate operator, refer to the HySecurity gate operator's product manuals.

HySECURITY GATE OPERATORS: UL - 2018

Gate operator will not automatically cycle the gate unless an indication that the appropriate number of external entrapment protection sensors are connected and operational.

The normally closed (NC) entrapment protection sensors wired to the Controller's SENSOR inputs are monitored using HySecurity software. Prompts appear on the display requesting specific configurations based on the gate operator type.

The following sensors have been shown in testing to provide the best performance when installed with HySecurity operators. HySecurity supports installers who install these sensors. Other "Compatible Sensors" may meet UL 325 7th

edition requirements but have not been certified for use with HySecurity operators. Contact the sensor manufacturer for specific recommendations for use.

CAUTION

External entrapment protection sensors must have NC sensor outputs and be wired to the SENSOR COM terminal for monitoring and powering purposes. Depending on software version, the sensor becomes powered when the gate operator's motor runs or is always powered when the operator is connected to AC power.

Table 1. Sensors Tested for Use with HySecurity Operators

	Mfg. Part #	Mfg.	Details	Hysecurity Part #
Photo Eyes (Retroreflective)	E3K-R10K4-NR	Omron	40 ft max range limit	MX000999
	NIR-50-325	EMX	45 ft max range limit	
	IRB-RET	EMX	53 ft max range limit	
	E-931-S50RRGQ	Seco-Larm	46 ft max range limit	
Photo Eyes (Thru-Beam)	IRB-MON	EMX	65 ft max range limit	MX3990
	E-960-D90GQ	Seco-Larm	90 ft max range limit	
Edge Sensors	Sentir Series	ASO Safety	Channel mount, high profile Channel mount, low profile Round, wraparound Square, wraparound	AS1502-0440-05 AS1502-0430-05 AS1501-0760 AS1501-0790
	CPT210-2U-#-T2	Miller Edge	10k resistor termination (replace # with length requirement in feet)	
Edge Sensor, Converters (10K to NC Contact)	Hy2NC	HySecurity	2-channel edge converter	MX4018
Edge, Wireless Kits	iGAZE RE Kit	Transmitter Solutions	50 ft line of sight max range limit	
	WEL-200 (kit with receiver and transmitter)	EMX	200 ft line of sight max range limit	
Multi-Input Module	The Solution – MIM-62	Miller Edge	6 inputs to 2 outputs	MX3987

Installers must assess each specific site and install sensors that protect all potential entrapment zones

See HySecurity Gate Operators UL 325 - 2016 Quick Start Supplement for more information

Swing Gate Potential Zones for Entrapment Protection

1. Leading Edge
2. Bottom Edge
3. Entry / Exit
4. Posts
5. Post Pivot / Pinch Points
6. Arm Movement

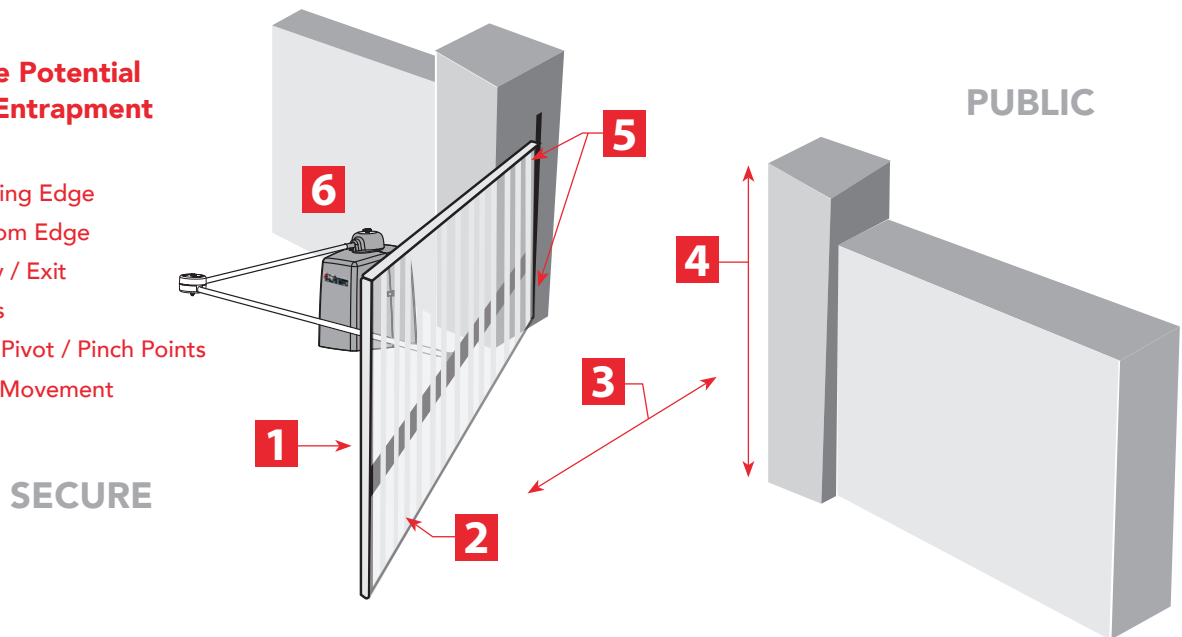

[HySecurity Gate Operators UL 325 - 2016 Quick Start Supplement Page 23](#)

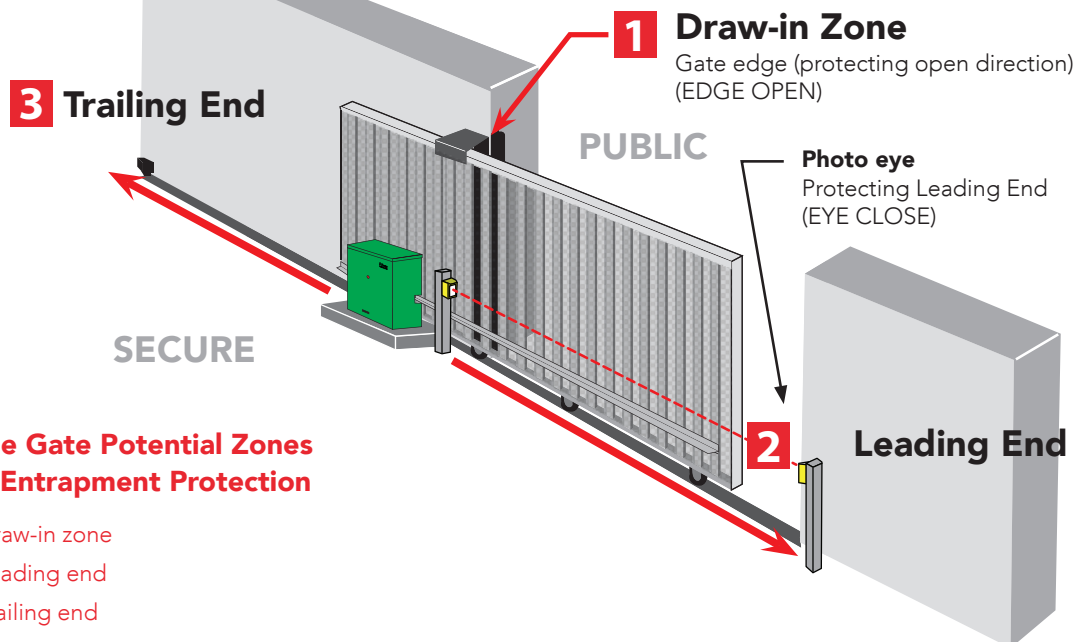

Slide Gate Potential Zones for Entrapment Protection

1. Draw-in zone
2. Leading end
3. Trailing end

[HySecurity Gate Operators UL 325 - 2016 Quick Start Supplement Page 24](#)



1-800-321-9947 • www.hysecurity.com | 1-800-226-0178 • www.niceforyou.us

Manufacturer of ultra-reliable high security, industrial, commercial, residential, parking and crash gate operators and accessories.

D0727

The following bullet points highlight how your automated gate system sites can monitor external entrapment protection using HySecurity gate operators:

- **Normally Closed (NC) sensors** – Before gate movement occurs, the gate operator verifies that the external entrapment protection sensor is connected and fully functional.
- **Build Year (BY)** – An added menu item distinguishes between pre-2016 manufacturing dates, UL 325 - 2016 manufacturing dates, and UL 325 - 2018 manufacturing dates. Build Year (BY) is a factory-setting. Build Year 2 (BY 2) is the default for all HySecurity gate operators indicating a manufacturing date of 1/1/2016 to 7/31/2018 in the serial number. BY 3 is the default for all HySecurity gate operators built after 7/31/2018. Replacement controller boards for existing sites allow for a Build Year setting of 1 (BY 1) (pre-2016).
- **Independent Sensor Inputs** – The edge, photo eye and photo eye COM inputs on the Smart Touch and Smart DC Controllers (STC and SDC) have been re-labeled. The same wiring connections become three independent methods for easy entrapment protection sensor configuration and normally closed outputs.

External Entrapment Protection Sensors monitored by HySecurity Gate Operators

Any external entrapment protection sensor may be monitored by HySecurity gate operators, provided the following requirements are met:

- Sensor is marked as certified to UL 325 Standard of Safety by a Nationally Recognized Test laboratory, such as UL or ETL.
- If the sensor only has a normally open (NO) output with a 8.2K Ω or 10K Ω resistor, such as an edge sensor, then a conversion device must be used to convert the NO resistor output to an NC output. Example of two different installation methods:
 - Method A - Wired
Connect the edge sensor to a NC conversion module (Hy2NC) and connect the module to the operator controls according to the manufacturer's instructions.
 - Method B - Wireless
Connect the edge sensor to a UL 325 certified wireless edge transmitter and connect a matching receiver to the operator controls according to the manufacturer's instructions.

A resource list is available from the drop down [Gate Safety menu](#) on the [HySecurity website](#). The HySecurity recommended list shows examples of external entrapment protection sensors available for NC monitoring of automatic gate operators. All HySecurity gate operators manufactured after January 1, 2016 using software versions h4.50 or h5.50 (or later) comply with UL 325 Standard of Safety for monitoring entrapment protection sensors using normally closed contacts. Slide gate operators built after July 31st, 2018 will require at least one external entrapment sensor in each direction of travel.

The site designer or installer must determine which external entrapment protection sensors will be installed with the gate operator to create a UL 325 compliant automatic gate operator site.

The UL 325 Standard of Safety and ASTM F2200 define the MINIMUM gate site requirements. Gate site, gate hardware, gate usage and other conditions may dictate the use of additional entrapment protection sensors. It is up to the gate system designer and installer to assess appropriate gate safety design and install the components required to protect all potential entrapment zones. Always check your local area codes and comply with all standards and regulations.



Temperatures and environmental conditions affect proper operation of external entrapment protection sensors. Always check the manufacturer's specifications shipped with the sensors. Consult the manufacturer's instructions for correct wiring connections, hardware installation and proper operation.

AC POWER SUPPLY WITH HyINVERTER AC COMPONENTS

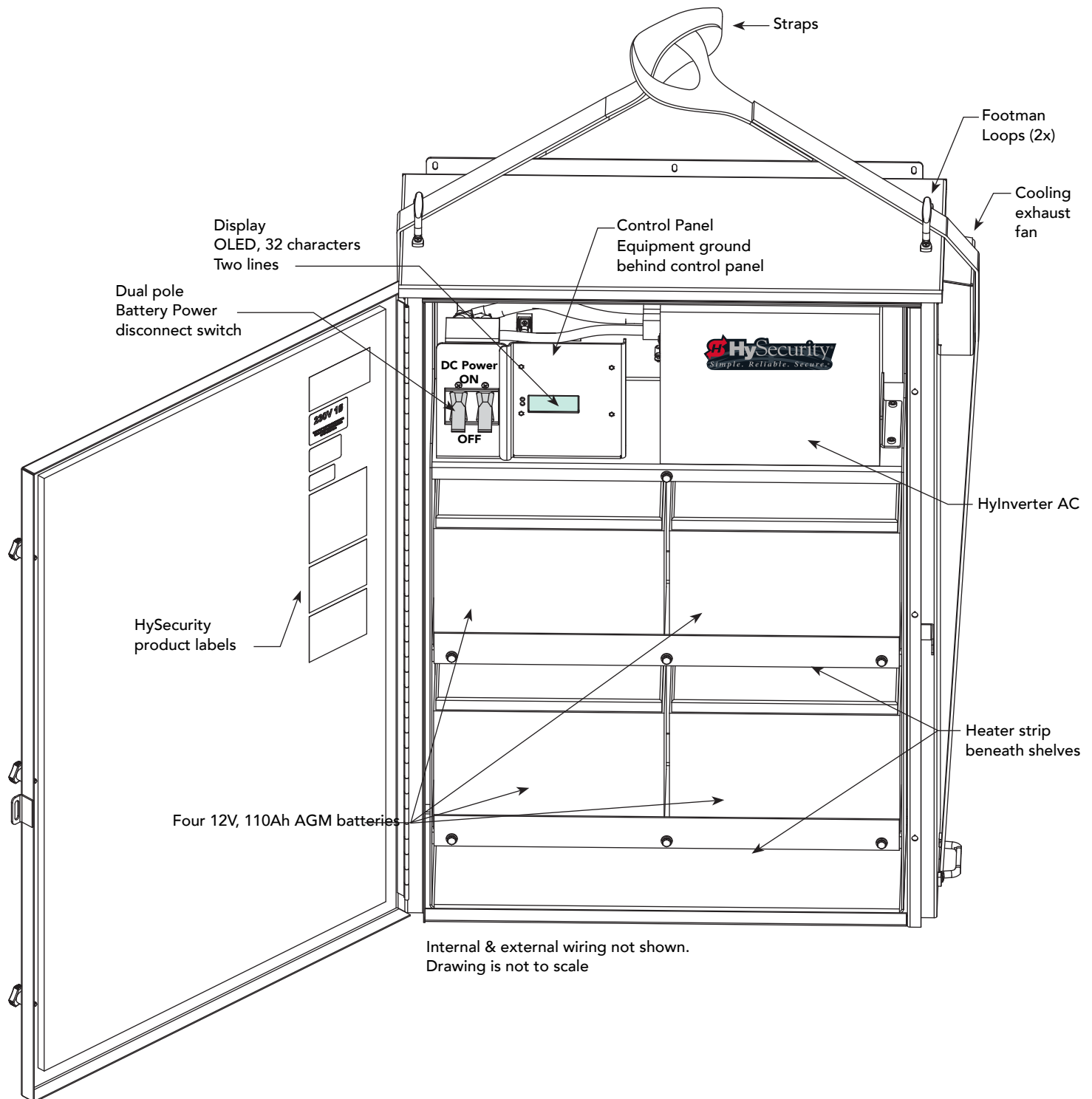

Shipping weight is approximately 520 lbs (236 kg) with batteries.
Use an appropriate crane or hoist lift to move the cabinet into position.

AC POWER SUPPLY WITH HYINVERTER AC POST MOUNT



For additional mounting and installation information, see "Site Overview & Planning" on page 7. Supply cabinet can be either post-mounted or wall-mounted (preferable if inside a building). Both mounts require appropriate supporting structures. See specifications for estimated weight and other considerations.

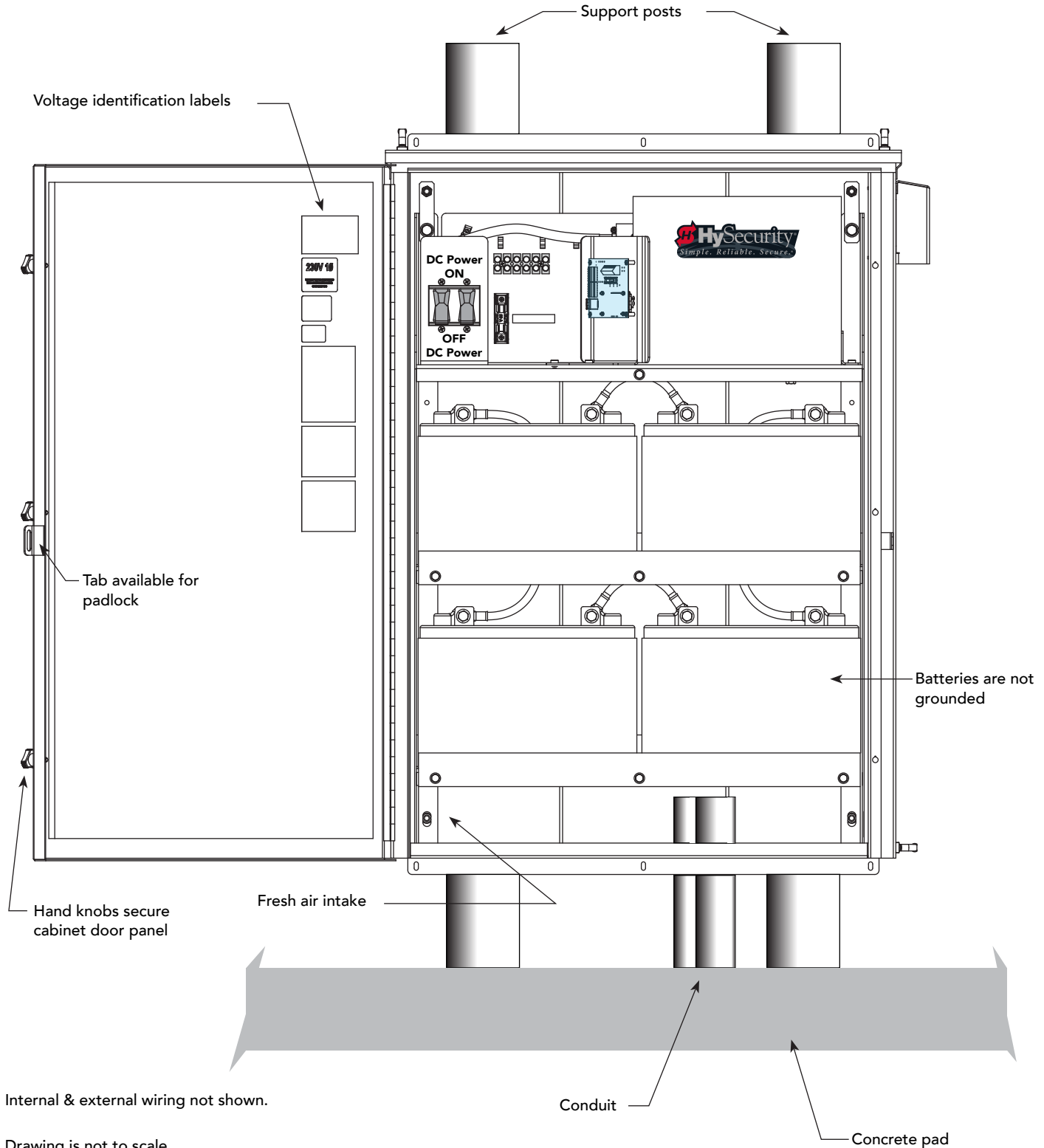

Internal & external wiring not shown.

Drawing is not to scale.

INSTALLER'S CHECKLIST FOR AC POWER SUPPLY WITH HYINVERTER AC

Date Installed: _____

Gate Operator: _____

Site Location: _____

Serial Number: _____

Date Installed AC Power Supply with HyInverter AC: _____

Serial Number: _____

Customer Name: _____

Mailing Address: _____

Inspected by: _____

Date Inspected: _____

Phone Contact: _____

Phone contact number: _____

	Checked	Initials
1. Site Planning Concrete pad poured. Conduit and appropriate wire size installed. Refer to gate operator manual for wire size charts	<input type="checkbox"/>	_____
2. Safety Review <i>Important Safety Information</i> . Warning labels apparent and affixed properly. Area around equipment free of debris, cabinets/chassis include locking mechanism.	<input type="checkbox"/>	_____
3. Electrical 3.1 Measure Input Voltage Single phase: (check all boxes that apply), <input type="checkbox"/> 208V <input type="checkbox"/> 230V <input type="checkbox"/> 50Hz <input type="checkbox"/> 60Hz <input type="checkbox"/> 20A Single phase with VFD: (check all boxes that apply), <input type="checkbox"/> 208V <input type="checkbox"/> 230V <input type="checkbox"/> 50Hz <input type="checkbox"/> 60Hz <input type="checkbox"/> 20A 3.2 Input Power Connections Input power properly connected. L1 and L2 and T1 and T2, Ground wired per illustration on 15. Single phase to gate operator: L1 & L3 3.3 Grounding <ul style="list-style-type: none"> • NFPA 780 Standard for the Installation of Lightning Protection Systems. • Solid copper ground rod (3/8-inch diameter, 10 ft length) driven into ground within 3 ft of the operator. • Single length of unspliced 6AWG copper wire less than 3 ft long attached to lug nut in operator. 3.4 ModBus Wiring between AC Power Supply with HyInverter AC and a HySecurity gate operator (RS-485 communications) <ul style="list-style-type: none"> • Use 18 - 20 gauge twisted and shielded wire, 2 pair. • Connect the ground shield wire to only one piece of equipment, preferably the gate operator. • Install the Drive Board Adapter on the Smart Touch Controller. • Gate operator using Smart Touch Controller must have the most current software loaded. 3.5 Configure the Smart Touch Controller <ul style="list-style-type: none"> • Set the Power Loss function (AP) in the User Menu. See 28. • Access the Installer Menu and select the type of power that the operator uses to AD 3. See 30. 	<input type="checkbox"/>	_____
4. Review gate operator installation checklist	<input type="checkbox"/>	_____
5. Photographs of installation and End User Demo	<input type="checkbox"/>	_____

Contents

HySecurity Gate Operators: UL - 2018.....	iv
External Entrapment Protection Sensors monitored by HySecurity Gate Operators	vi
AC Power Supply with HyInverter AC Components	vii
AC Power Supply with HyInverter AC Post Mount.....	viii
Installer's Checklist For AC Power Supply with HyInverter AC	ix
WELCOME TO HYSECURITY.....	1
Introducing AC Power Supply with HyInverter AC.....	1
Intelligent Features	2
Notices and Bulletins	2
Contact Information	2
Supplemental Documents.....	2
IMPORTANT SAFETY INFORMATION	3
Prevent Electrical Shock	3
Wire, Conductors, and Terminals.....	4
Hazardous Materials and Proper Disposal	4
Emergency Stop and Manual Release.....	5
Safety Notices	5
Common Industrial Symbols	5
Tools Required	6
INSTALLATION	7
Site Overview & Planning	7
Site Overview & Planning: Locations & Connections.....	8
Site Overview & Planning: Installation	9
Gate Site Planning with SlideDriver:	10
SlideDriver: Right Handing Configuration	11
SlideDriver: Left Handing Configuration.....	11
Wire Run and Wire Sizes	12
Battery Safety and Longevity	12
POWER	13
Installing the Earth Ground	13
Wiring AC Power.....	14
Wiring Diagram: 208/230V	15
Establishing the RS-485 Connection	17
Power at Site: Considerations	18
Connecting AC Power Supply with HyInverter AC	18
Connecting Gate Operator AC Power.....	18
AC Power Loss Considerations	18

Turning the Power ON	19
Test the Gate Operator	19
Performance of Gate Operators on Single Phase 50/60Hz	20
DISPLAY & MENU OPTIONS.....	21
Initial Setup	21
Initial Setup Using S.T.A.R.T.	22
Gate Operator Display and Keypad	23
Menu Mode and the STC Keypad	23
Menu Mode Navigation	24
Run Mode and the STC Keypad	24
Viewing Gate Operator Scrolling Status	25
Check Time and Date	25
Stop the STC Status Display Scroll.....	25
Change the Contrast on 7-Segment STC Display.....	25
Display Power Saving Mode	25
Check the Software Version	25
Viewing AC Power Supply with HyInverter AC Display.....	26
AC Power Loss Function: User Menu	27
User Menu: Table 1	28
AP Menu, AC Loss: Table 2.....	28
Installer Menu	29
Installer Menu: Table 3	30
CONTROL PANEL OVERVIEW	31
Control Panel Components: HySecurity Gate Operator	32
STC Board, Power Supply Board and Display.....	33
ModBus RTU	34
AC Loss Relay.....	34
TROUBLESHOOTING	35
STC System Diagnostic Messages	36
GENERAL MAINTENANCE	39
Battery Maintenance	39
Replacing the Batteries	40
Battery Wiring Diagram	41
TN-S Power Distribution System	42
Specifications	44

Welcome to HySecurity

Thank you for your recent purchase of the AC Power Supply with HyInverter AC™. Another superb innovation from HySecurity, Inc., the AC Power Supply with HyInverter AC assures operational integrity at your hydraulic gate site. Inside this manual, you will find an overview for site planning and learn about the power requirements and operational programming available with the AC Power Supply with HyInverter AC system.

For additional safety information and instructions regarding the hydraulic operator powered by the unit, refer to your gate operator's product manual.



HySecurity Gate, Inc. Headquarters in Kent, WA

INTRODUCING AC POWER SUPPLY WITH HYINVERTER AC

The latest offering of a universal power source (UPS) for single phase, 208/230 VAC, 1 hp or variable frequency drive (VFD) hydraulic operators that meets or exceeds ETL requirements and provides unparalleled user benefits:

Smart – Smart charge system using high efficiency switching technology that optimizes battery conditioning, storage capacity and battery life. Modbus RTU communications are provided with the HySecurity gate operator.

Power – Supplies 3000 Watts continuous output to protected devices. Burst mode (up to 6000 Watts for up to 10 seconds) supplies additional energy when needed. 20 A, 208/230 VAC breaker required.

Robust – The electronics and batteries are rated for temperatures ranging from -40°F to 122°F (-40°C to 50°C). Temperature control is a standard feature.

Adaptable - Similar in size to HySecurity HydraSupply cabinets, the AC Power Supply with HyInverter AC unit allows for easy installation with wall mount or post mount adaptability.

INTELLIGENT FEATURES

- Multi-stage charging
- Battery voltage sensing

Fast recharge - After AC power is restored, batteries are completely recharged in as little as 6 hours (12 hours when operating a high-traffic gate).

Temperature control - A heater and fan are standard features and automatically turn on to keep the interior of the cabinet at temperatures that are optimal for maintaining and sustaining a long battery life and charge.

S.T.A.R.T. software and diagnostics - With Smart Touch Analyze and Retrieve Tool software loaded on a PC laptop computer, you have an invaluable management tool for all HySecurity operators. To download this free software, visit the HySecurity website: www.hysecurity.com.

NOTICES AND BULLETINS

Installers should visit the Technical Support page at www.hysecurity.com or contact HySecurity prior to installing product to make sure they have received the most up-to-date information.

CONTACT INFORMATION

Before contacting your distributor or HySecurity Technical Support, obtain the serial numbers from the AC Power Supply with HyInverter AC cabinet and the HySecurity gate operator.

Qualified HySecurity distributors are experienced and trained to assist in resolving any problems. For the name of a qualified distributor near you, contact HySecurity at 800-321-9947.

For information about HySecurity training for installers, maintenance personnel, and end users, refer to the company website at www.hysecurity.com.

SUPPLEMENTAL DOCUMENTS

The product literature is comprehensive and contains information needed to plan, install, operate and maintain the AC Power Supply with HyInverter AC. Additional general information concerning HySecurity hydraulic gate operators is available:

- HySecurity website www.hysecurity.com - Contains links to the product catalog, product order form, operator manuals, operator software downloads, technical support bulletins and other useful information.
- S.T.A.R.T. - Smart Touch Analyze and Retrieve Tool - User's Guide (D0049) detailing the extensive software, diagnostic and troubleshooting capabilities of the Smart Touch controller board and display.
- Technical Bulletins (as applicable).

NOTE: Technical Bulletins are automatically issued to registered users of HySecurity products. The product warranty registration card can be filled out online at www.hysecurity.com.

- This manual is a supplement to the gate operator. Read and follow the *Important Safety Information* found in the gate operator's *Programming and Operations Manual* as well as the *Important Safety Information* found in this gate operator product manual supplement.

IMPORTANT SAFETY INFORMATION

SAVE THESE INSTRUCTIONS

This manual contains important instructions for the AC Power Supply with HyInverter AC that should be followed during installation and maintenance of the AC Power Supply with HyInverter AC and its batteries.



Read all the product safety information prior to installation. Automatic gate operators move the gate with high force and can cause serious injury and death! Make sure the automatic gate operator is installed to reduce the risks of entrapment. Verify the gate operator is installed to comply with all safety standards and local and federal regulations.

Understand that you as the site designer, installer, maintenance crew, or owner/user must consider the risks associated with the AC Power Supply with HyInverter AC (inverter/charger) and gate operators. Be sure to take responsibility, read, and follow the *Important Safety Information* found here and in the gate operator's manual and review all the literature that accompanies the product.

Hazards, associated with automatic gates, can be reduced with proper site design, installation, and use. It is important that only qualified installers handle the installation of the HySecurity equipment.

A "qualified" installer has one of the following:

- A minimum of three years experience installing similar equipment
- Proof of attending a HySecurity Technical Training seminar within the past three years
- Significant manufacturer endorsements of technical aptitude in gate operator installation and operation

Underwriter Laboratories (UL) and the American Society for Testing and Materials (ASTM) are responsible for current safety standards and regulations regarding automatic vehicular gate operators. To pass certification, all aspects of gate operator and gate installation must comply with the appropriate safety standards.

For the most up-to-date ASTM F2200 Gate and Fence Standards, refer to www.astm.org

For UL 325 Safety Standards and UL 1778, refer to www.ul.com

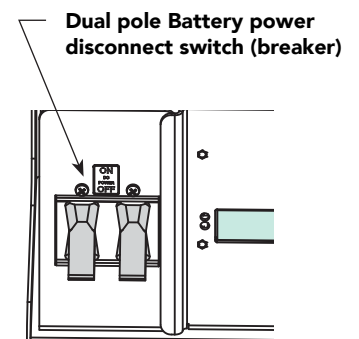

Prevent Electrical Shock

To stop the flow of electricity, turn off power at the breaker found in the AC Power Supply with HyInverter AC cabinet. The power disconnect switch only disconnects power to the batteries. If you are performing routine maintenance or more extensive repairs always be sure to turn OFF the main AC power to the gate operator and AC Power Supply with HyInverter AC. For additional information, refer to "Battery Safety and Longevity" on page 12.



Residual amounts of electricity reside in the batteries even when the AC power switches are turned off. If shorted, the batteries can deliver very high currents. Exposed connector pins must be handled with extreme care and caution; they can be easily shorted against any metal surface. If a short circuit persists beyond a second, connectors, cables, and tools can be damaged or destroyed. Fire and personal injury may result and potential for electrical shock exists. Be sure to remove any metal (rings, jewelry, tools, etc.) and any conductive products from your person before servicing or working near the AC Power Supply with HyInverter AC.

Wire, Conductors, and Terminals

When installing the AC Power Supply with HyInverter AC, use only copper conductors with a minimum 12 AWG wire size and a minimum temperature rating of 167° F (75° C). Refer to the “Wiring Diagram: 208/230V” on page 15.

Pressure terminal connectors are used in the AC Power Supply with HyInverter AC and the clamping screws must be torque tightened to **3.5 N•m (2.6 lb•ft or 41 oz•ft)**.

HAZARDOUS MATERIALS AND PROPER DISPOSAL

Be aware of the international, federal, and local codes in your area and how best to handle hazardous waste materials.

AC Power Supply with HyInverter AC uses sealed, state-of-the-art Absorbed Glass Mat (AGM) batteries and **requires** replacing used batteries with new AGM-type batteries.



The AGM batteries contain materials that are considered hazardous to the environment. Proper disposal of each battery is required by federal law. In the U.S.A., refer to federal EPA guidelines for proper hazardous waste disposal.

To reduce the risk of fire or injury to persons using vented batteries, such as the AGM batteries found in AC Power Supply with HyInverter AC:

- Observe the polarity between the batteries and charging circuit.
- Never mix battery sizes, types, or brands. Only sealed AGM style batteries should be used.
- Exercise care in handling batteries. Be aware that the metal found in rings, bracelets, and keys can conduct electricity, short the batteries, and cause potential injury. Remove metal objects from your person before working or handling items in the AC Power Supply with HyInverter AC cabinet.
- Do not open or mutilate the batteries. Battery cells contain corrosive materials which may cause burns and other injuries. The material within batteries is toxic and considered hazardous waste material.
- Always dispose of batteries properly. Do NOT place batteries in fire. The battery cells may explode. Follow federal guidelines for proper disposal of hazardous waste.
- Replace batteries according to the instructions found in *Battery Replacement*.



To reduce the risk of fire, connect only to a circuit provided with a 20A breaker, a maximum branch circuit overcurrent protection in accordance with the National Electrical Code, ANSI/NFPA 70 and the Canadian Electrical Code, Part 1, C22.1.

EMERGENCY STOP AND MANUAL RELEASE

No emergency stop or manual release is found in the AC Power Supply with HyInverter AC cabinet. For other HySecurity gate operator's, the emergency stop button is strategically placed on the outside of the gate operator (or HydraSupply cabinet) and its manual release location is dependent on the type of gate operator. Refer to the gate operator's product manual for more information.

SAFETY NOTICES

The following four levels of safety notices are used where applicable within this manual; each notice contains information specific to the situation.



Indicates death or serious injury will occur if the hazardous situation is not avoided.



Indicates death or serious injury could occur if the hazardous situation is not avoided.



Indicates mild or moderate injury could occur if the hazardous situation is not avoided.

NOTICE: Indicates damage to equipment is probable if the hazardous situation in not avoided.

COMMON INDUSTRIAL SYMBOLS

The following international safety symbols may appear on the product or in its literature. The symbols are used to alert you to power issues and potential personal injury hazards. Obey all safety messages that follow these symbols to avoid possible injury or death.

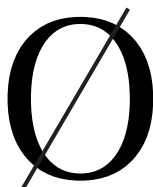

**Electrical Phase
Symbol**

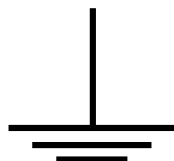

**Ground
Symbol**



**- Danger -
Keep Away**



**Entrapment
Zone**



**Possible
Pinch Point**



**Attention
- Take Note -**

SAVE THESE INSTRUCTIONS

TOOLS REQUIRED

- Standard socket set ($\frac{9}{16}$ -inch combo wrench, $\frac{7}{16}$ -inch socket wrench, two $\frac{7}{16}$ -inch box end wrenches)
- Crescent wrench
- Flat head screwdriver
- Wire cutter and wire nuts

Gate operators equipped with the AC Power Supply with HyInverter AC option are powered by four 12-Volt, 110Ah DC batteries which, when AC power loss occurs, maintain a true Uninterrupted Power Supply (UPS) system. When the local AC power fails, the UPS back up system continues to move the gate. System features are covered in “Introducing AC Power Supply with HyInverter AC” on page 1. See specifications on the back cover for backup gate travel capacity.

NOTICE: The AC Power Supply with HyInverter AC option is intended for single phase (1 hp) gate operators and single phase (2 hp) gate operators that use Variable Speed Drives (VFD).

SITE OVERVIEW & PLANNING

NOTE: In the example shown on the next page, the length of conduit and wire size is dependent on location of AC Power Supply with HyInverter AC cabinet. Information about wire size and runs is found in the Programming & Operations Manuals for the particular gate operator installed.

- Locate concrete footings a minimum of 16 inches (41 cm) deep or to frost line per local codes.
- At minimum, use 4-inch (10 cm) diameter support posts for supply cabinet. Support posts and hardware are not provided by HySecurity. Neither is wall mounting hardware.
- The AC Power Supply cabinet can be wall-mounted, post-mounted, or preferably placed in a building.
- Place the AC Power Supply with HyInverter AC anywhere between the main breaker panel and the gate operator. Refer to your operator’s product manual for proper wire sizing and wire run distances. Provide conduit for wires.
- A 20A circuit breaker for the branch power to the AC Power Supply with HyInverter AC must be provided in the field.
- A readily accessible disconnect switch must be provided in the field for the AC output from the AC Power Supply with HyInverter AC.



In the following pages the AC Power Supply with HyInverter AC and SlideDriver illustrations are for installation reference only. Site configurations vary depending on the equipment used. For an overview of locations and connections from the AC Power Supply with HyInverter AC to the HySecurity gate operator, see “Site Overview & Planning: Locations & Connections” on page 8.

SITE OVERVIEW & PLANNING: LOCATIONS & CONNECTIONS

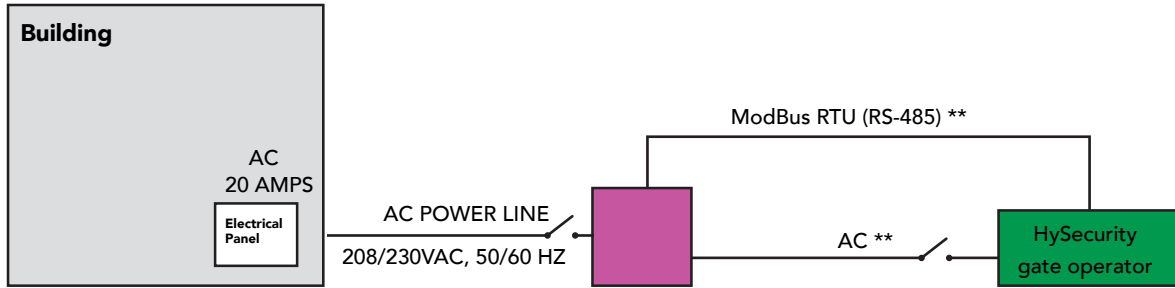

All connections Single Phase (Ø)

NOTICE:

- A 20A circuit breaker for the branch power to the AC Power Supply with HyInverter AC must be provided in the field.
- A readily accessible disconnect switch must be provided in the field for the AC input and output from the AC Power Supply with HyInverter AC.

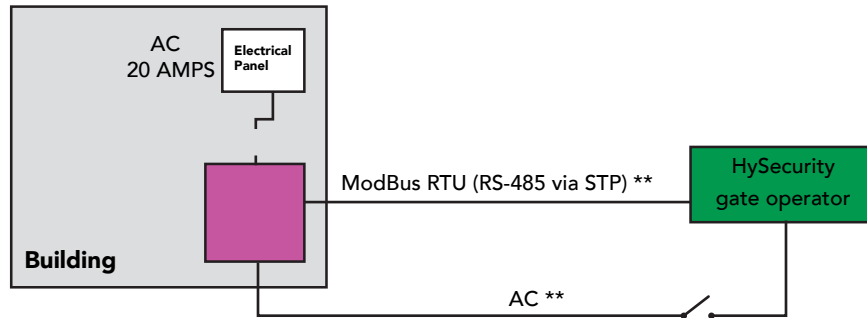

Possible locations of AC Power Supply with HyInverter AC with Respect to the Gate Operator

** Connection = AC Power Supply with HyInverter AC to HySecurity hydraulic gate operator.

For AC Input, 3 wires (see wire size and run charts)

- For ModBus RTU, 4 wires stranded or shielded twisted pair (STP).

For a battery wiring diagram, see "Replacing the Batteries" on page 40.
For ModBus and external wiring diagram, see .

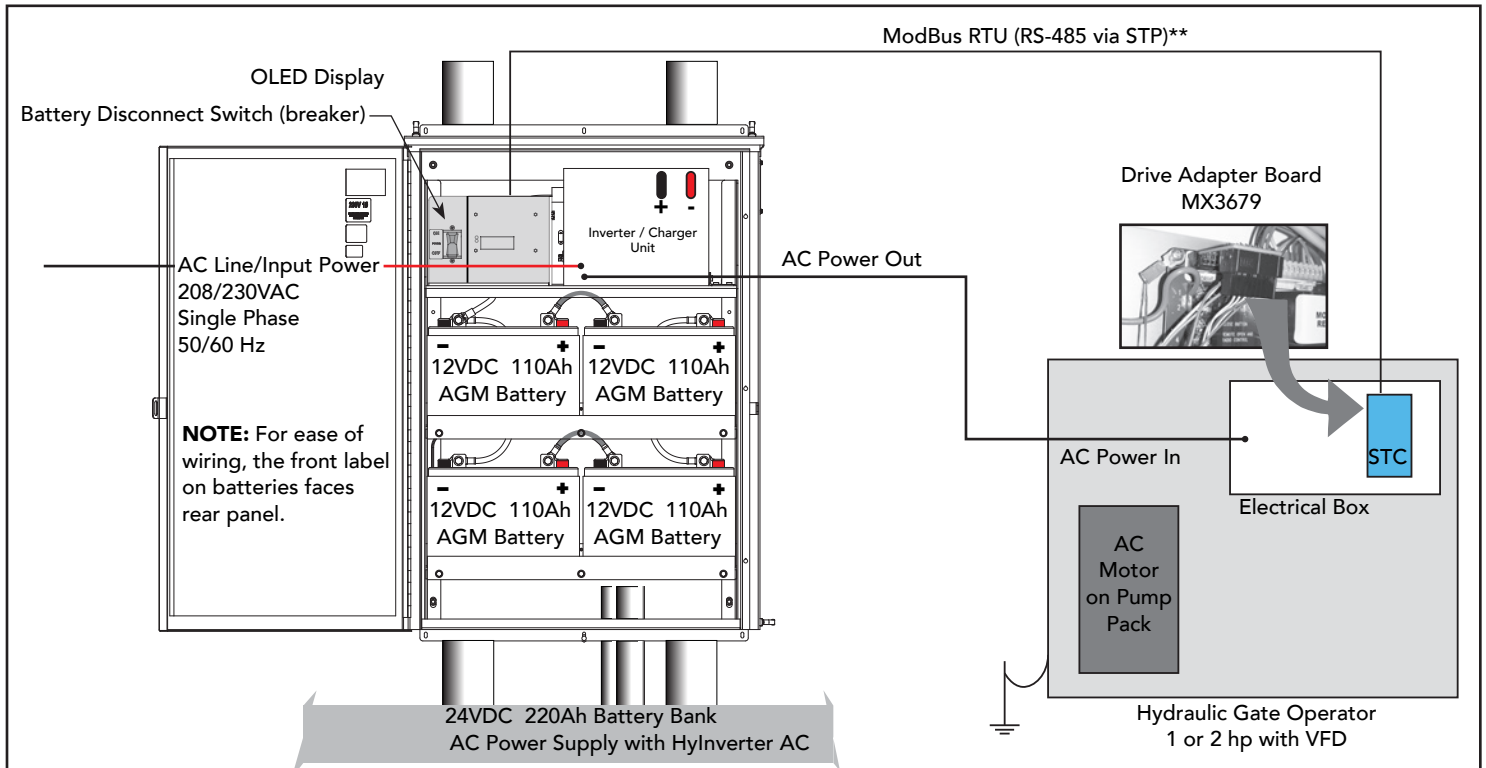

**AC Power Supply with HyInverter AC Connections to Hydraulic Gate Operator
Single phase (1Ø), 1 hp or 2 hp with VFD**

SITE OVERVIEW & PLANNING: INSTALLATION

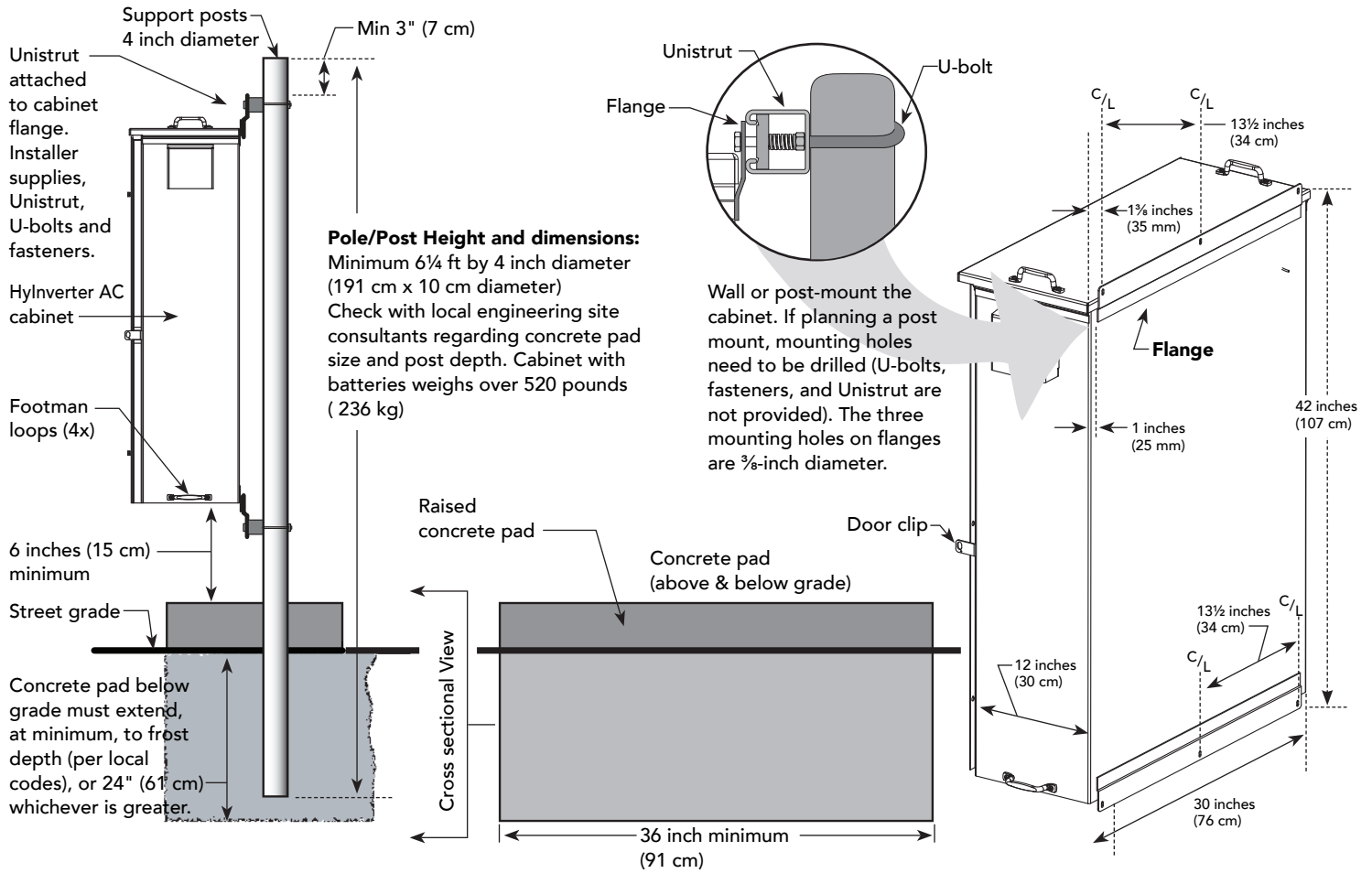

AC Power Supply with HyInverter AC Cabinet

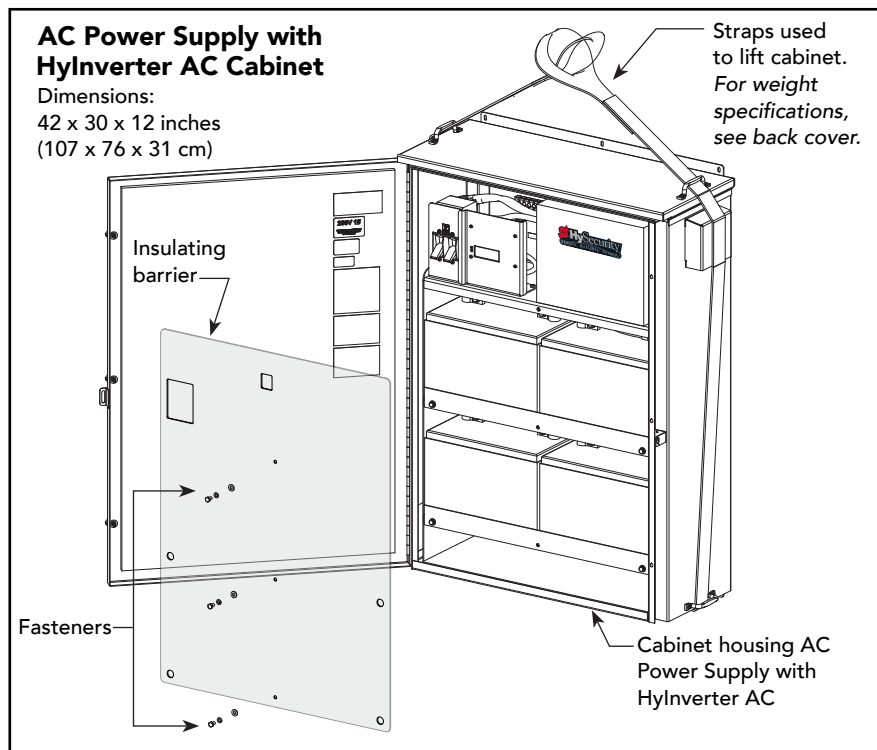

Insulating Barrier and AC Power Supply with HyInverter AC Cabinet

GATE SITE PLANNING WITH SLIDEDRIVER:

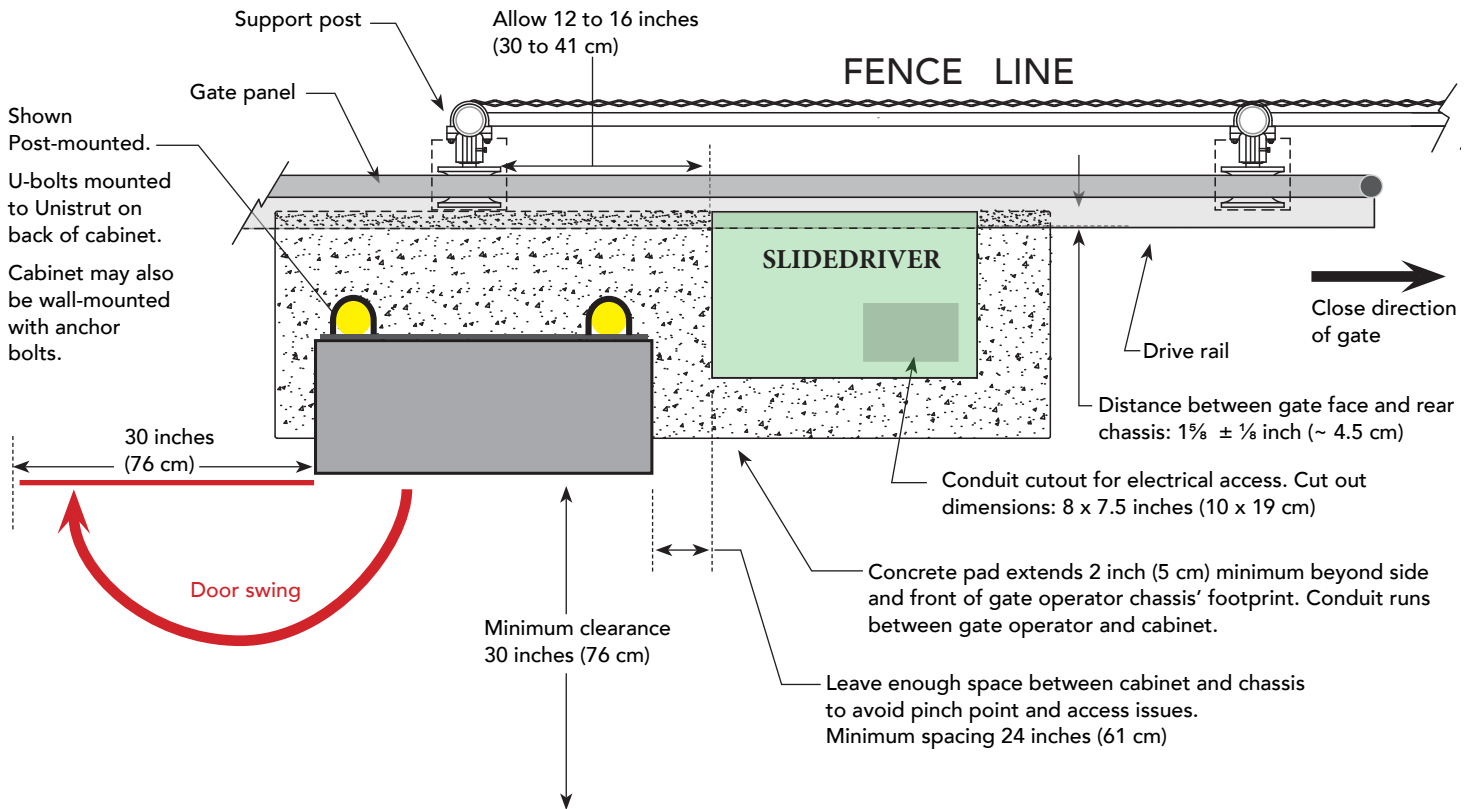
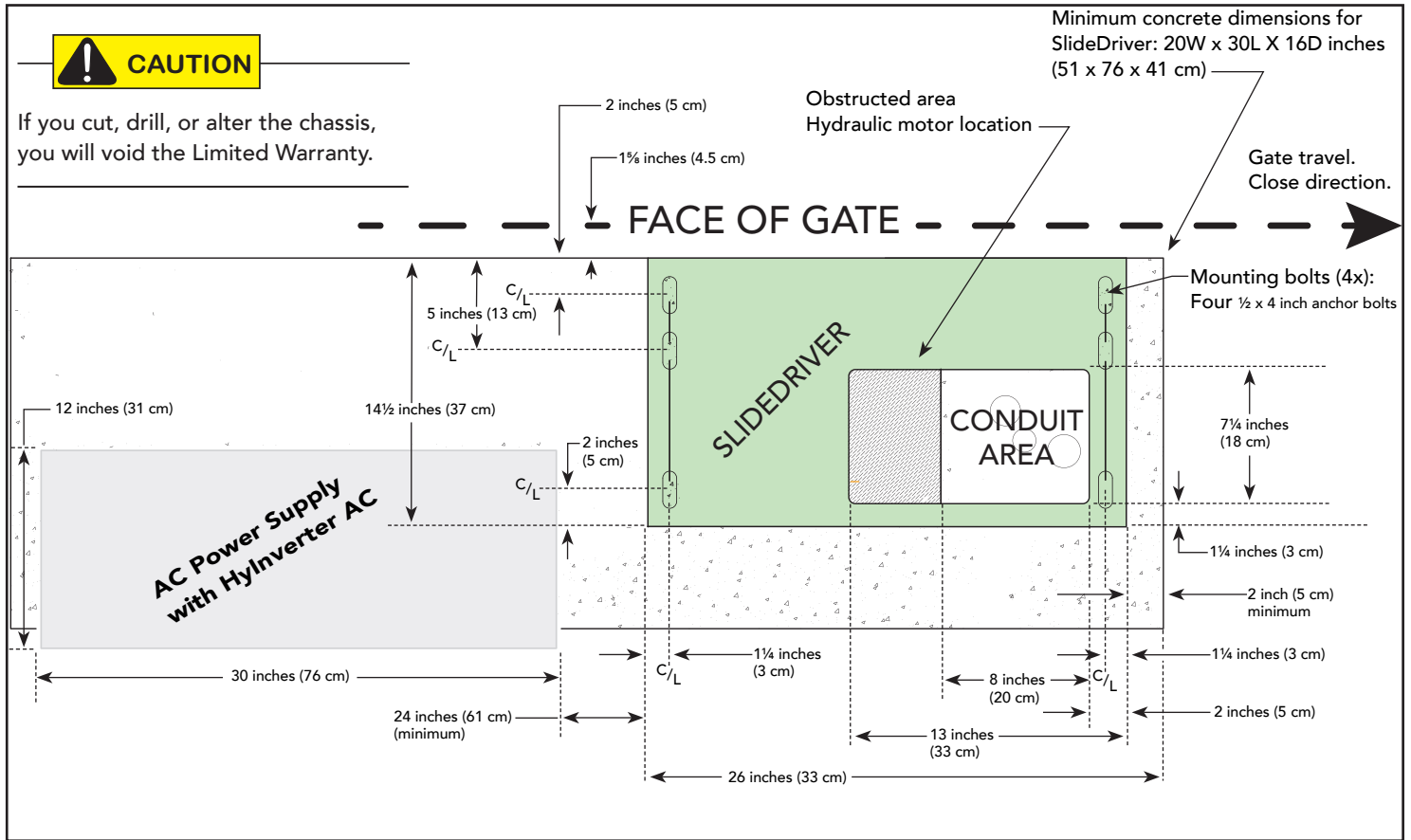

NOTE: The AC Power Supply with HyInverter AC may be wall-mounted, post-mounted or placed in a building. For maximum run from gate operator, refer to the wire size charts. Dimension for concrete pad, dependent on site design.

SlideDriver: Right Handing Configuration

The following illustrates the SlideDriver and AC Power Supply with HyInverter AC in a right handing configuration.

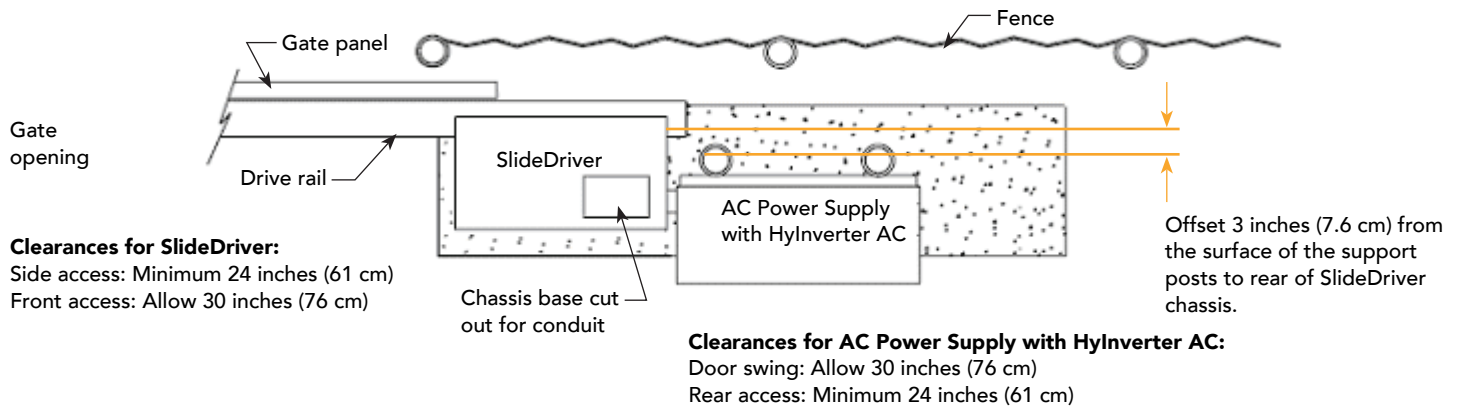

WARNING

The AC Power Supply with HyInverter AC cabinet is very heavy and requires separate lifting equipment to facilitate wall or post mounting. Failure to comply may result in serious injury to personnel, damage to the equipment, or both and is not covered by the Limited Warranty.

SlideDriver: Left Handing Configuration

The following illustrates the SlideDriver and AC Power Supply with HyInverter AC in a left handing configuration.

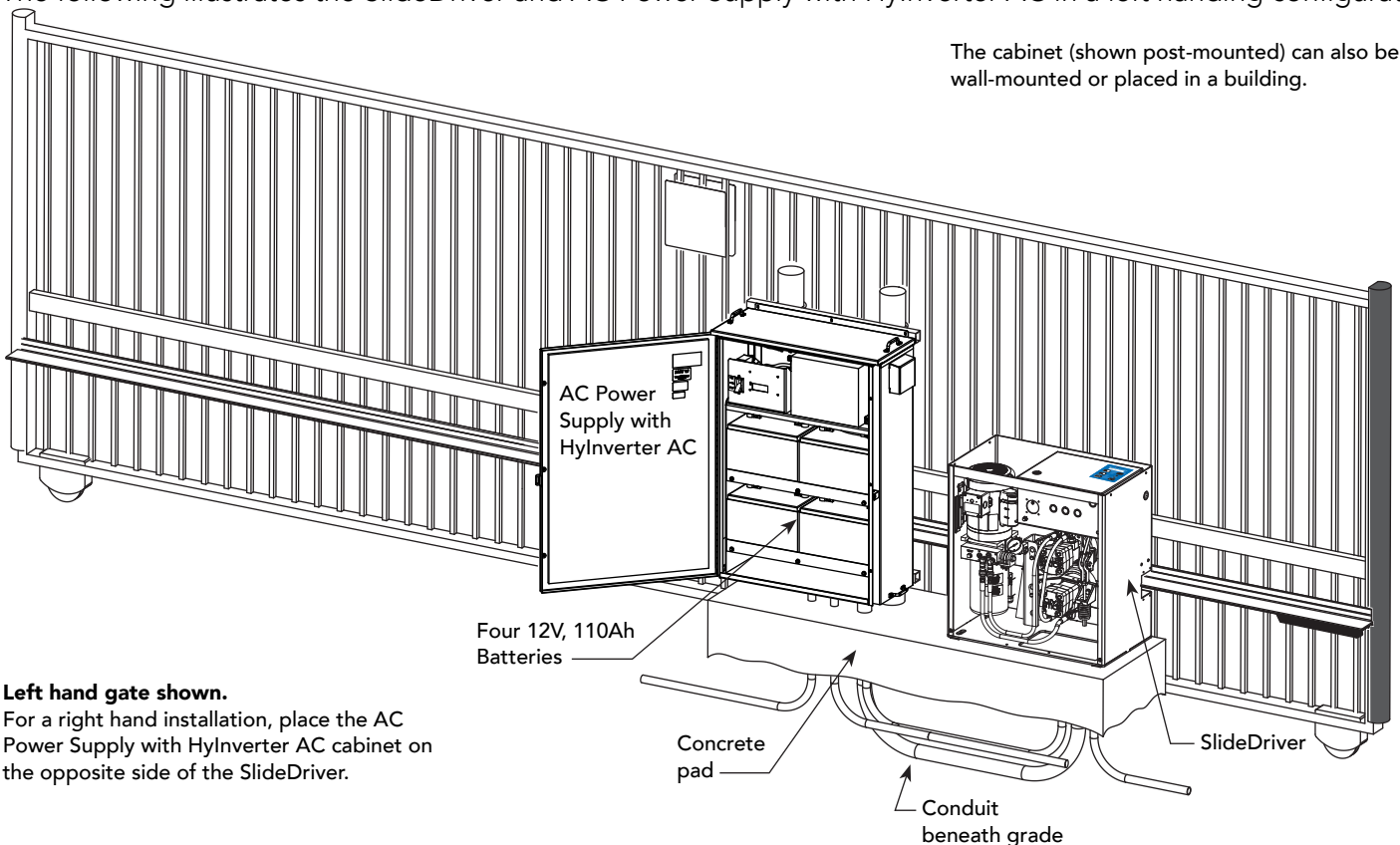

Left hand gate shown.
 For a right hand installation, place the AC Power Supply with HyInverter AC cabinet on the opposite side of the SlideDriver.

WIRE RUN AND WIRE SIZES

The wire run and wire size for HySecurity gate operators with the AC Power Supply with HyInverter AC option is identical to the wire run and wire size used with your gate operator. The wire size charts are found in the *Programming and Operations Manual* shipped with your HySecurity gate operator. A copy of the manual can also be found on the HySecurity website: www.hysecurity.com.

The maximum wire run distance reflects the distance from the gate operator to the main power source. Though AC power runs through the AC Power Supply with HyInverter AC, the wire size and run is determined according to the full distance that the gate operator is from AC main power source.

BATTERY SAFETY AND LONGEVITY



Residual amounts of electricity reside in the batteries even when the AC power switches are turned off. If shorted, the batteries can deliver very high currents. Exposed connector pins must be handled with extreme care and caution; they can be easily shorted against any metal surface. If a short circuit persists beyond one second; connectors, cables, and tools can be damaged or destroyed. Fire and personal injury may result and potential for electrical shock exists. Remove all metal objects from your person before servicing the AC Power Supply with HyCharger AC.

- Control of the load is important since the gate operator may need to run on backup batteries. Gates that move easily and do not bind will drain less energy from the battery, preserving capacity for more cycles during a power failure.
- Be certain to observe polarity when connecting the batteries or adding accessories. Reversed polarity may result in a non-functional operator or damage to a component. Red (+) is positive and black (-) is negative. If shorted, the batteries will generate a very high current. The batteries are connected in series on each shelf. Each battery “shelf” is connected to the other in parallel. See “General Maintenance” on page 39.
- **Variations in temperature affect battery performance!** Batteries have a finite life and age more quickly when exposed to temperatures above 80°F (27°C). A fan automatically turns on when internal cabinet temperature exceeds 110°F (43°C), +/- 5°. To provide residual heat inside the enclosure, HySecurity mounts a heater beneath each battery shelf which turns on when temperatures dip below 32°F (0°C), +/- 5°. **It is highly recommended to install the AC Power Supply with HyInverter AC indoors if extremes in temperatures exist at the site location.** An example of amp hour (Ah) performance is shown in the chart below.

Example of Battery Performance:	
Temperature	Capacity
77°F (25°C)	100%
32°F (0°C)	80%
-22°F (-30°C)	50%

- As the batteries age, they will progressively lose their capacity to store energy. If the total amount of back up capacity is critical, plan to replace the batteries after two years of use, especially in hot climates. Properly discard used batteries. See “Hazardous Materials and Proper Disposal” on page 4.
- Batteries contain sulfuric acid. Acid in your eyes, on your skin, or on your clothing can cause injury and severe burns. If batteries are dropped or damaged dispose of them properly.
- HySecurity uses permanently sealed AGM batteries which last longer than wet cell batteries and require no maintenance over their life span. Batteries are protected from over discharge by HyInverter AC.

How to wire the unit to AC power and locate the earth and equipment ground is described in this section.

INSTALLING THE EARTH GROUND

An earth ground refers to the grounding connections and accompanying equipment ground which need to be installed to safeguard against potential electrical shock and damage to personnel and equipment.



The potential for lightning discharge exists with all gates, fences and gate operators. National Electric Code (NEC) requires a separate earth ground in addition to the required equipment ground.

HySecurity recommends grounding the operator with a separate earth ground rod (or a similar device) to shield the operator against electromagnetic interference and other electrical signals that may cause erratic operation with, or damage to, the Smart Touch Controller and other electrical parts.

For earth grounding requirements in the U.S.A., refer to the National Fire Protection Association (NFPA) 780 - Standard for the Installation of Lightning Protection Systems. Highlights of the standard include:

- The ground rod must be UL listed copper-clad steel, solid copper, hot-dipped galvanized steel, or stainless steel. Minimum requirements: $\frac{5}{8}$ inch (16 mm) diameter and 10 feet (3 m) in length.
- The ground rod is driven into the earth (refer to local codes for proper depth requirements).
- The ground rod is electrically bonded to the chassis with a single length of unspliced 6AWG copper wire less than 3 feet (91 cm) long. Due to the large concrete foundation on crash products or indoor units, make the necessary adjustments to accommodate for earth ground requirements.
- Local jurisdictions may impose other requirements above the NEC, Article 250 and NFPA 780. Consult the local codes and regulations regarding requirements in your area.

NOTICE: Properly grounding the gate operator and AC Power Supply with HyInverter AC unit is critical to equipment performance and the life of its electrical components. Use sufficient wire size during installation. If you do not ground the equipment with a separate earth ground, you risk voiding the HySecurity Limited Warranty.

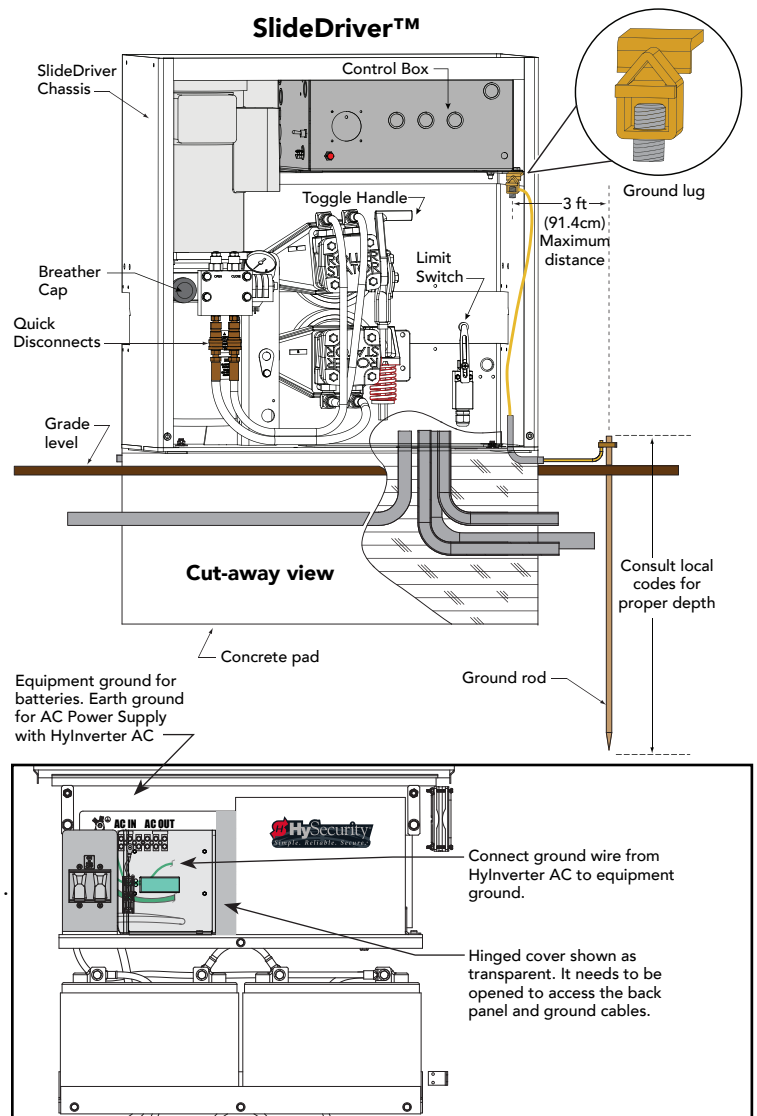

WIRING AC POWER

The AC Power Supply with HyInverter AC has a terminal block on its panel labeled L1 and L2 and T1 and T2.

Size the primary wires, appropriately. Consider the voltage, horsepower, and length of the wire run from the main power panel.

Verify you have the proper input voltage and make sure the motor and transformer are wired correctly. Wiring diagram is provided on the next page.



Turn OFF AC power at the source (circuit breaker panel) before connecting wires in the AC Power Supply with HyInverter AC or HySecurity gate operator. Follow facility Lock Out/Tag Out procedures. Make sure all power disconnect switches are in the OFF position. Follow all electrical code standards and regulations. Never connect AC OUT back to the main circuit breaker or any other power source.

1. Pull wires, from the main breaker box, through conduit and connect Line 1, Line 2 and ground to L1, L2, and ground. Refer to the illustration.
2. Connect and feed the appropriate wires (including the ground wire) from the T1 and T2 terminals through conduit to the HySecurity gate operator.
3. Attach the ground wires to the chassis. See below.

NOTE: HySecurity gate operators have separate *Installation Instructions* that explain how to connect to AC power. For more information, refer to your gate operator's manual.

In-rush Current: The current needed to start the electric motor spinning in the proper direction (CCW). It may take as much as 6 to 9 times the run current to start one of the heavy duty operators.

NOTE: Use a 20A slow blow (thermal) circuit breaker or fuse for all AC motors.

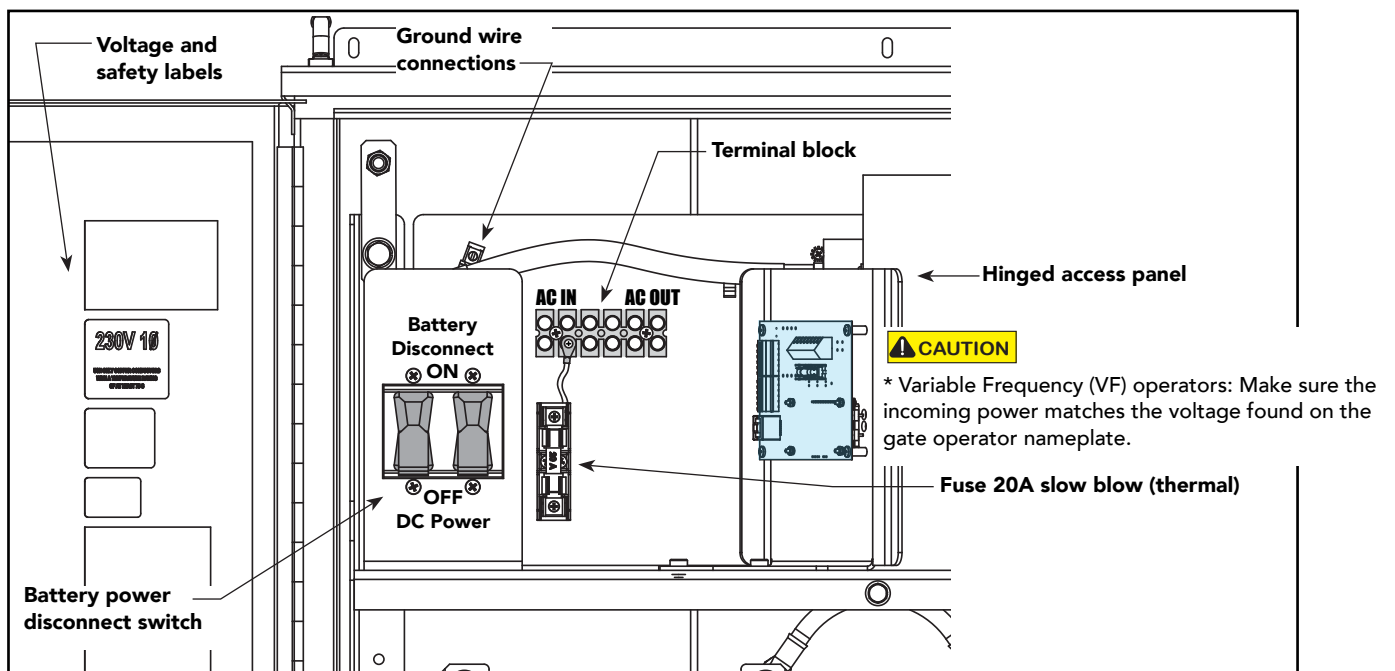

WIRING DIAGRAM: 208/230V

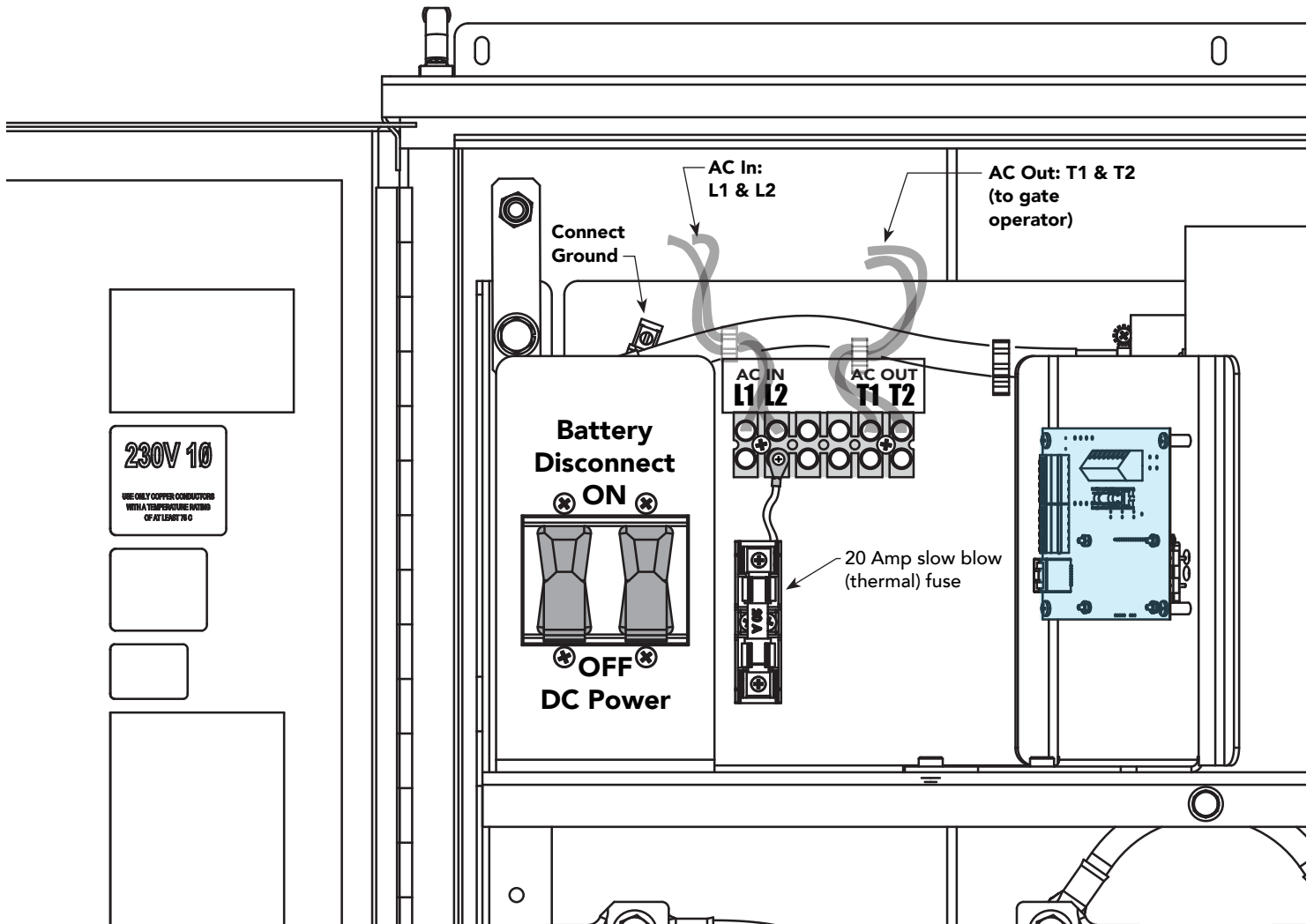

208/230V: ModBus Connection to the Smart Touch Controller

Drive Adapter Board

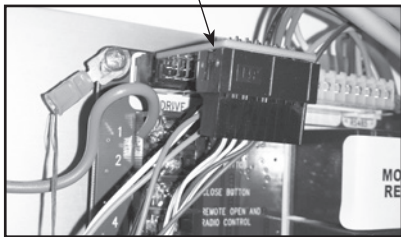

HylInverter AC ModBus Connections on the STC inside the gate operator.

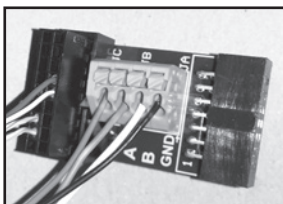

HylInverter AC ModBus RS-485 wiring to STC in gate operator.
(Requires up-to-date software)
18-20 AWG twisted and shielded wire, 2 pair.
Ground shield wire to gate operator only.

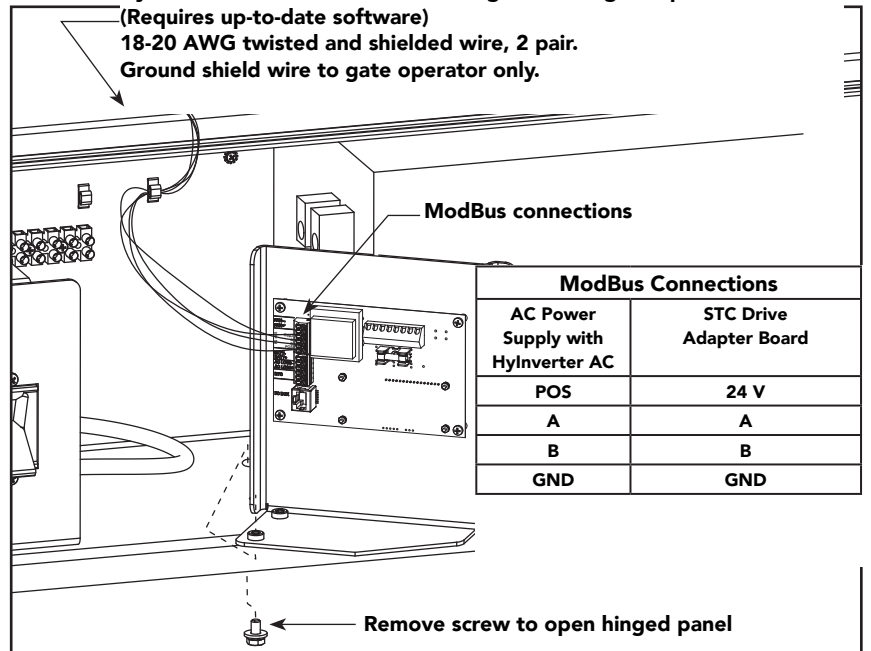

208/230V: ModBus / RS-485 Connections

NOTE: Drawings are not to scale.

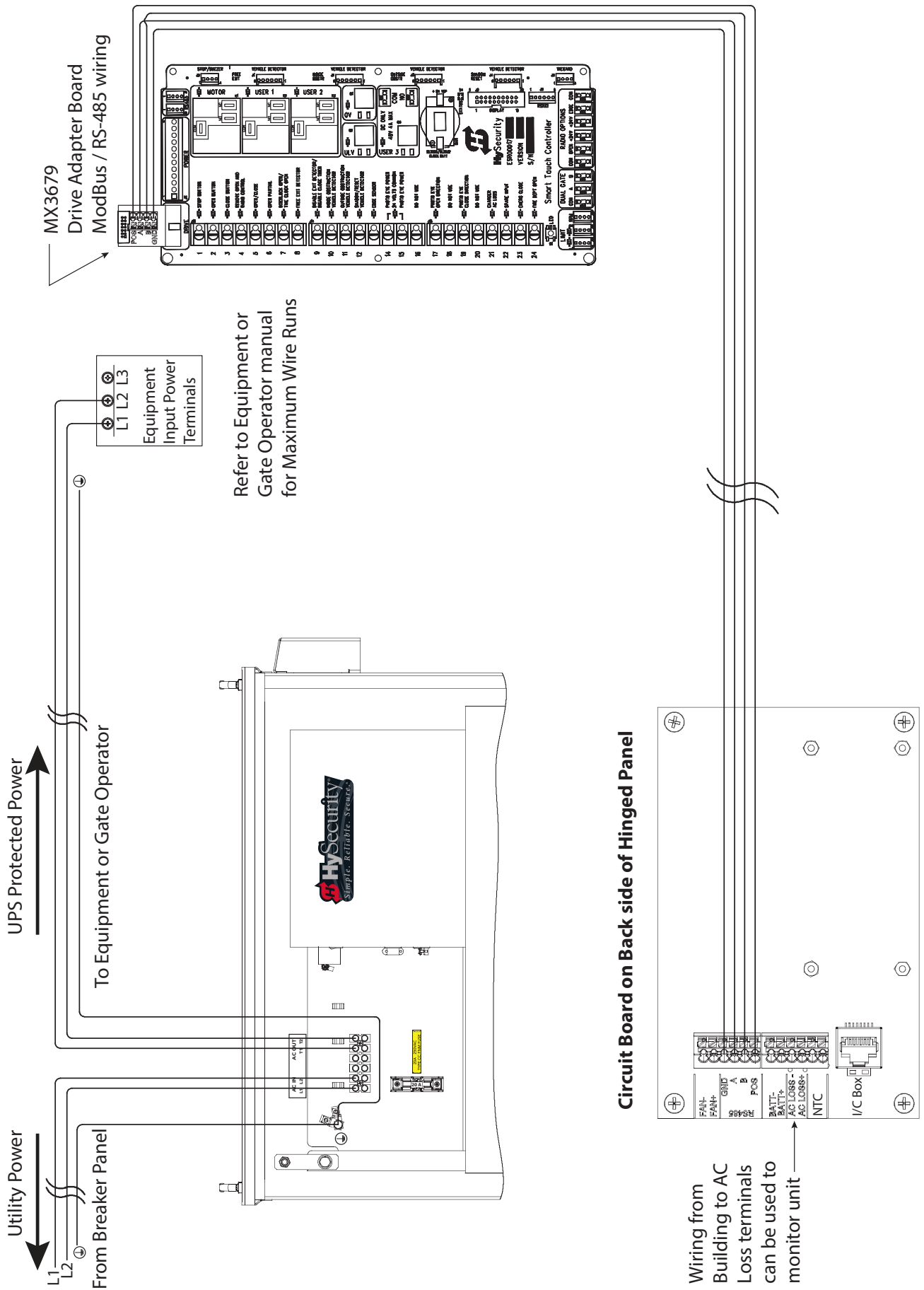

Wiring Diagram: HyInverter AC (MX3895 Revision A)

ESTABLISHING THE RS-485 CONNECTION

NOTE: The low voltage conduit required for the ModBus RTU via RS-485 wires is part of Site Prep and Planning. The installer is responsible for supplying the 18-20 AWG shielded twisted pair (STP) wires which have a maximum distance run of 2000 ft (609 m), significantly farther than the gate operator wire runs (Wire Run tables found in the gate operator's manual). How the ModBus wiring is routed inside the AC Power Supply with HyInverter AC is determined according to where the conduit emerges inside the cabinet. Ground shield wire attaches to gate operator only.

1. To open the hinged panel and access the ModBus connections, use a 7/16 inch socket (socket or crescent wrench) and remove the screw that secures the hinged panel.
2. Plug the 4 wires (18-20 AWG shielded twisted pair) into the electronics board per the labeling on the HyInverter AC Controller.

NOTE: If the shielded twisted pair wiring is not already blown through the conduit, you will need to do so.

3. At the gate operator, use a small flat head screwdriver to depress the push button connectors and attach the wires to the Drive Adapter Board per the following chart:

ModBus Connections	
AC Power Supply with HyInverter AC	STC Drive Adapter Board
POS	24 V
A	A
B	B
GND	GND

4. Plug the Drive Adapter Board MX3679 into the Smart Touch Controller. See photos. The connection is keyed. **DO NOT** force the connection as damage may occur to the pins and void the Warranty.

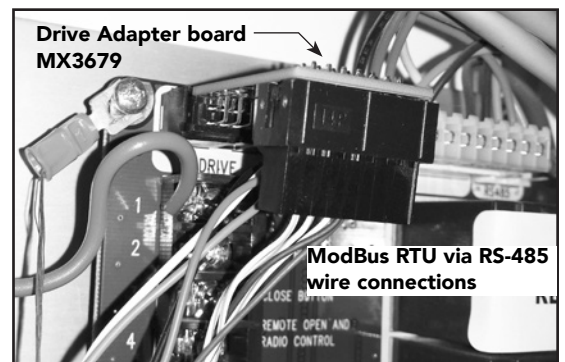
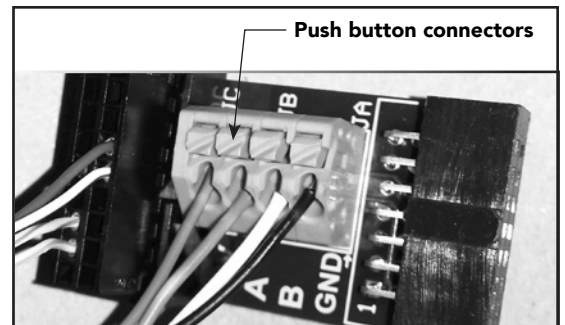
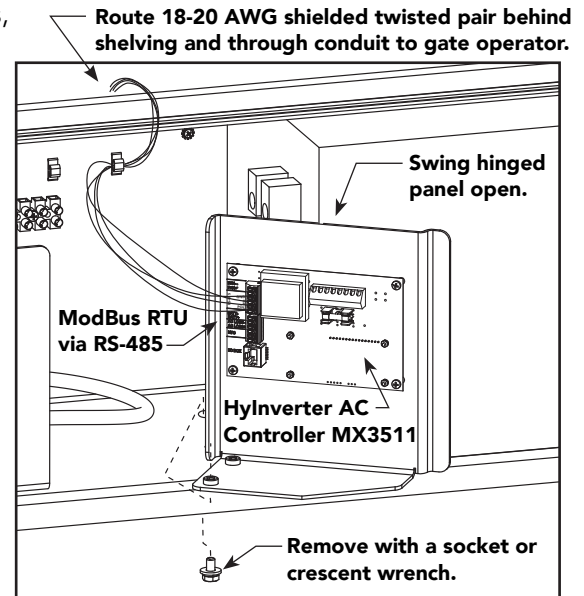

POWER AT SITE: CONSIDERATIONS

HySecurity gate operators and the AC Power Supply with HyInverter AC unit are intended for permanent installation. Make sure you prepare the site with the following considerations:

- All electrical wiring is properly routed via conduits.
- Make sure the wire size of the branch circuit supplying power to the equipment is large enough to avoid excess voltage drop. Refer to wiring charts found in your gate operator manual.
- The available power source matches the electrical requirements specified on the equipment's voltage nameplate.



Each gate operator is built to run on a specific line power voltage and phase. Failure to ensure the source voltage, phase and frequency match, as specified for the equipment, may result in severe damage to the equipment. Significant voltage drop can occur if wire size is too small.

-
- Make sure to provide a 20-amp circuit protected with a 20-amp Inverse Time Breaker.
 - A readily accessible disconnect switch must be provided in the field for the AC output exiting the AC Power Supply with HyInverter AC.
 - Maximum operating temperature for AC Power Supply with HyInverter AC is 122° F (50° C). See specifications on the back inside cover page.
 - Verify that the operator is electrically grounded per NFPA 780 and NEC Article 250, and local codes.

Connecting AC Power Supply with HyInverter AC

Connect AC power to the AC Power Supply with HyInverter AC per the wiring diagram shown on the previous page. Note the voltage, 208/230VAC, for your operator connection.

Connecting Gate Operator AC Power

Connect AC power to the gate operator per the information found in the gate operator's *Installation Instructions*.



Wiring of gate operators must conform to NFPA and NEC standards and comply with all local codes. When the installation is compliant and complete, turn on AC power at the source and at the control box.

AC Power Loss Considerations

- The gate operator software stores all User and Installer Menu settings in non-volatile memory (EEPROM). Configurations are saved if a power loss occurs and reinstated once power is restored. For more information, see "AC Power Loss Function: User Menu" on page 27.
- DO NOT attach the AC Power Supply with HyInverter AC unit to life sustaining equipment.
- DO NOT use the AC Power Supply with HyInverter AC unit to power equipment that sustains life.

TURNING THE POWER ON

- The battery power disconnect switch (breaker) is inside the AC Power Supply with HyInverter AC cabinet.
- The HyInverter AC “Mode Switch” is located on the back of the inverter inside the cabinet. It is in the OFF (neutral) position when shipped from the factory.
- The gate operator’s ON/OFF power disconnect switch is located either in or near the operator’s control box.
 1. When AC power is connected correctly, turn the Mode Switch to Auto/Remote (=) position by pressing the toggle switch downward.
 2. Turn ON the battery power disconnect switch (breaker).
 3. Replace the protective shield onto the AC Power Supply cabinet.
 4. Turn ON the equipment, such as the gate operator, being supplied power through the AC Power Supply with HyInverter AC.

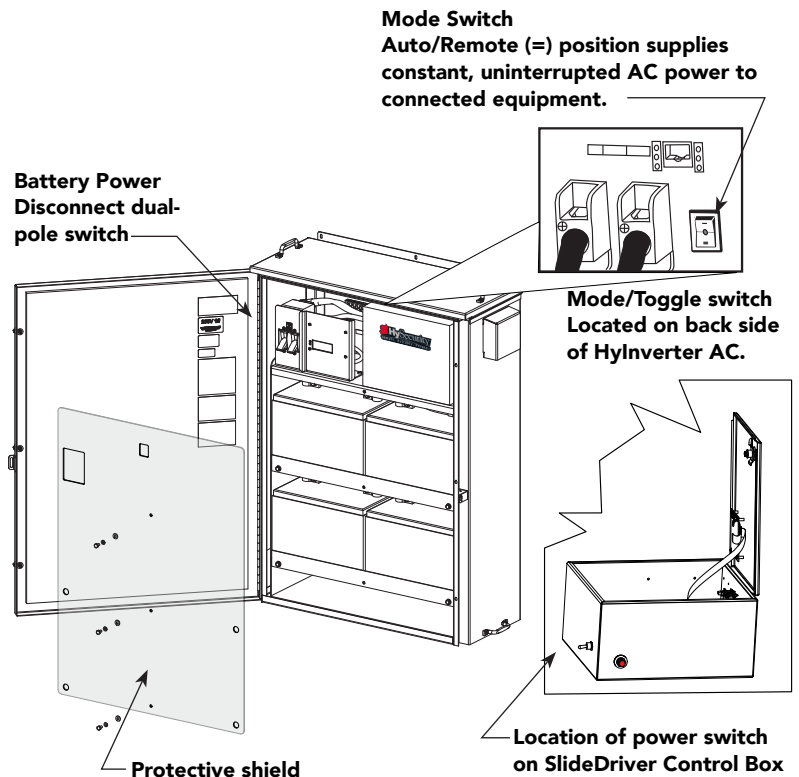

Green LED flashes indicating processor is receiving power.

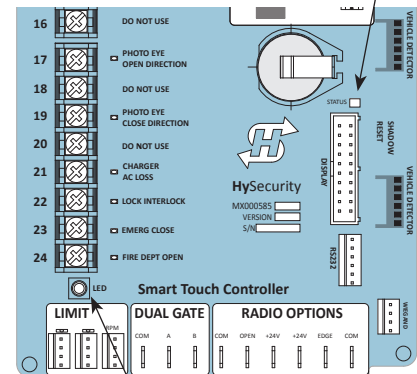

When power is turned ON, a green status light on the Smart Touch Controller inside the gate operator’s control box blinks. The status light appears below the disc battery and indicates that the processor is receiving power. Lights next to the active inputs are lit.

In a power conserving manor, when battery power is being supplied, you need to press the tact button to illuminate active inputs.

TEST THE GATE OPERATOR

Complete the installation by testing the operation of the gate.

NOTE: If the AC Power Supply with HyInverter AC is connected to a HySecurity gate operator, it must be turned ON and in Run mode. A Run mode display appears on the STC. If a Run mode status does not appear on the display, press Reset. If an error, alert, or fault appears on the display, refer to the “Troubleshooting” section to learn how to clear the display and return to Run mode.

1. Press Open or Close to cycle the gate.
2. Check the displays on the STC and the AC Power Supply with HyInverter AC for any Alerts, Faults, or Errors.
3. Test the operator.
 - ♦ Cycle the gate a more few times by pressing the Close and Open buttons.

NOTE: If installed for emergency fast operation, test the EMERGENCY CLOSE using the constant hold device. Observe the travel speed of the gate when you press and hold the Emergency Close button. It will close a second or two faster than normal operation and ignore any photo eye, vehicle loop, or other safety device inputs.

Performance of Gate Operators on Single Phase 50/60Hz

- The incoming voltage must match the operator nameplate, 208/230VAC single phase operation with no changes or reconnections.
- Any AC powered peripherals such as locks, card readers and other devices need to be checked for compatibility.
- The electric motors, in all variable frequency drive operators compatible with AC Power Supply with HyInverter AC, are 3Ø, 60Hz motors and are connected for the voltage (208V/230V) on the operator nameplate.

How is this done?

- The VFD controller in the compatible equipment is rated to operate on input frequencies ranging from 48Hz through 62Hz on 1Ø power, but only on 208V/230V.
- The control transformer in the operator has multiple voltage taps and is rated for 50/60Hz operation. Only connect incoming power to the 208/230 VAC wiring. See "Control Panel Components: HySecurity Gate Operator" on page 32.
- The VFD controller first rectifies and filters the incoming power to DC, which has no frequency or phase. It then creates 3Ø variable voltage/variable frequency AC for the motor from the DC.
- Depending on the model, the VFD controller ramps the motor voltage and frequency from 0V@0Hz at start, to either 208/230VAC at various frequencies for full speed. This allows use of 60Hz motors regardless of the incoming frequency.
- Since the input voltage/frequency is converted to DC to begin with, there is absolutely no relationship between the input frequency/phase and frequency/phase of the power supplied to the motor. The input can be 1Ø, 48Hz to 62Hz and the controller/motor combination wouldn't care. It will create the ramped 3Ø voltage and frequency for which it is programmed

In-Field Connections



HySecurity gate operators using AC Power Supply with HyInverter AC CANNOT be connected to 460VAC or 575VAC, 3Ø power. If any attempts are made to do so, serious injury, electrical shock, or death may result. Any electrical damage occurring to the operator will not be covered by the Limited Warranty.



HySecurity gate operators using AC Power Supply with HyInverter AC and a VFD are NOT field configurable.

NOTICE: A 20A circuit breaker for the branch power to the AC Power Supply with HyInverter AC must be provided in the field.

NOTICE: A readily accessible disconnect switch must be provided in the field for the AC output from the AC Power Supply with HyInverter AC.

Display & Menu Options

Highly sophisticated software, on your gate operator, provides three different modes of operation: *run*, *menu* (*program*), and *fault*. How to navigate using the Smart Touch Controller (STC) keypad, interpret status display codes and program the operator is found in your gate operator's product manual. A few highlights, to get you started, are provided in this section along with information about the AC Power Supply with HyInverter AC display and control panel.



Keep your operator current with the most up-to-date software version. Use of AC Power Supply with HyInverter AC requires a software version of H4.36 and S.T.A.R.T. version 2.98 or higher.

INITIAL SETUP

Once you have completed the installation, attached the wired accessories and turned the power ON, you're ready to program the operator. Two different approaches exist:

- Connect a laptop computer to the serial (RS-232) port, check for the most current software version and then set the operator menu configurations via the START software.

NOTE: Use a laptop computer at your place of business to conveniently download the free START software and most current software version from www.hysecurity.com before heading out into the field. This makes it easy to adjust settings using a laptop.



- Manually navigate through the User and Installer Menus using the STC keypad. The instructions for performing this second option are provided in this section.

After installing a new operator, an initial sequence of set up prompts appears when you first turn ON the Control Box power switch. You need to answer the prompts before the gate operator will run. The operator is in "MENU" mode.

UC = Usage Class. Set the usage class to 1, 2, 3, or 4 depending on the site.

Four different vehicular usage classes are defined by UL 325. Information about the classes can be found online through DASMA Technical Data Sheets www.dasma.com or UL 325 www.ul.com

S1, S2, and S3 = Contact and non-contact external entrapment protection sensor inputs that may require monitoring per installation site and UL 325 Standard of Safety requirements.

For more information, refer to UL 325 - 2016 Monitored Entrapment Wiring Diagrams online.

INITIAL SETUP USING S.T.A.R.T.

With the S.T.A.R.T. application (available online after registering at HySecurity) uploaded to your PC laptop, you can choose to set site menu configurations from the comfort of your office. Then, simply bring your PC laptop to the gate operator site, connect to the gate operator using an RS-232 to serial download cable and USB adapter, and download the configured menu settings file from your laptop to the specified gate operator.0

Multiple operators can be configured in this way. No switches need to be set.

All the components are securely placed in a Control Box inside the chassis.



a company of TheNiceGroup

To access the S.T.A.R.T. free software application, register online at HySecurity (or use your existing login ID).

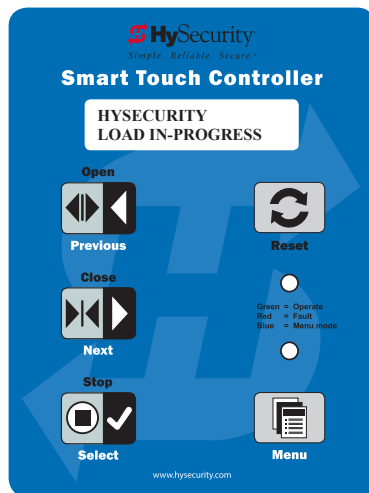
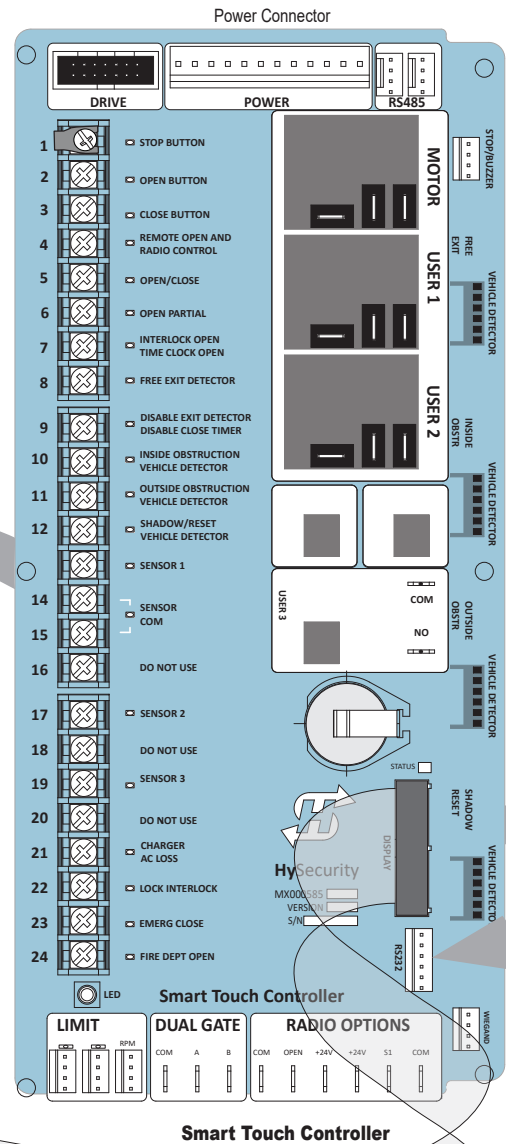
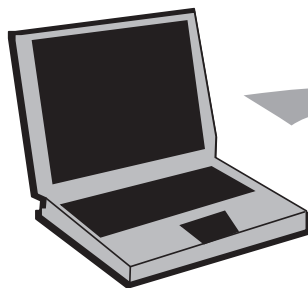

Smart Touch Controller: Downloading S.T.A.R.T. software

GATE OPERATOR DISPLAY AND KEYPAD

The STC display and keypad provide access to the operator's sophisticated software and functionality.

Three different operational modes exist:

- Run Mode - gate is operational, awaiting commands.
- Menu (Program) Mode - motor disengages and operational commands are ignored. Data entry, menu navigation, and menu selection can be accomplished via the keypad or through a START software connection using the RS-232 port.
- Fault Mode - alerts, faults, or errors appear on the display. Some errors or faults can be reset with the Reset button while more serious faults require additional troubleshooting. Faults indicate a need for diagnosis and resolution. Refer to "Troubleshooting" on page 35.
- The keypad lets you navigate, change, or clear the information in the display menus. The singular use of these keys is dependent on the operator mode.
- The buttons with text above and below have two functions. Use these buttons to enter operating commands or navigate through the User and Installer Menus.

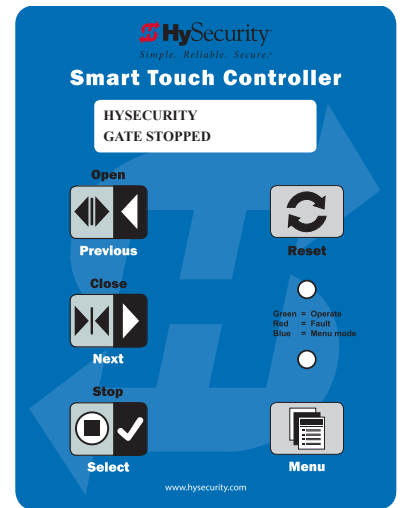

Gate Status Display in Run Mode

MENU MODE AND THE STC KEYPAD

In Menu (Program) Mode, the motor disengages and operator commands are ignored. Data entry, menu navigation, and menu selection can be accomplished using the buttons on the Smart Touch Controller keypad.

NOTE: Menu Mode automatically returns to Run Mode if no activity (i.e. key presses) occurs for two minutes.

Two blinking characters indicate that the display will accept changes.

32-character display provides information about the menu items.

Next or Previous
Navigational buttons.
Pressing Next or Previous scrolls through the options.

Pressing **Select** causes the left most two characters to blink, (CT in the example), which indicates the display is ready to accept changes to a menu setting.

The **Reset** button is disabled while in Menu Mode.

The **Menu** button accesses Menu mode. When the menu item is selected and blinking, the Menu button has no function. However, pressing Menu when the 2 characters are static (not blinking), returns the operator to Run Mode.

Use the navigational buttons to view selections. Press **Select** a second time to accept what appears on the display. Entry mode is exited, the two characters stop blinking, and Next or Previous must be pressed to move onto a different display. Pressing Menu exits to Run mode.

MENU MODE NAVIGATION

Navigating within the program menus is easy once you learn how the keypad buttons function. Refer to the following chart.

Smart Touch Controller: Menu Mode Navigation Buttons

To change that data appearing in the display	To navigate through the Selections	To choose what appears on the display	To navigate between menu items
Press Select . Two left characters blink.	Press Next or Previous . Continue pressing Next to view all selections.	Press Select . Blinking characters become static.	Press Next or Previous . Advance - press Next Previous - press Previous

RUN MODE AND THE STC KEYPAD

The Run Mode displays appear static when the operator is ready and waiting for a run command. When the display is flashing GATE OPENING or GATE CLOSING, a command has been received and the barrier gate is in motion. The command may come from a variety of sources: a card reader, push-button remote, or recognition of a vehicle passing over a loop detector. In all cases, the operator “runs” the motor when it receives an operational command.

Three displays indicate the position or status of the barrier gate. The keypad entry used to access the User or Installer menus, begins at one of these Run Mode displays.

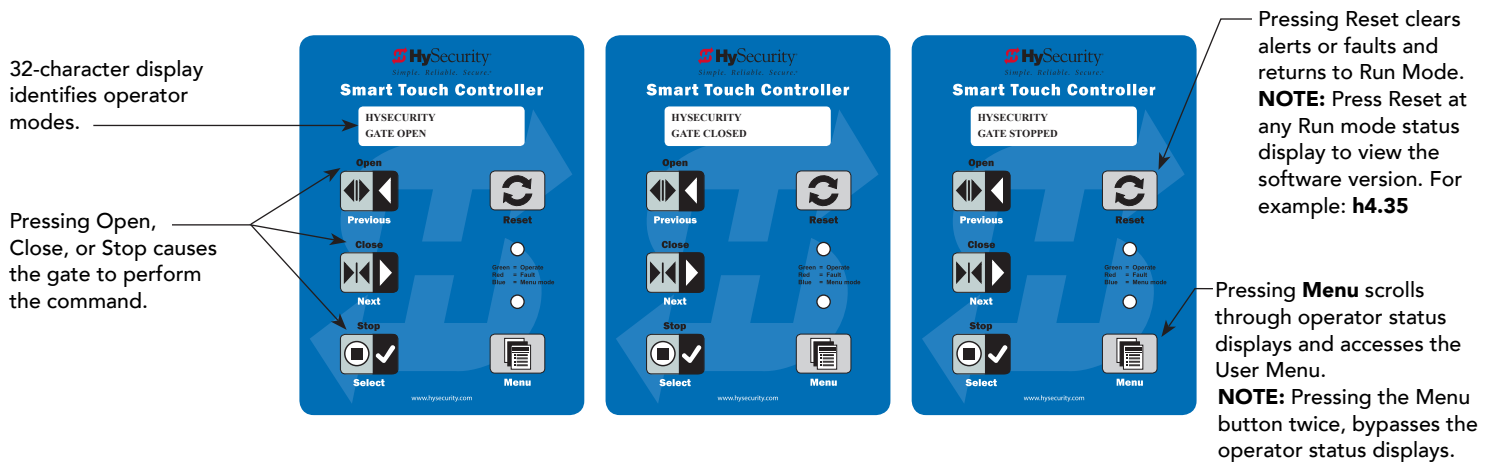

Run Mode Displays

NOTE: To access the User or Installer menus, the motor cannot be engaged and the gate cannot be moving.

Viewing Gate Operator Scrolling Status

Press the Menu button once and the operator status displays scroll past in two second intervals. Pertinent information appears to provide a quick overview of the operator's status or configurations.

The type of information that may scroll across the display includes: interlocked or sequenced gate (if applicable), operator type (OT), Usage Class (UC), buss voltage, and life cycle counter.

Check Time and Date

An easy way to determine if your operator is set for the correct date and time zone can be accomplished by taking the following steps:

1. While in Run mode (gate status appears in the display), press and hold the STOP button.
The date appears DD/MM, and then the time HH:MM.
2. If you need to change the time zone, refer to the Set Clock "CL" item in the User Menu.

Stop the STC Status Display Scroll

To stop the operator status display scroll and focus on one item, press Select. Press Select a second time, to resume the scrolling display. Status scrolling also occurs when you press the Menu button once.

Change the Contrast on 7-Segment STC Display

While the gate operator status displays are scrolling, you can change the contrast (on the 7-segment display) by pressing the up or down arrow keys. The display's contrast changes accordingly. The operator status displays continue to scroll and stop at the User Menu entry item.

NOTE: Since sunlight does not affect readability on the OLED display, changing the display contrast is not available on gate operators shipped with the 16 character, 2 line display.

Display Power Saving Mode

To conserve energy, the display dims after a period of time if no keypress, run command or fault occurs. When an event (keypress, run command, or error/alert/fault notification) occurs, the display returns to full brightness.

Check the Software Version

Press Reset. The display indicates the software version loaded on the gate operator. To upload software, you will need a PC laptop. For more information, see "Smart Touch Analyze and Retrieve Tool (S.T.A.R.T.)" on page XXX.

VIEWING AC POWER SUPPLY WITH HYINVERTER AC DISPLAY

The display, on the AC Power Supply with HyInverter AC, provides system status messages only. All programming is completed through a connection to STC (display and keypad or S.T.A.R.T. input) on the gate operator. The buttons stop and start the scrolling display status messages. See "Control Panel Overview" on page 31, for more information.

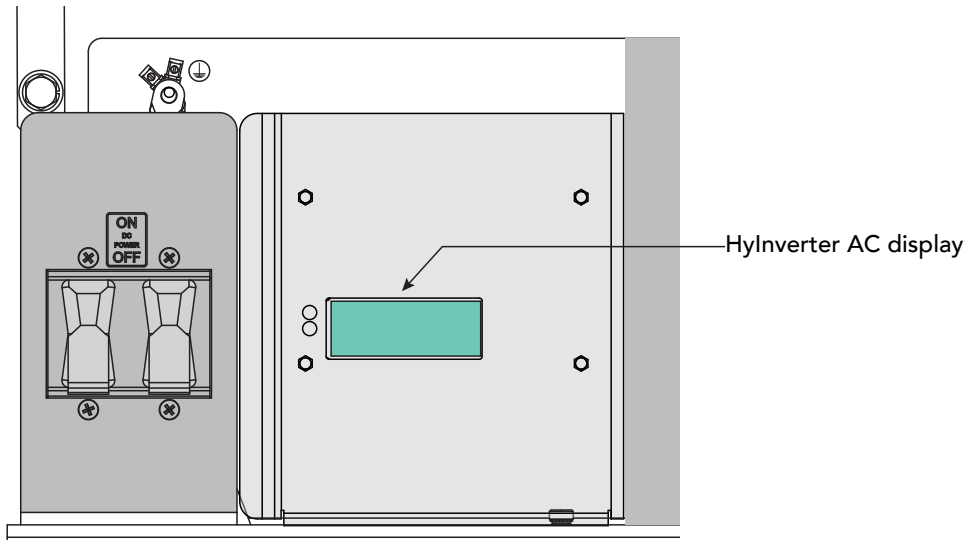

AC Power Supply with HyInverter AC Display

NOTE: All programming is completed through interaction with the Smart Touch Controller (its display and keypad). Use of a PC laptop with S.T.A.R.T. can also be used to connect to the STC and program the gate operator.

The following chart describes the scrolling status displays in the AC Power Supply with HyInverter AC.

AC Power Supply with HyInverter AC Status Display	Description
Input Line Volts xxx.x VAC	Displays the input voltage (VAC) from the main power source to the HyInverter AC. Indicates that the AC Power Supply with HyInverter AC is receiving AC power and converting it to maintain and sustain optimal battery life.
Enclosure Temp	Provides the internal temperature of the enclosure in degrees Fahrenheit and Celsius. An exhaust fan or heater automatically turns on to keep the interior at optimal temperatures for protecting the batteries.
Battery Voltage	Indicates the voltage of the 24VDC battery bank (four AGM batteries 110Ah, 12VDC)
Battery Level	Displays the level of charge in the battery bank. The HyInverter AC always maintains an optimal charge. An error message appears on the HySecurity gate operator's Smart Touch Controller display if the voltage level of the batteries drops below 22VDC. Refer to Troubleshooting in your gate operator's <i>Programming and Operations Manual</i> for more information.

NOTE: Comparable displays appear in the STC Installer Menu with the "ID" diagnostics display.

AC POWER LOSS FUNCTION: USER MENU

The AP setting configures how the gate functions when AC power fails. The AC Power Supply with HylInverter AC does not have a keypad so User Menu items can only be modified using the Smart Touch Controller keypad found in the gate operator.

The User Menu item specific to AC Power Supply with HylInverter AC power loss is described below. For the full list of User Menu items, refer to your gate operator's *Programming & Operations Manual*.

Access:

Pressing the Menu button, at one of the STC static Run Mode displays, causes the operator status displays to scroll past, stop and display the first user menu item.

NOTE: To access the User Menu, the operator must be in Run Mode. To bypass the operator status displays, press the Menu button a second time.

The Close Timer (or HC, Hold to Close) display is the first in a cyclical series of User Menu displays.

The LED on the keypad appears blue to indicate Menu Mode.

Use the navigational buttons, Select, Next, and Previous to change or view the menu functions. Refer to the chart, *Smart Touch Controller: Menu Mode Navigation Buttons* on page 24.

Table 1 and Table 2 describe the User Menu item specific to AC Power Loss. (Factory default settings are shown in bold.)

User Menu: Table 1

User Menu	7 Segment Display	Setting Options	Menu Tasks & Explanations	STC Wire Connections
AP 0 AC LOSS UPS FAIL OPEN	AP_0 AP_1 AP_2 AP_3	0 = UPS FAIL OPEN 1 = UPS FAIL CLOSE 2 = AUTO OPEN 3 = NO CLOSE TIMER	This menu item only appears if the operator is DC powered. The setting configures how the gate functions when AC power fails.	COM Terminal #21 UPS Terminal strip 24 VDC to control box power disconnect switch - and + ModBus connection. See "Establishing the RS-485 Connection" on page 17.

Refer to the next table for a description of the different AC Loss (AP) settings.

AP Menu, AC Loss: Table 2

User Menu Setting	Menu Tasks & Explanations	STC Wire Connections
AP 0 AC LOSS UPS FAIL OPEN AP_0	If the battery voltage drops below 20V, the gate operator opens and locks the gate until battery voltage recovers to 23.5V. The gate can be closed: <ul style="list-style-type: none"> Manually By pressing the Close button By an Emergency Close input The gate may be re-opened by any open command until the battery voltage drops to 17V, at which time the gate is absolutely locked open, unless moved manually.	ModBus connection See "Establishing the RS-485 Connection" on page 17.
AP 1 AC LOSS UPS FAIL CLOSE AP_1	If the battery voltage drops below 20V, the gate operator closes and locks the gate until battery voltage recovers to 23.5V. The gate can only be opened by pressing the Stop button and then (within 1 second) pressing the Open button. NOTE: The Fire Dept. open input overrides the previous statement. The gate may be re-closed by pressing the Close button or using the Emergency Close input. When the battery voltage drops to 17V, the gate completes its final cycle and remains in the fully open or fully closed position.	ModBus connection
AP 2 AC LOSS AUTO OPEN AP_2	Five seconds after AC power loss, the gate operator automatically locks open until AC power is restored. The gate can be closed: <ul style="list-style-type: none"> Manually By pressing the Close button By an Emergency Close input The gate may be re-opened by any open command until the battery voltage drops to 17V, at which time the gate is absolutely locked open, unless moved manually.	ModBus connection
AP 3 AC LOSS NO CLOSE TIMER AP_3	After AC power loss, the gate operator remains quiescence until it receives an open command, and then automatically locks open until AC power is restored. The gate can be closed: <ul style="list-style-type: none"> Manually By pressing the Close button By an Emergency Close input If the battery voltage drops to 17V, the gate remains locked open, unless moved manually.	ModBus connection

INSTALLER MENU

The Installer Menu options provide more advanced configurations for the gate operators. Access to the Installer Menu is through the User Menu. The navigational buttons are the same in both menu modes.

Access:

While a static gate status is being displayed, press the Menu button twice. (Bypasses the operator status displays.)

When the Close Timer display appears (Hold to Close, if the Close Timer display is hidden):

1. **Access the Installer Menu** by simultaneously pressing and holding the Reset and Open buttons.
2. Release both buttons and the display changes, indicating you have arrived at the first item in the Installer Menu.

NOTE: Installer Menu options can also be configured through the use of a laptop computer and S.T.A.R.T. software. See *Smart Touch Analyze and Retrieve Tool* information found on the HySecurity website: www.hysecurity.com

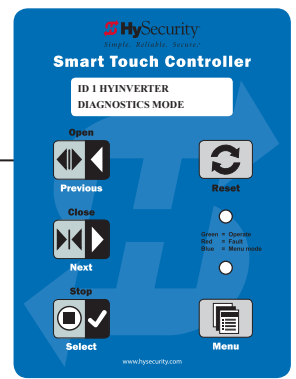
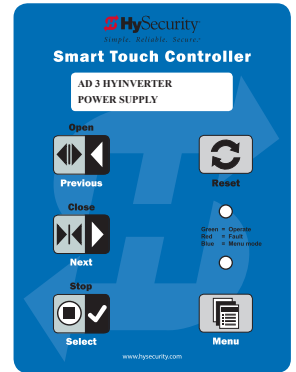

"Installer Menu: Table 3" on page 30 describes the Installer Menu items in or affected with the AC Power Supply with HyInverter AC. Make sure your gate operator has the most up-to-date software so you can access the AD menu item 3. The "ID" diagnostics menu item only appears when AD is set to 3.



Keep your operator up-to-date with the latest software version. Use of the AC Power Supply with HyInverter AC, and other accessories requires the current version of software. Upload it to your PC laptop from www.hysecurity.com and use S.T.A.R.T. to download it to the Smart Touch Controller in your gate operator.

INSTALLER MENU: TABLE 3

Installer Menu	Setting Options	Menu Tasks & Explanations	STC Wire Connections
AD 0 AC/DC GATE	0 = gate disabled 1 = AC (alternating current) 2 = DC battery-power 3 = HyInverter-Power Supply	Select the type of power that the operator uses and is appropriately wired. NOTE: This menu item only appears when the OT (operator type) is set. (OT 1- 4, 7-9)	N/A
TL 2 (45 SECS) OPEN TIME ALERT	0 = 0s delay 1 = 15s 2 = 45 second delay 3 = 75s 4 = 105s 5 = 135s	Let's you to specify when the relay activates. The relay turns ON when the software detects that the gate operator has been off its close limit for the specified period of time. With updated software versions, TL appears in the Installer Menu even without the User Relay option 8 being utilized. It's appearance, in the Installer Menu, had been suppressed in earlier versions of software.	User Relay 8
LT 3 (75 SECS) LOITERING ALERT	0 = 0s delay 1 = 15s 2 = 45s 3 = 75 second delay 4 = 105s 5 = 135s	Let's you to specify when the relay activates. The relay turns ON when the software detects that the gate operator has been off its close limit for the specified period of time. With updated software versions, LT appears in the Installer Menu even without the User Relay option 13 being utilized. It's appearance, in the Installer Menu, had been suppressed in earlier versions of software.	User Relay 13
ID 0 HYINVERTER DIAGNOSTICS	0 = no diagnostics displayed 1 = view diagnostics displays HYINVERTER INPUT - LINE xxx.x VAC HYINVERTER TEMP - xxx.xF / xxx.x C HYINVERTER VOLTS - BATTERY xx.x VDC HYINVERTER - BATTERY xxx.x %	Controls which system diagnostics appear on the display. With a setting of 1, you access the AC Power Supply with HyInverter AC diagnostic mode. These same diagnostics appear on the AC Power Supply with HyInverter AC display in a constant scrolling format. Use the Next or Previous buttons, on the gate operator's keypad, to view the same diagnostics on the STC display.	AC Power Supply with HyInverter AC to STC (Modbus RTU communication protocol via RS-485)

Control Panel Overview

This section provides an overview of the electrical controls found in your AC Power Supply with HyInverter AC and HySecurity gate operators. The illustrations highlight the various components and describe their function.

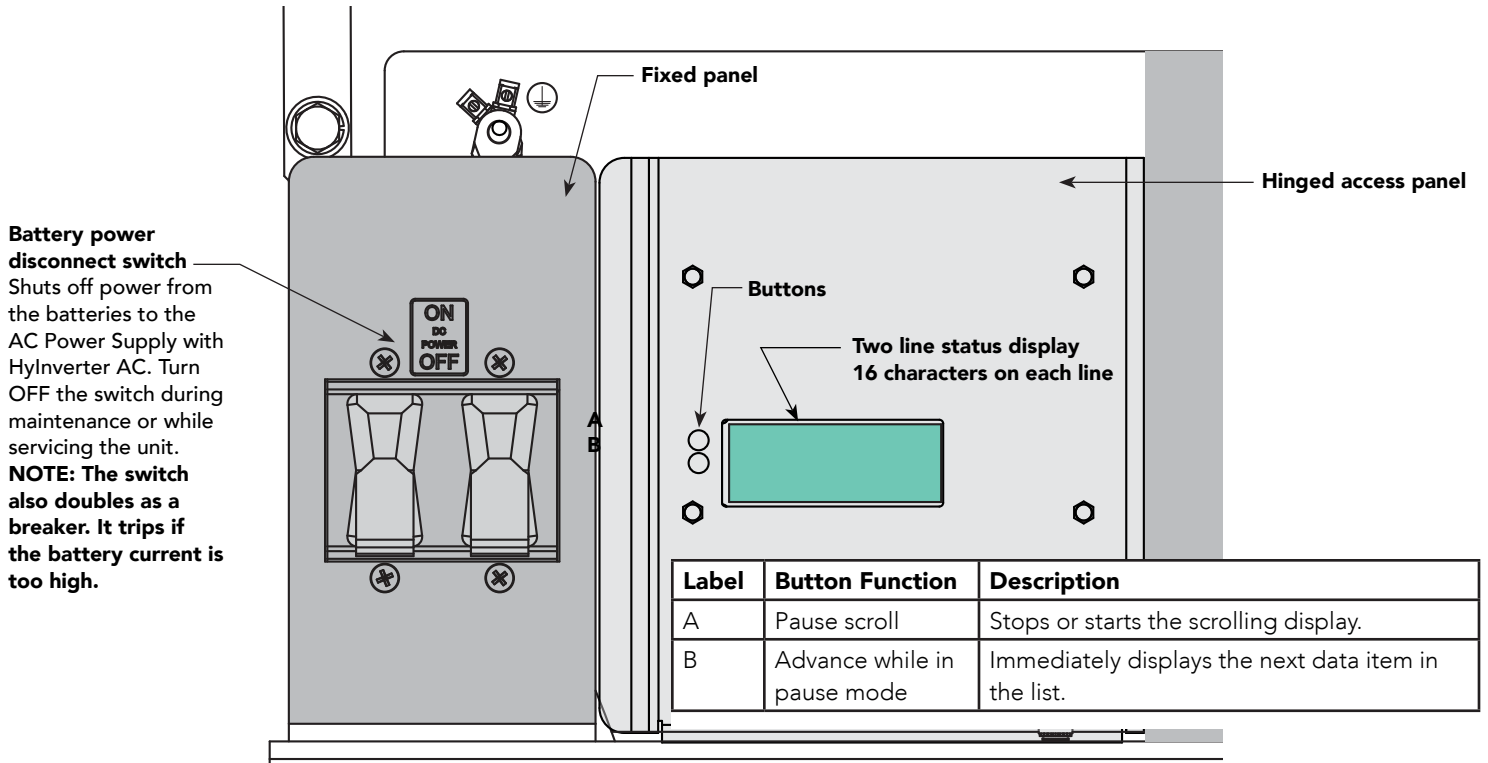

AC Power Supply with HyInverter AC Control Panel

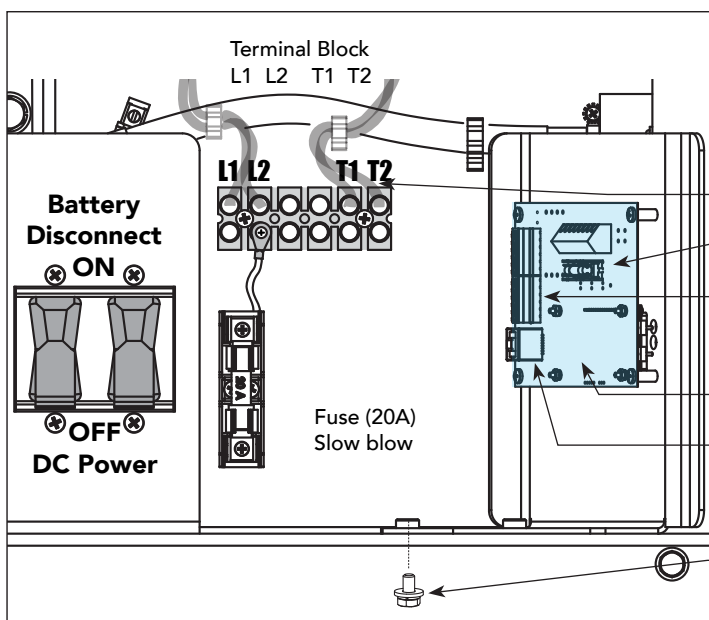

Open Hinged Panel

1. Use a 7/16-inch socket wrench to remove screw.
2. Swing panel open.

NOTE: Replace screw to secure hinged panel after closing it.

AC Power Supply with HyInverter AC Hinged Panel and Electronics

CONTROL PANEL COMPONENTS: HySECURITY GATE OPERATOR

A Control Panel from a StrongArm CRASH HySecurity gate operator is shown below as an example of possible components in your gate operator. Note that only 3Ø gate operators have the Variable Frequency Drive.

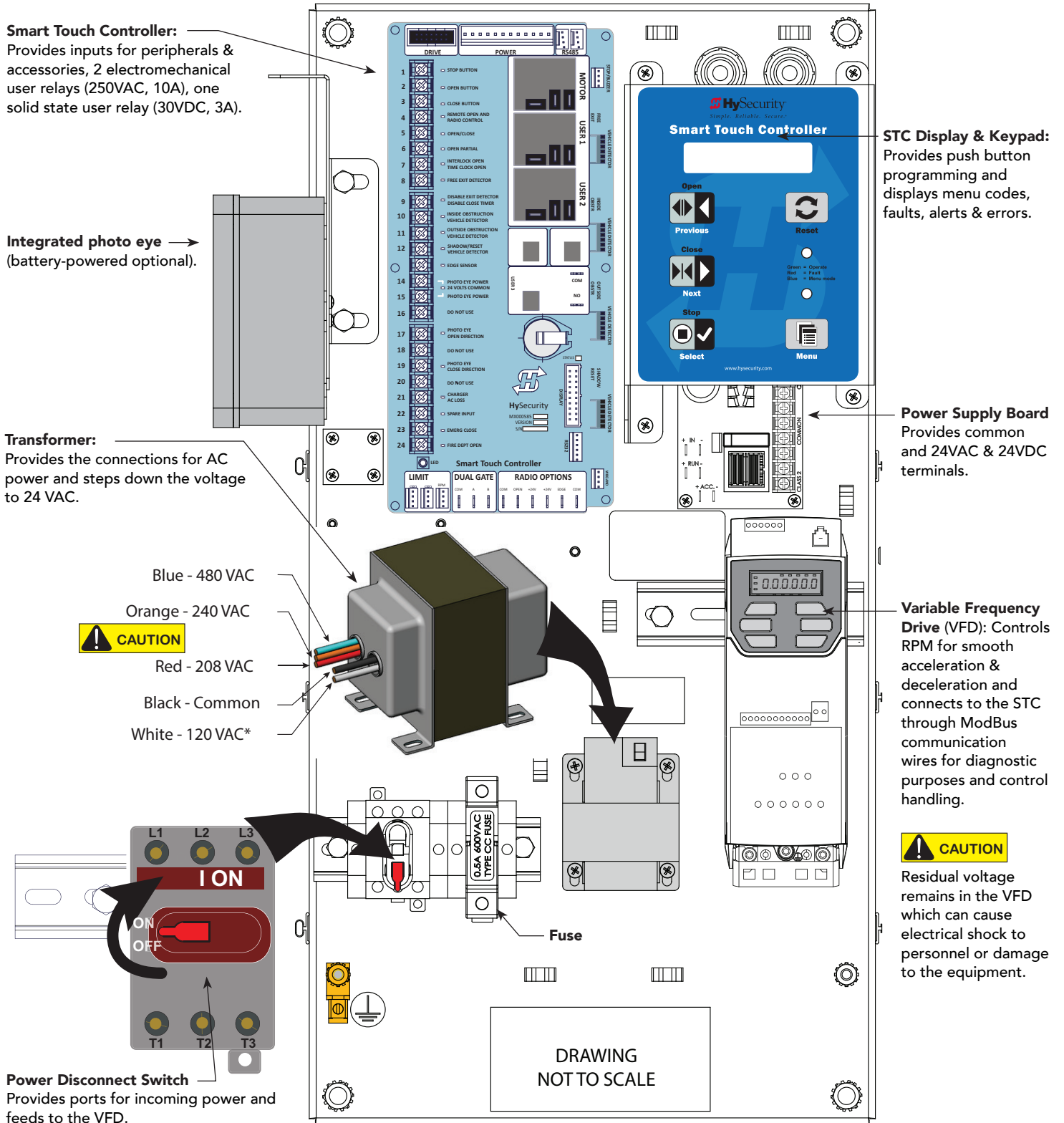

STC BOARD, POWER SUPPLY BOARD AND DISPLAY

The Smart Touch Controller provides connections for a multitude of peripherals and accessory devices. The Power Supply Board offers 8 common buss terminals, 4 terminals (24VAC) and 3 terminals (24VDC) with a 3A maximum draw. The touch-sensitive keypad and 16-character, 2-line display connects to the STC with a waterproof ribbon cable. For more information about STC Inputs and connections, see the product manuals that accompany your gate operator.

Smart Touch Controller:

Provides inputs for peripherals & accessories, 2 electromechanical user relays (250VAC, 10A), one solid state user relay (30VDC, 3A).

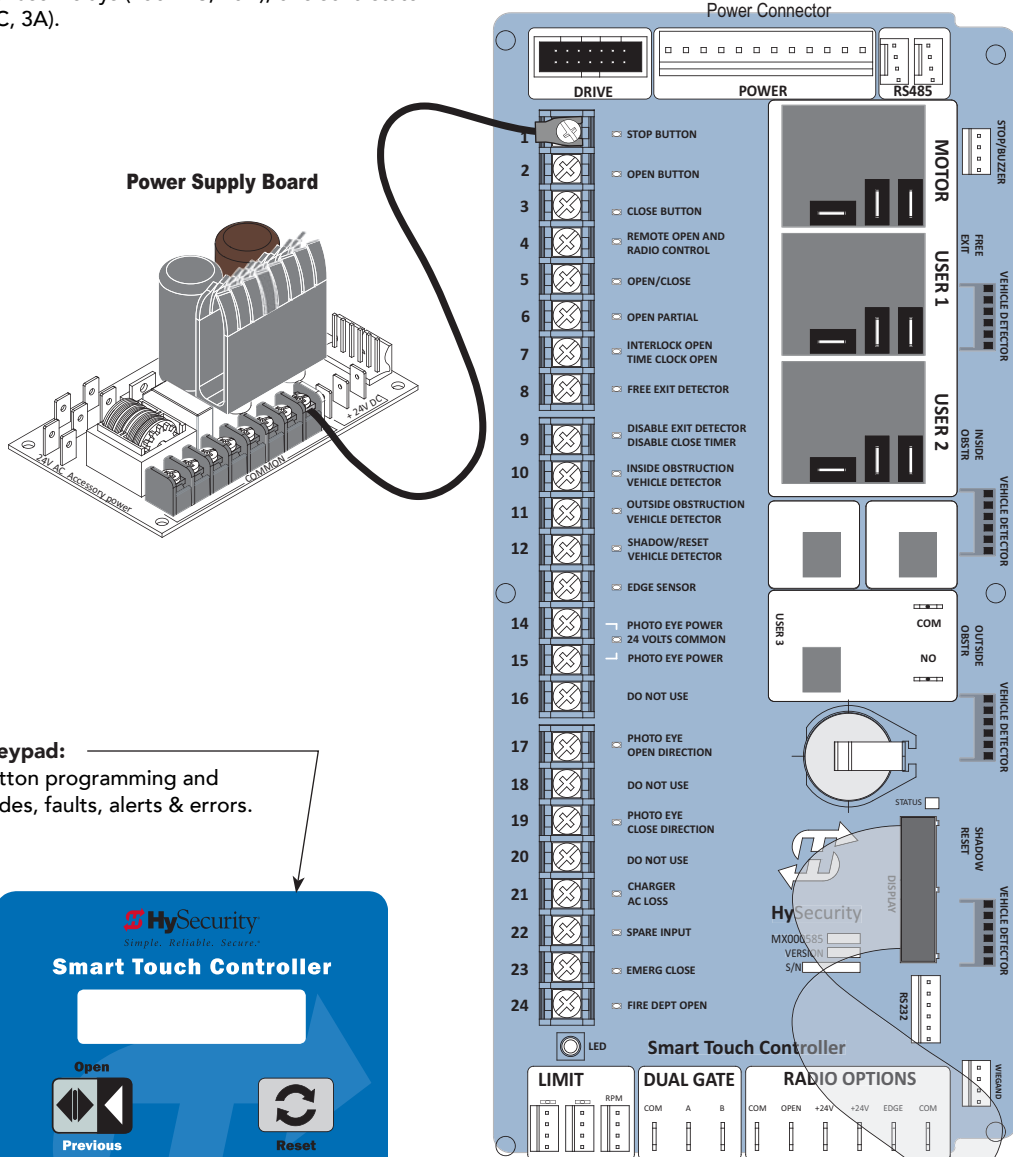

Power Supply Board

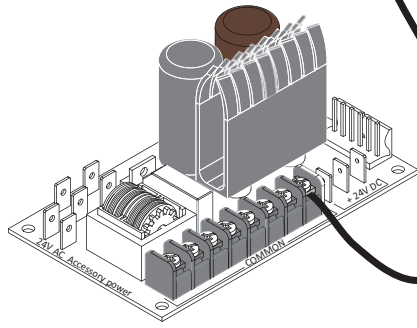

STC Display & Keypad:

Provides push button programming and displays menu codes, faults, alerts & errors.

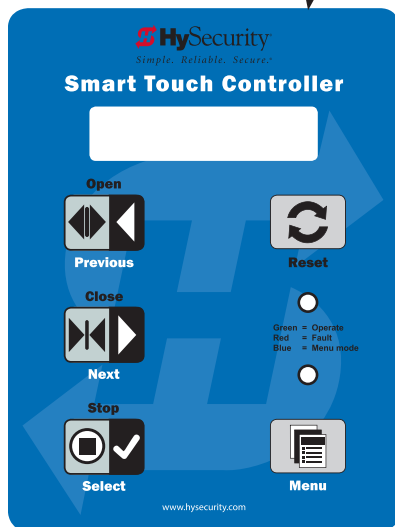

Ribbon cable

ModBus RTU

A communication protocol allows the Smart Touch Controller to constantly monitor the AC Power Supply with HyInverter AC and record events in the STC history log. The history log is easily accessible using the HySecurity S.T.A.R.T. program and a PC laptop computer.

With the ModBus RTU:

- Reduction in field calls is likely because the STC resets VFD faults or error codes upon receiving a new command.
- Quality issues with the site power are controlled better which results in less intermittent operator problems.
- Smoother operator acceleration and deceleration enhances gate travel.

All AC Power Supply with HyInverter AC units have the ModBus cable and RTU communication protocol installed.

AC LOSS RELAY

The AC Loss Relay is activated when the incoming VAC is below 200VAC or the incoming VAC is above 264VAC. The relay is a solid state device. It can drive up to 100mA at 12-48VDC. There are no settings for the relay. It is not used with the STC and is provided for "other appliances." The relay is open on power loss.

Troubleshooting

The Smart Touch Controller reports system malfunctions using three simultaneously occurring methods:

- Codes presented on its display (alert, fault or error)
- Activation of a buzzer which emits a series of chirps at defined intervals
- Stop gate travel

A short list of codes appears in this section and provides troubleshooting solutions for AC Power Supply with HyInverter AC powered gates. For a complete list of troubleshooting codes, refer to the Troubleshooting Codes table in your gate operator's *Programming and Operations* manual.

To help in diagnosing a controller board problem, the active status of each input on the Smart Touch Controller is indicated by its associated LED.

- On AC- powered gate operators: Active-input LEDs are always illuminated.
- On DC- powered gate operators (with AC input OFF): Press and hold the Tact button to illuminate the active-input LEDs.

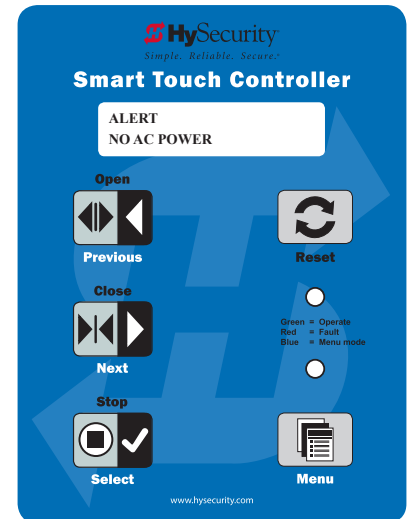

NOTE: A qualified technician may troubleshoot the operator with the aid of the information and procedures that follow. If it is necessary to call a distributor for assistance, be sure to have the model and serial numbers available. Other helpful information is the job name, approximate installation date, and service records of any recently-performed maintenance work.

The control panel and two line, 16-character display on the AC Power Supply with HyInverter AC provides a system status scroll:

- Incoming Input Line Voltage (VAC)
- AC Power Supply with HyInverter AC Enclosure Temperature (automatically regulated)
- Battery Voltage (VDC)
- Battery Level (percent remaining)

The AC Power Supply with HyInverter AC status can also appear on the gate operator's STC display.

A menu item, AC Power Supply with HyInverter AC Diagnostics (ID 0), is available in the Installer Menu. By selecting a setting of ID 1, the same diagnostics that scroll on the AC Power Supply with HyInverter AC display can be viewed. For more information, see "Installer Menu: Table 3" on page 30.

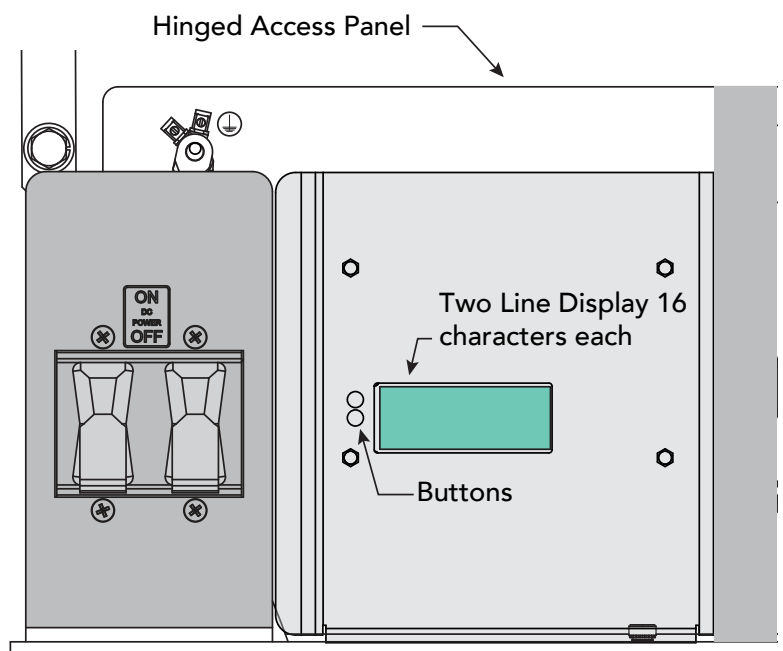

STC SYSTEM DIAGNOSTIC MESSAGES

Code	Priority	How to clear
ALERT	Low	Enter new command such as Open or Close.
FAULT	Medium	Press the Stop or Reset button
ERROR	High Serious issue that may require Technical Support.	Errors can only be cleared by pushing the Reset button or cycling power.

NOTE: The green LED near the coin-sized battery on the Smart Touch Controller is the “heartbeat” of the processor. This LED flashes continuously and at a constant rate when the system is operating normally. When a fault, error, or alert occurs, it turns red.

The Smart Touch Controller maintains self-diagnostics. Specific codes appear on the display and the Audio Alert buzzer emits distinctive chirping sounds. Any Alert, Fault, or Error is logged into memory and stamped with the date and time. These diagnostic messages can be retrieved for analysis purposes via optional S.T.A.R.T. software and a PC laptop.

NOTE: S.T.A.R.T. configuration and diagnostic software is available at no charge from www.hysecurity.com.

Troubleshooting Codes: Table 1

Type	Alert/Fault/Error Display	Buzzer Chirp Sequence	Possible Cause & Suggested Corrective Action
ALERT	NO AC POWER	Chirps once whenever the gate reaches the close limit	AC power is shut off at the source (breaker) or is not connected. <ul style="list-style-type: none"> • Have a licensed electrician check the wiring. • Connect AC power to the operator. • Reset circuit breaker at the electrical panel. • Reset the operator circuit breaker. • Turn AC power switch on.
ALERT	LOW 24VDC (BATTERY)	No chirps; LCD flashes for 1s every 5s	Only occurs in DC powered operators. Occurs when battery voltage has dropped to less than 22V. At this level, batteries are 80% depleted. Normal function until 21V. NOTE: Functionality of the controller board becomes impaired when less than 20% of the battery charge remains. <ol style="list-style-type: none"> 1. Check that AC power is available. Check all wiring connections. Clean or repair as required. 2. Check the following and replace, if necessary: <ul style="list-style-type: none"> • Battery condition • Charger failure. Check charger voltage • STC • Transformer
ALERT	HYSECURITY BAD POWER (POWER DOWN)	No chirps: LCD steady and controls disabled	Critically low DC power. System monitors 24V control voltage in lieu of line voltage. Low incoming line voltage will cause low control voltage. Verify control transformer is connected properly, (white – not used, red for 208V, orange for 230V and blue for 460 V). As motor starts, check line voltage with a meter that has min/max hold capability. If line voltage drops more than 10% below nominal (187 on 208 VAC, 207 on 230 VAC, or 416 on 460 VAC) voltage is dropping too much and must be corrected. Generally, this requires larger wire size. On 3-Phase operators, check each leg to ground to make sure it is balanced. If line voltage is not dropping below these limits, check 24V AC and DC power at power supply. Voltages less than 20V indicate an overloaded or failing transformer or power supply board. Remove loads until the fault is found.
ALERT	DEAD BATTERY DC BUSS < 21V	3 chirps upon any operating command entry	Appears when the battery power drops too low, disabling the operator to prevent damage to the batteries from excessive discharge. Verify the AC power is present at the AC Power Supply with HyInverter AC, the charger is on and charging. The charger should shut off when the batteries are fully charged. If the batteries will not “hold a charge” replace them. <ol style="list-style-type: none"> 1. No AC Power. 2. Wiring / Connector problem - check all connections. Clean or repair as required. 3. Check battery condition. 4. Smart Touch Controller charger failure - check charger voltage and replace Smart Touch Controller. 5. Transformer failure - replace Transformer.

Type	Alert/Fault/Error Display	Buzzer Chirp Sequence	Possible Cause & Suggested Corrective Action
ALERT	ALERT 17 BAD COIN BATTERY	3 chirps at initial power up	The small coin battery on the STC is loose or needs replacing. 1. Verify that the battery is properly seated. 2. Replace coin battery. 3. Restore power. 4. Press RESET button.
FAULT	FAULT 6 HYINVERTER OVRLD	2 chirps per second once per minute	Excess output load on the AC Power Supply with HyInverter AC causing power loss. Check gate hardware for binding (ice, poorly maintained gate, etc.) Check start/stop switch on 1 hp motor gate operators.
ERROR	ERROR 7 MENU CHECKSUM	3 chirps per second once per minute	Software issue exists that may require factory reset. Corrupt software or data. Contact HySecurity.
ERROR	ERROR 13 HYINVERTER COMM	3 chirps per second once per minute	Communication does not exist between the AC Power Supply with HyInverter AC and the Smart Touch Controller in the gate operator. 1. Check communication wires are connected and working properly. 2. Verify that your operator has the current software.
FAIL	FAIL PROGRAM DATA ERR	3 chirps per second once per minute	1. Try turning off the power to the operator and having the customer re-seat all of the various connectors and cables. 2. Upload the latest software release. If the fail does not go away, call Tech Support.

General Maintenance

Refer to your gate operator's product manuals for problems concerning gate movement and software or hydraulic issues.

BATTERY MAINTENANCE

Four 12V, 110Ah AGM batteries store the energy produced by the AC Power Supply with HyInverter AC during an AC power loss. Though the batteries should hold a charge for years, time and environment can take its toll. Optimum temperature for battery life is 70° F (21° C). Review "Battery Safety and Longevity" on page 12. If you are consistently receiving an alert on the gate operator's STC display that the batteries are low or dead, it's time to replace them.



Prevent Electrical Shock! Do NOT touch both poles of the battery at the same time otherwise serious injury and shock or burns will occur. Be sure to remove any metal (rings, jewelry, tools, etc.) and any conductive products from your person before servicing or working near the AC Power Supply with HyInverter AC.

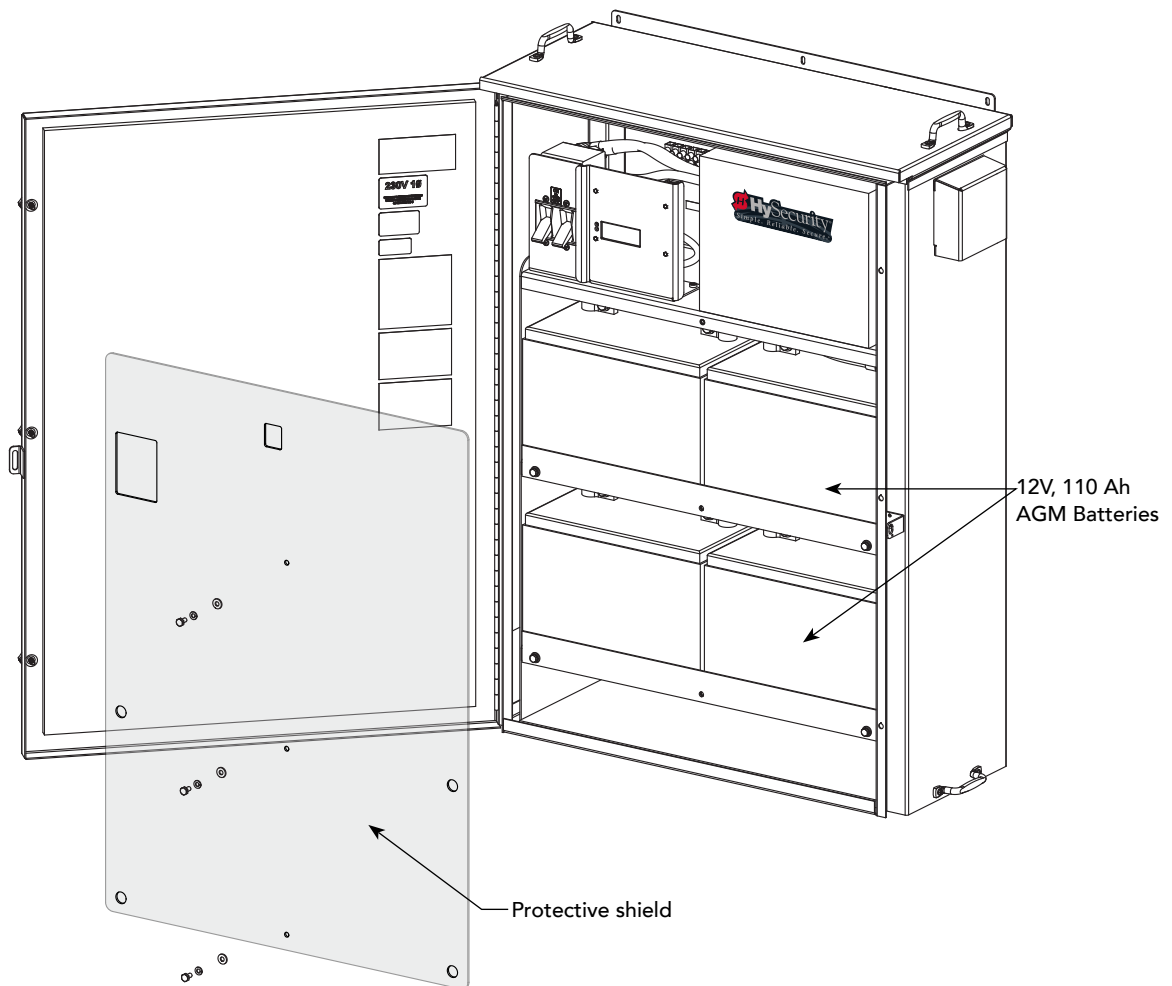

REPLACING THE BATTERIES

To access the batteries, you will need to remove the plastic guard, the lip of the shelf and disconnect the battery wires. For ease of wiring, the batteries are positioned with the front label facing the rear panel.

Review “Prevent Electrical Shock” on page 3 and “Hazardous Materials and Proper Disposal” on page 4, before proceeding with the steps below.



Turn OFF AC power at the source (circuit breaker panel) before replacing batteries in the AC Power Supply with HyInverter AC. Follow facility Lock Out/Tag Out procedures. Make sure all power switches are in the OFF position. Follow all electrical code standards and regulations.



Allow 5 minutes for the system to self-discharge. Remove all metal from your person (rings, necklaces, etc.)

To replace the batteries, take the following steps:

1. Turn OFF AC and DC power. Read DANGER and CAUTION messages above.
2. To access the shelves, remove the protective shield. See illustration on previous page.
3. Open the cabinet and turn OFF the battery disconnect switch.
4. Use a $\frac{7}{16}$ -inch box end or socket wrench to remove the bolts that hold the shelf lip in place. Work on one shelf at a time.

Refer to the “Battery Wiring Diagram” on page 41 for the following steps.

5. Use a $\frac{9}{16}$ -inch and crescent wrench to remove the center jumpers.
6. Remove the positive (red) wires from battery terminals.
7. Remove the negative (black) wires from the battery terminals.
8. Remove the two batteries from the shelf and perform steps 4 through 7 on the next shelf. Set those batteries aside, as well.
9. Replace the spent batteries with four new 12V, 110Ah AGM batteries. Use only AGM batteries as replacements. Make sure the front label faces the rear panel.
10. Reverse the step process to rewire the new AGM batteries. With the batteries on the shelf:
 - Reconnect the negative (black) wires.
 - Reconnect the positive (red) wires.
 - Connect the red main battery power disconnect switch (breaker) wire per the wiring diagram.
 - Reconnect the center jumper wires.
11. Replace the shelf lip when all the batteries are connected and positioned properly.
12. Turn ON power at the main circuit breaker.

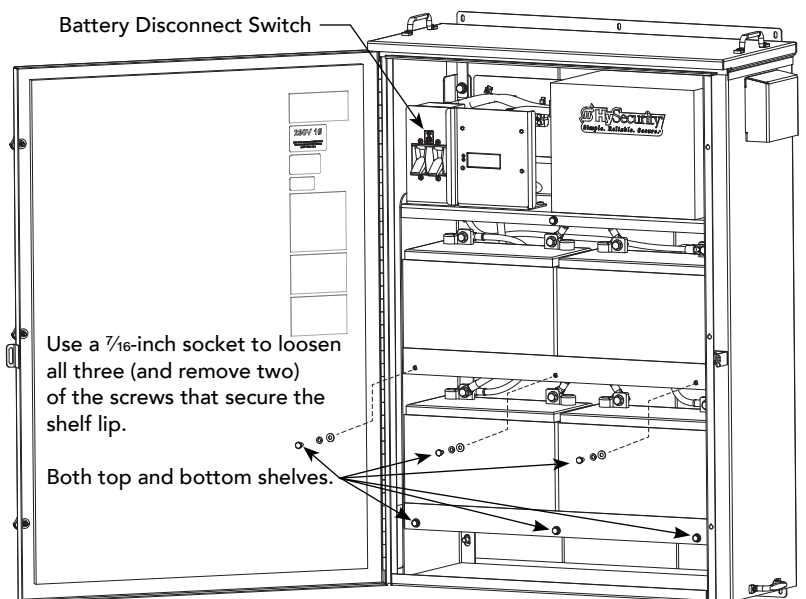

13. Turn ON the Battery Disconnect Switch and turn ON the gate operator's power switch.
14. Test the operator. See "Test the Gate Operator" on page 19.

Battery Wiring Diagram

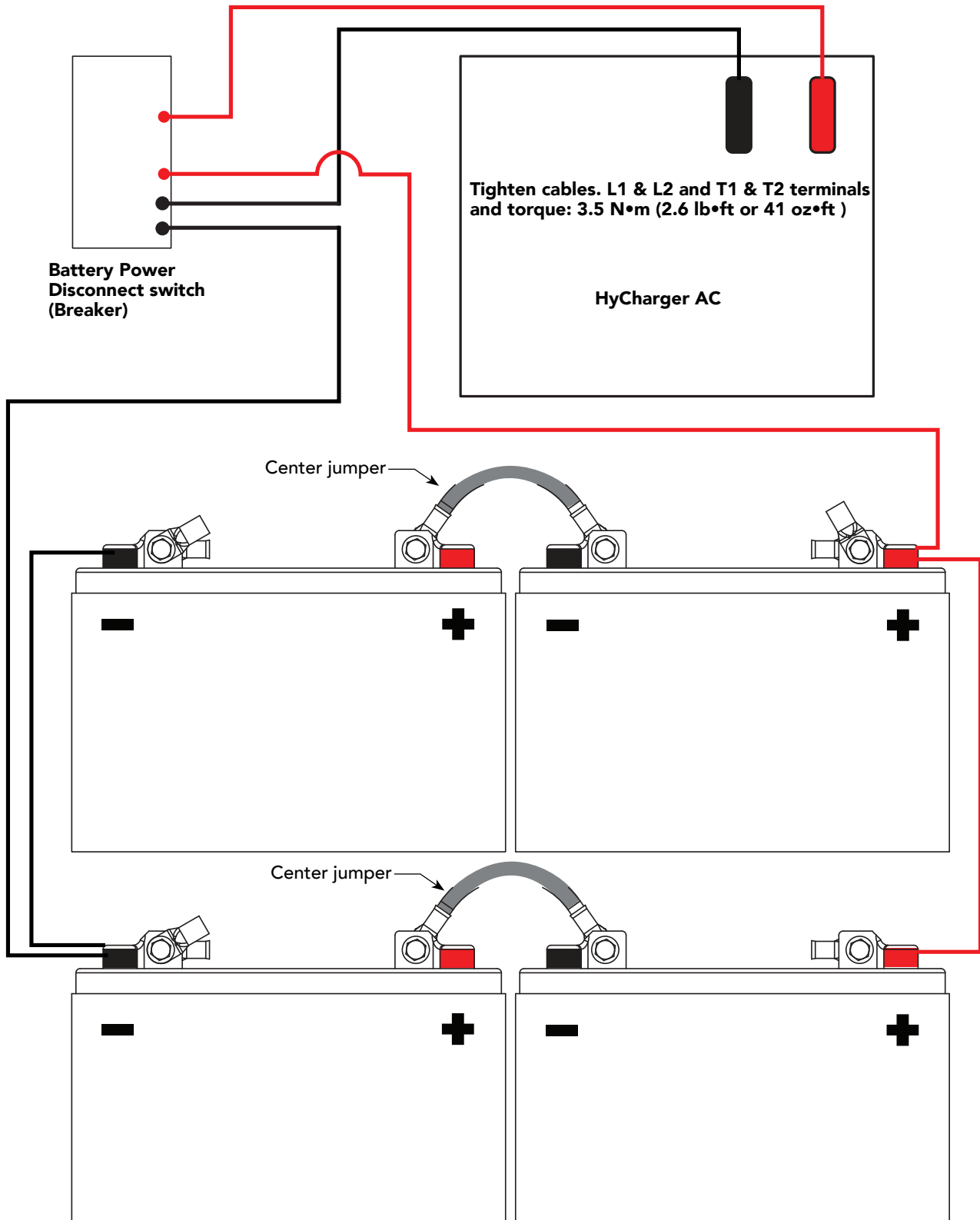

NOTE: In the AC Power Supply with HyInverter AC, the labels on the batteries face the rear of the cabinet

TN-S POWER DISTRIBUTION SYSTEM

Basic internal circuit configuration of the HyInverter AC. The following wiring diagram is for reference only to provide information regarding compatibility with power distribution systems.

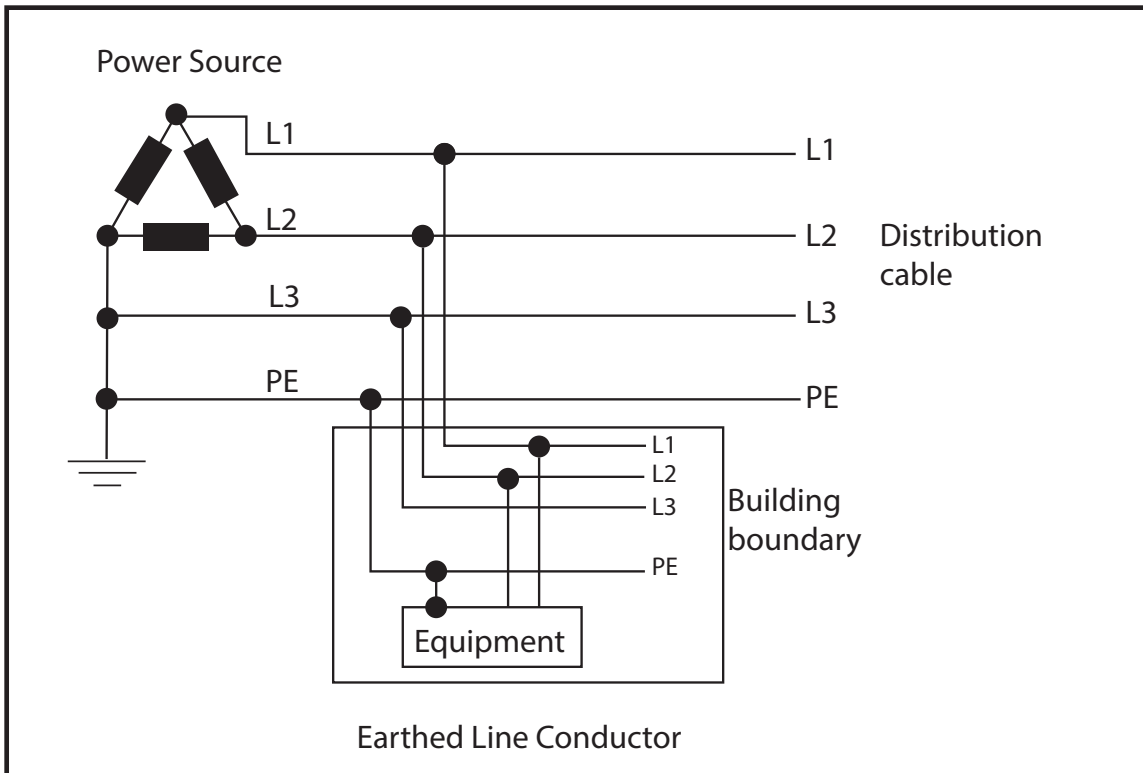
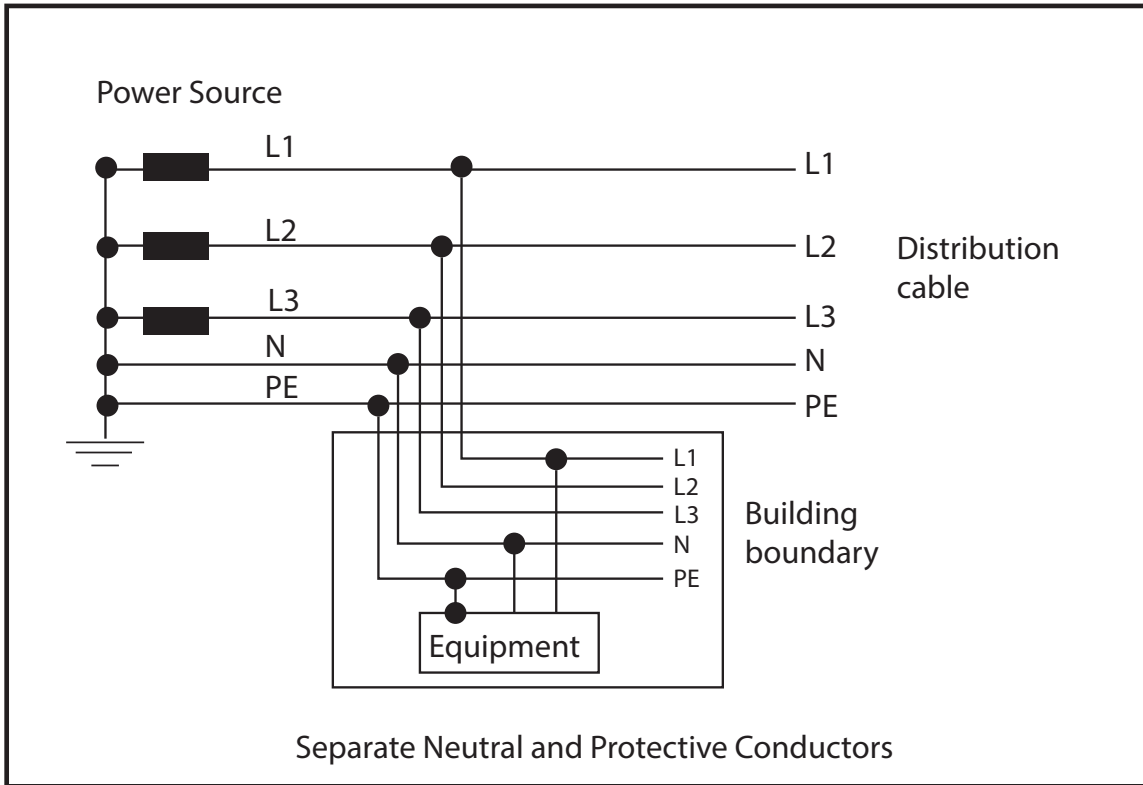

Examples of TN-S Power Distribution Systems

WARRANTY



6623 South 228th Street
Kent, Washington 98032
1-800-321-9947
www.hysecurity.com

WARRANTY

1. Warranty.

HySecurity Gate, Inc. ("HySecurity") warrants that at the time of sale each of its products will, in all material respects, conform to its then applicable specification and will be free from defects in material and manufacture.

The following additional durational warranties apply to HySecurity products, depending on whether (1) the product is purchased through an authorized HySecurity distributor and (2) whether a timely and complete product registration is submitted to HySecurity.

It is therefore important that you register your product with HySecurity, online at www.hysecurity.com/warranty, within the 60-day period described below.

1(a) HySecurity Products Purchased Through Authorized Distributors and Properly Registered

For any gate operator product that is purchased from an authorized HySecurity distributor (this excludes product purchased through internet resellers or any distributor not authorized by HySecurity), if the product registration is completed by the Dealer/Installer/End User within 60 days of the date of purchase, the following warranty terms will apply. HySecurity warrants that the product will remain serviceable for the following periods:

- Hydraulic industrial gate operators hydraulics, controls, and mechanical components: Five Years or 500,000 gate cycles (whichever occurs first) after the date of installation,
- Hydraulic wedge operator hydraulics and controls: Five Years or 500,000 cycles (whichever occurs first) after the date of installation. Wedge mechanical components: Two Years after the date of installation,
- Electromechanical Slide and Swing operators: Five Years or 500,000 cycles (whichever occurs first) after the date of installation, except single family residential usage, where the warranty term shall be Seven Years after the date the product was shipped from HySecurity,
- Electromechanical surface mount wedge operator electronics: Two Years or 500,000 gate cycles (whichever occurs first), after the date of installation,
- Electromechanical Barrier Arm Operators: Two years or 1,000,000 gate cycles (whichever occurs first) after the date of installation,

provided that the preceding Five Year warranty period in (a), (b) and (c) will not extend beyond seven years from the date that the product was shipped from HySecurity, and the Two Year warranty period in (b), (d) and (e) will not extend beyond four years from the date that the product was shipped from HySecurity.

The preceding warranty durations do not apply to the products or components described below (f-i), which have a shorter warranty period.

- Hydraulic gate operator drive wheels including XtremeDrive™ wheels and rack: Two Years from date of installation.
- AC and DC power supplies, chargers and inverters and HyNet™ Gateway: Two Years from date of installation, except batteries.
- Batteries: One Year from date of shipment from HySecurity.
- Components subject to normal wear including, but not limited to, chains, belts, idler wheels, sprockets and fuses: One Year from date of installation.

1(b) HySecurity Products Not Purchased Through an Authorized Distributor or Not Properly Registered within 60 Days

For any product that is not purchased from an authorized HySecurity distributor or for which the product registration was not completed by the Dealer/Installer/End User within 60 days of the date of purchase, the following **One-Year Limited Warranty** will apply: HySecurity warrants that the product will remain serviceable for the following periods, which begin on the date that the product was shipped from HySecurity:

- All gate operators: One Year or 100,000 gate cycles whichever comes first.
- AC and DC power supplies, chargers or inverters: One Year.
- HyNet™ Gateway: One Year.
- Hydraulic gate operator drive wheels: One Year.

1(c) Replacement Parts

HySecurity warrants that replacement parts (whether new or reconditioned) will remain serviceable for One Year from the date that the product was shipped from HySecurity or the remaining period of the Gate Operator warranty, whichever is longer.

1(d) Limitations and Exclusions Applicable to Each of the Preceding Warranties.

The preceding warranties shall not apply to equipment that has been (1) installed, maintained, or used improperly or contrary to instructions; (2) subjected to negligence, accident, vandalism, or damaged by severe weather,

wind, flood, fire, terrorism or war; or (3) damaged through improper operation, maintenance, storage or abnormal or extraordinary use or abuse. Any modification made to products will void the warranty unless the modifications are approved in writing by HySecurity in advance of the change (this exclusion does not apply to normal installation of approved accessories and/or protective devices or sensors). It is the responsibility of the distributor, installer, or End User to ensure that the software version in the product is maintained to the latest revision level.

The preceding warranties do not extend to accessories when those items carry another manufacturer's name plate and they are not a part of the base model. HySecurity disclaims all warranties for such accessory components, which carry only the original warranty, if any, of their original manufacturer. HySecurity hereby assigns its rights under such manufacturer warranties—to the extent that such rights are assignable—to Buyer.

These warranties extend to HySecurity's Distributors, to the Dealer/Installer, and to the first End User of the product following installation. They do not extend to subsequent purchasers.

2. Exclusion of Other Warranties.

The warranties contained in Section 1 are the exclusive warranties given by HySecurity and supersede any prior, contrary or additional representations, whether oral or written. Any prior or extrinsic representations or agreements are discharged or nullified. HYSECURITY HEREBY DISCLAIMS AND EXCLUDES ALL OTHER WARRANTIES—WHETHER EXPRESS, IMPLIED, OR STATUTORY—INCLUDING ANY WARRANTY OF MERCHANTABILITY, ANY WARRANTY OF FITNESS FOR A PARTICULAR PURPOSE, ANY LIABILITY, FOR INFRINGEMENT, AND ANY IMPLIED WARRANTIES OTHERWISE ARISING FROM COURSE OF DEALING, COURSE OF PERFORMANCE, OR USAGE OF TRADE.

3. Buyer's Exclusive Remedies for Any Nonconformity.

If a HySecurity product fails to conform to the warranties in Section 1, Buyer must notify and order replacement parts from the Distributor through which the product was purchased within a reasonable time and in no event more than thirty (30) days after the discovery of the nonconformity. HySecurity will investigate and, in the event of a breach, will provide, within a reasonable period of time, one of the following: (1) repair or replacement of any nonconforming products or components or (2) refund of the price upon return of the nonconforming items. HySecurity reserves the right to supply used or reconditioned material for all warranty claims. HySecurity will not be considered to be in breach of or default under this Warranty because of any failure to perform due to conditions beyond its reasonable control, including any force majeure. This warranty does not cover any incidental expenses, including fines or penalties, temporary security, labor, shipping, travel time or standby time that are incurred for inspection or replacement of any nonconforming items. As a condition of warranty coverage, warranty claims must be submitted in accordance with the procedures described on the HySecurity form, "RMA Procedures."

THE REMEDY SELECTED BY HYSECURITY IN ACCORDANCE WITH THIS PARAGRAPH SHALL BE THE EXCLUSIVE AND SOLE REMEDY OF BUYER FOR ANY BREACH OF WARRANTY.

4. Exclusion of Consequential and Incidental Damages.

HYSECURITY SHALL NOT BE LIABLE FOR ANY INCIDENTAL, SPECIAL, OR CONSEQUENTIAL DAMAGES, WHETHER RESULTING FROM NONDELIVERY OR FROM THE USE, MISUSE, OR INABILITY TO USE THE PRODUCT OR FROM DEFECTS IN THE PRODUCT OR FROM HYSECURITY'S OWN NEGLIGENCE. This exclusion applies regardless of whether such damages are sought for breach of warranty, breach of contract, negligence, or strict liability. This exclusion does not apply to claims for bodily injury or death.

5. Severability.

If any provision of this warranty is found to be invalid or unenforceable, then the remainder shall have full force and effect.

6. Proprietary Rights.

HySecurity retains and reserves all right, title, and interest in the intellectual property rights of its products, including any accompanying proprietary software. No ownership of any intellectual property rights in the products or accompanying software is transferred to Distributor, Dealer/Installer or End User.

7. Applicable Law.

This warranty will be interpreted, construed, and enforced in all respects in accordance with the laws of the State of Washington, without reference to its choice of law principles. The U.N. Convention on Contracts for the International Sale of Goods will not apply to this warranty.

SPECIFICATIONS

AC Power Supply with HyInverter AC

Compatible Operators	SlideDriver 15 SlideDriver 40 SlideDriver 50VF 2/3	StrongArm (all models)	StrongArm M30/M50	SwingRiser (single leaf models)	HydraSwing (all models)
Input Power	208/230VAC, 50/60Hz, 20A breaker				
Output Power	3000VA (Pure sine wave output)				
Surge Power	6000VA, 10 seconds				
Batteries	4 AGM 110Ah, 12VDC batteries for extended cycles (5200 W)				
Communication	Modbus RTU via RS-485 (requires up-to-date software)				
Temperature Rating	-40° to 122° F (-40° to 50° C)				
Humidity	5% to 95% relative humidity, non-condensing				
User Controls	Programmable with Smart Touch Controller				
Charger	Smart charge system conditions batteries				
Regulatory Listing	ETL Listed				
Retrofit	Existing installation sites that require UPS. Same fit and finish as existing AC-powered operator. Installs anywhere on the branch circuit from panel to protected device.				
Limited Warranty	2 year (system & electronics) , 1 year (batteries)				
Est. Shipping Weight	520 pounds / 236 kg includes batteries. Approximately 250 pounds / 113 kg without batteries				

Copyright Notice

© Copyright 2018 by HySecurity Gate, Inc.

All rights reserved. No part of this manual may be reproduced by any means (photocopier, electronic, or mechanical), without the express written permission of HySecurity Gate, Inc. Federal copyright law prohibits the reproduction, distribution, or public display of copyrighted materials without the express written permission of the copyright owner, unless fair use or other exemption under copyright law applies. Additionally, HySecurity Gate, Inc. makes no representations or warranty with respect to this manual. We also reserve the right to make changes in the products described without notice and without any obligation to notify any persons of any such revision or change.

Trademarks

SlideDriver, StrongArm, SwingRiser, StrongArm CRASH, StrongArm M30, StrongArm M50, HydraLift, HydraSwing, HydraWedge SM50, HydraSupply XL, HydraSupply, HyNet, Hy8Rely, HyInverter AC, HyCharger DC, SlideWinder, Smart Touch, S.T.A.R.T., SwingSmart DC, SlideSmart DC, StrongArmPark DC, WedgeSmart DC, Smart DC and the HySecurity logo are trademarks or registered trademarks of HySecurity Gate, Inc.

UL and UL logo are trademarks of UL LLC. ETL is a trademark of Intertek. Intertek provides the ETL Listed Mark.