

LiftMaster®

Owner's Manual

MODEL MYQ-SGC1WLM

Smart Garage Camera™

CONTENTS

Read First	2
Preparation	3
Mount the Smart Garage Camera™	4
Smart Garage Camera™ Default Settings	5
How Your Smart Garage Camera Works	6
Managing Motion Events	7
Troubleshooting	8
Need Help?	8
Replacement Parts	8
LED Status Indicators	8
One Year Limited Warranty	8
Software Agreement	8



See the Smart Garage Camera™ installation video at: support.chamberlaingroup.com

Read First



WARNING: This product can expose you to chemicals including lead, which are known to the State of California to cause cancer or birth defects or other reproductive harm. For more information go to www.P65Warnings.ca.gov

- For security and data preservation, **DO NOT USE** with mobile hotspots.
- Your camera can only be set up on an iOS or Android phone or tablet.
- Periodic firmware updates are required to keep your Smart Garage Camera™ functioning.
- Router results may vary.



Back to **CONTENTS** on the previous page

Preparation

For Indoor Use Only

Check Your View Before You Mount:

- Power up the Smart Garage Camera™ in your chosen mounting area.
- Smart Garage Camera™ is in reach of the included 10' (3 m) Micro-USB cable and a power outlet.
- Hold the camera at your chosen mounting area, free from visual and metal obstructions. Check your mobile device view shows what you want to see before you mount.
- If using the magnetic mounting base screws for a surface mount, mark the surface area to install.
- Power off the Smart Garage Camera™ by unplugging it to begin a surface mount.

What's In the Box

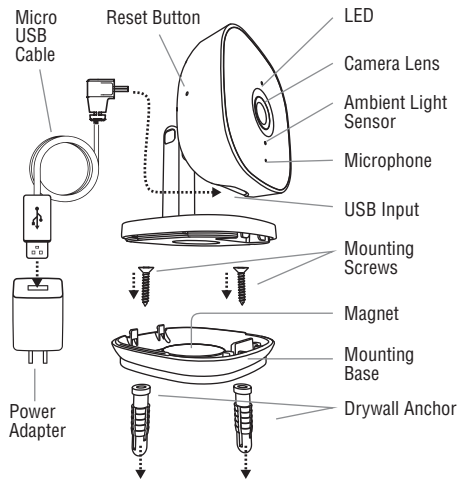

Connect Your Smart Garage Camera™

Use the myQ® App, your mobile device, and your router to control your Smart Garage Camera™.

Before You Start:

1. Be sure your mobile device's Wi-Fi® is on and displays a strong signal where the camera will sit.
2. Check that Bluetooth is enabled on your mobile device.
3. Enable Location Services on your mobile device.
4. Download the [myQ® App](#).
TIP: If you already have the myQ® App, confirm you have the latest version to optimize your myQ® experience.
5. Create or sign in to your account.
6. Add your Smart Garage Camera™ to your myQ® account.

Connecting To A New Router

NOTE: Use this information only if you are installing a home router for the first time or replacing a home router and you have an existing Smart Garage Camera™.

1. After you install a home router, add your Smart Garage Camera™ to your myQ® account as a new device.
2. Tap your Smart Garage Camera™ | **Gear** icon , tap **Settings** and select your preferences.

Mount the Smart Garage Camera™

Items You May Need:

- Ladder
- Philips Screw Driver
- Drill and Drill Bit
- Hammer

Choose from Options A or B:

Option A: Magnetically Set to Garage Door Opener

1. Place the Smart Garage Camera™ magnetic mounting base on the garage door opener, with lens facing what you want to see.
2. Wrap the cable around the mounting base.

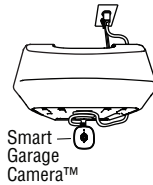

Option B: Surface Mount

1. Remove the magnetic mounting base from the Smart Garage Camera™.
2. Position the magnetic mounting base at the desired installation surface.
3. Insert screws provided with drywall anchors, as needed.
4. Reassemble the Smart Garage Camera™ over the magnetic mounting base.
5. Position the Smart Garage Camera™ with lens facing what you want to see.

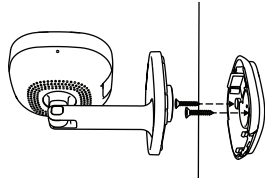

Set Up Additional Cameras

You can add multiple Smart Garage Cameras™.

1. In myQ® App | **Devices**, click the **Add** icon + and add another camera.

TIP: Use the name of the room or location your camera will be mounted for easy identification.

Smart Garage Camera™ Default Settings

Your Smart Garage Camera™ comes with these default settings that can be customized to your preference in the myQ® App.

Tap your Camera | **Gear** icon  to access settings.

Setting	Default	What It Does
Camera Name	None	Stores a name you use to identify it among other devices on your myQ® account.
Firmware	None	Displays the version running, and notifies when it becomes out of date, waiting for you to accept updates.
Talk Back Volume	Control with the slider	Indicates volume strength when you use Push to Talk , talking through your mobile device to the person in your camera's view.
Motion Detection		Connecting to Wi-Fi and connecting to the myQ® App. When set to On , this will record video and create a Motion Event (video clip, recording instance) when the motion sensor is triggered. NOTE: You must have a Video Storage Plan to retain motion events for later viewing. Follow the myQ® App instruction for trial use when you tap View Motion Events or see support.chamberlaingroup.com for more information.
Motion Recording	Off	
Sensitivity	Medium	This adjusts the sensitivity of the motion sensor.
Night Vision (IR)	Auto	Active infrared illumination to define the garage view in darkness. On: Night Vision stays on during daylight or night time, but only shows view in black and white. Auto: Night Vision turns on as daylight changes to night time, allows full color video during daylight. Off: No Night Vision, view requires light. NOTE: If the Smart Garage Camera™ is facing a window, the view can produce glare when Night Vision is On . Try turning off Night Vision or changing the camera position.
Rotation	Regular	The camera view is right-side up (regular), with base on top of a surface. Mount the camera upside-down, and select Flip to rotate the view 180 degrees vertically to the mount.

Setting	Default	What It Does
Camera Location	Unassigned	Where the camera sits in use. Smart Garage Camera™ is designed to monitor motion detected in front of the camera, such as garage door travel, and stored motion events when you have a Video Storage Plan.
Disable Microphone	Off	The camera's microphone defaults to On . When you disable microphone (On) the camera records and monitors events, but only video and not sound.
View Motion Events	Requires Video Storage Plan	Set up a Video Storage Plan and then turn on Motion Detection settings to use this feature. Watch past time-stamped motion events, as well as download and share the motion event.

Resetting Your Camera to Factory Default Settings

1. Use a pin to hold the Reset Button on the camera head side for 15 seconds. The LED light turns off, and then blinks, indicating the camera is reset to factory default settings. See [What's In the Box](#) on page 3 for more information.

How Your Smart Garage Camera Works

Each time your garage door opens or closes, the Smart Garage Camera™ records that motion event for as long as it detects motion. You can monitor live streaming activity in your garage from anywhere using your mobile device. With a video storage plan, you can watch past time-stamped motion events, and also download and share the motion event.

Watch Smart Garage Camera™ Live Streaming

1. From myQ® App, tap your camera, and the camera screen with your live streaming view displays.

View Motion Events

After you [enable motion event recordings](#), your camera captures a recording, or motion event each time your garage door opens, closes, or motion is detected in front of the camera.

1. From myQ® App, tap your camera and the camera screen with your live streaming view displays.
2. Tap **View Motion Events**. Past motion events display from newest to oldest.
3. Tap the motion event you want to play. The video screen displays.
4. Tap the Play  icon.
5. Tap the **Back <** arrow. The video displays "watched".



NOTE: If you have multiple cameras, a badge displays with the first letter of each camera's name to the right of the motion event.

To filter by camera name:

1. Tap the filter icon on the top right corner.
2. Select the camera motion events you want to see.
3. Tap the **Back <** arrow.

Push to Talk

Use your Smart Garage Camera™ speaker to talk to people in live streaming view.

1. Tap the **Speaker** icon  on.
2. Press and hold the **Microphone** icon  to talk. The **Microphone** icon highlights and the message, "Speak into phone" displays. Stop pressing when you stop talking.

Updating Firmware

When your Smart Garage Camera™ displays that the firmware version "is out of date," the **Update Available** button displays for you to upgrade new features and performance improvements.

To update firmware:

1. Stand in front of your Smart Garage Camera™ to see the LED status and tap **Update Available**. The firmware updates and the LED status indicator is purple. **NOTE:** DO NOT unplug the camera during the update. It will be offline and not viewable during the update.
2. After 5 to 10 minutes, the status in your Camera Settings is "up to date."

Enabling Motion Event Recordings

Motion events as stored video clips are accessible **only** when you have a Video Storage Plan. If you have not already done so, follow the App instructions to activate a plan. Tapping the **View Motion Events** button will also present a trial use of motion event recording for a limited time.

To turn on your motion detected recordings in your garage:

1. From the myQ® App | your selected camera | **Gear** icon , tap **Settings | Motion Detection**.
2. Turn on **Motion Recording**.
3. Slide **Sensitivity** level from lowest to highest for best recording definition.
4. Tap the **Back <** arrow.

Setting Alerts

After you [enable motion event recordings](#), you can set alerts.

1. Tap myQ® App | **Alerts** and follow the in-app instruction.

Deleting Your Smart Garage Camera





You can remove your Smart Garage Camera™ from your myQ® account, and add it back later.

1. Tap the **Gear** icon  next to the camera you wish to delete.
2. Tap **Delete Camera**.
3. Tap **Delete**. The camera is removed from your Devices screen. Test the views of the other cameras in your account to assure they provide the view you need.



Managing Motion Events

Depending on your Video Storage Plan, you can:

- **Download**  motion events to your mobile device's storage
- **Share**  motion events
- **Delete**  a single motion event at a time
- **Bulk delete**   all captured motion events, and
- **Mark as unwatched** on select motion events.

NOTE: Motion Recording must be on for you to see your motion events. See [Enabling Motion Event Recordings](#) on the previous page for more information.



Downloading Motion Event Recordings

You can download your motion events to your mobile device's local storage.

1. From Camera | **View Motion Events** in myQ®, tap the motion event you want to download.
2. Tap the **Download** icon  next to the playback bar.
3. Find your downloaded motion event in Gallery for Android and Photos for iOS.

[Back to Top](#)



Share Motion Event Recordings

1. From Camera | **View Motion Events** in myQ, tap the motion event you want to share.
2. Tap the Options dots . Choose your method of sharing and follow myQ App.
3. Tap the **Share** icon .
4. Choose your method of sharing and follow myQ® App.



[Back to Top](#)

Delete Motion Event Recordings

To delete a single motion event:

1. From Camera | **View Motion Events** in myQ®, tap the motion event you want to delete.
2. Tap the Options dots .
3. Tap the single **Delete** icon .

To delete multiple motion events:

1. From Camera | **View Motion Events** in myQ®, tap any motion event you want to delete.
2. Tap the Options dots  next to the motion event.
3. Tap the **Bulk Delete** icon . Tap your selection. "Are You Sure?" displays.
4. Tap **Yes**.
5. Tap the **Back**  arrow.

[Back to Top](#)

Select a Motion Event to Mark as Unwatched

1. From Camera | **View Motion Events** in myQ®, tap any motion event marked "watched".
2. Tap the Options dots  next to the motion event.
3. Tap **Mark as unwatched**. "watched" is removed.

[Back to Top](#)



[Back to CONTENTS](#) on page 1

Troubleshooting

Smart Garage Camera™ is not in the router list

1. Assure your camera is powered on. LED is solid green. See [LED Status Indicators](#) below.
2. Select your router and enter your router's password. Your camera displays in the router. list, and you can set up. Or if not:
3. For firewalls, if you have a one router that supports 2.4GHz and 5GHz, the passwords for each may be different. Try either or both passwords to resolve.
4. Move the Smart Garage Camera™ closer to your home router, recommended distance no more than 3 '.

Camera is offline

- Try unplugging and plugging in the power cord. The camera comes back online. See [LED Status Indicators](#) below for more information.

Motion Event recording is not displaying

- Assure you have a Video Storage Plan and [Motion Recording](#) settings are **On**.
- Motion event recordings are stored for the number of days your Video Storage Plan specifies. You can [download motion event recordings](#) to save video to your mobile device's local storage.

Live streaming video is black and white

- When you turn Night Vision on manually during daylight, your recording displays in black and white. [Set Night Vision](#) to Auto for best performance.

Need Help?

Go to: support.chamberlaingroup.com

Replacement Parts

Power Adapter Kit..... SGC-PK

Mounting Kit SGC-MK

© 2020 LiftMaster

All Rights Reserved

Wi-Fi® is a registered trademark of Wi-Fi Alliance

114-5422-000

LED Status Indicators

What You See	What It Means
Solid White	Smart Garage Camera™ is powering up.
Flashing Blue	Ready to be set up in the myQ® App.
Solid Blue	Connected to your mobile device. You are not yet connected to the Internet. If this persists after setup, check your home router and Internet.
Flashing Blue and Green	Connecting to Wi-Fi and connecting to the myQ® App.
Flashing Green	Connected to the router, but there is no internet.
Solid Green	Connected to the myQ® App.
Flashing Purple	Receiving firmware updates.

One Year Limited Warranty

The Chamberlain Group, Inc. warrants to the first consumer purchaser of this product that it is free from defect in material and/or workmanship for a period of 1 year from the date of purchase.

Software Agreement

Use of this product and the software embedded within the product are subject to the copyright notices, terms, and conditions accessible in the myQ® App. Open the App Menu and select **Help**, and then **License and Terms of Use** for more information.

NOTICE: This device complies with part 15 of the FCC rules and Innovation, Science and Economic Development Canada license-exempt RSSs. Operation is subject to the following two conditions: (1) this device may not cause harmful interference, and (2) this device must accept any interference received, including interference that may cause undesired operation.

Any changes or modifications not expressly approved by the party responsible for compliance could void the user's authority to operate the equipment.

This device must be installed to ensure a minimum 20 cm (8 in.) distance is maintained between users/bystanders and device.

This device has been tested and found to comply with the limits for a Class B digital device, pursuant to part 15 of the FCC rules and Industry Canada ICES standard. These limits are designed to provide reasonable protection against harmful interference in a residential installation. This equipment generates, uses and can radiate radio frequency energy and, if not installed and used in accordance with the instructions, may cause harmful interference to radio communications. However, there is no guarantee that interference will not occur in a particular installation. If this equipment does cause harmful interference to radio or television reception, which can be determined by turning the equipment off and on, the user is encouraged to try to correct the interference by one or more of the following measures:

- Reorient or relocate the receiving antenna.
- Increase the separation between the equipment and receiver.
- Connect the equipment into an outlet on a circuit different from that to which the receiver is connected.
- Consult the dealer or an experienced radio/TV technician for help.

The device for operation in the band 5150-5250 MHz is only for indoor use to reduce the potential for harmful interference to co-channel mobile satellite systems.



Back to [CONTENTS](#) on page 1