

QuickStart for the Model MJ/MH/MHS/MGJ Door Operator

This QuickStart is intended to highlight a typical installation. These instructions are not intended to be comprehensive. Since each application is unique, it is the responsibility of the purchaser, designer, installer and end user to ensure that the total door system is safe for its intended use. Please consult the manual and/or a qualified technician for further information.

NOTE: Intended for Professional Installation Only. Visit www.liftmaster.com to locate a professional installing dealer in your area.

AN ENTRAPMENT PROTECTION DEVICE IS HIGHLY RECOMMENDED

INSTALLATION

Determine Mounting Location for Operator

Wall Mount: The operator should generally be installed below the door shaft, and as close to the door as possible.

Bracket Shelf Mount: The operator may be mounted either above or below the door shaft.

NOTE: The optimum distance between the door shaft and operator drive shaft is between 12 - 15 inches.

Install the Operator

- 1 Place door sprocket on the door shaft. **Do not insert the key at this time.**
- 2 Place drive sprocket on the appropriate side of the operator. **Do not insert the key or set screw at this time.**
- 3 Wrap chain drive around door sprocket and join roller chain ends together with master link.
- 4 Raise operator to approximate mounting position and position chain over operator sprocket.
- 5 Raise or lower operator until the chain is taut (not tight). Make sure the operator output shaft is parallel to door shaft and sprockets are aligned. When in position, secure the operator to wall or mounting bracket.
- 6 Align sprockets, insert key into keyway, and secure.
- 7 Place hand chain around hand chain wheel (if provided).

Power and Ground Wiring Connections

- 8 Run the power wires through the power wiring conduit hole in the electrical box enclosure. Connect the power to the operator. Connect the earth ground to the ground screw in the electrical box enclosure. **Follow ALL local electrical codes.**
- 9 Run control wires through the control wiring conduit hole in the electrical box enclosure. **Follow ALL local electrical codes.**

Adjustments

- 10 Adjust the limit switches to open and close door properly. Make sure the limit nuts are positioned between the limit switches before proceeding with adjustments.
- 11 Remove cotter pin from nut on the clutch shaft. Back off clutch nut until there is very little tension on the clutch spring. Tighten clutch nut gradually until there is just enough tension to permit the operator to move the door smoothly but to allow the clutch to slip if the door is obstructed. Reinstall cotter pin when finished.

Troubleshooting instructions inside cover of operator.

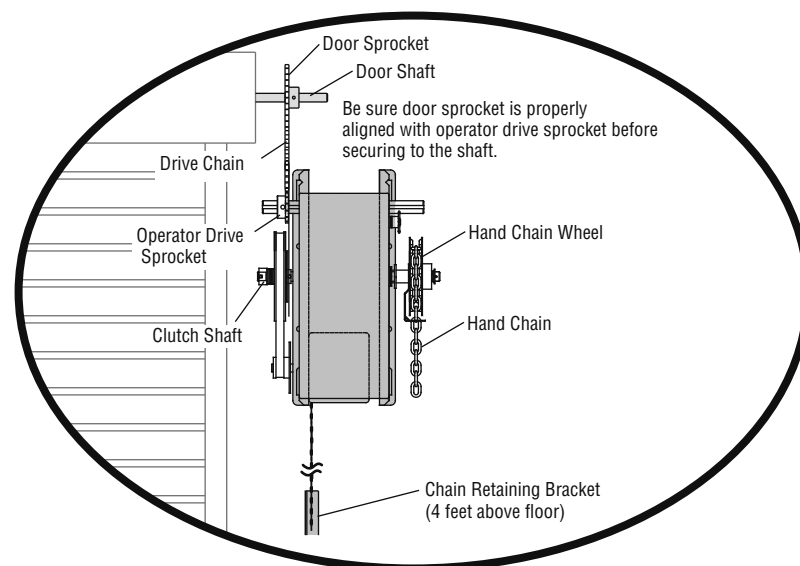
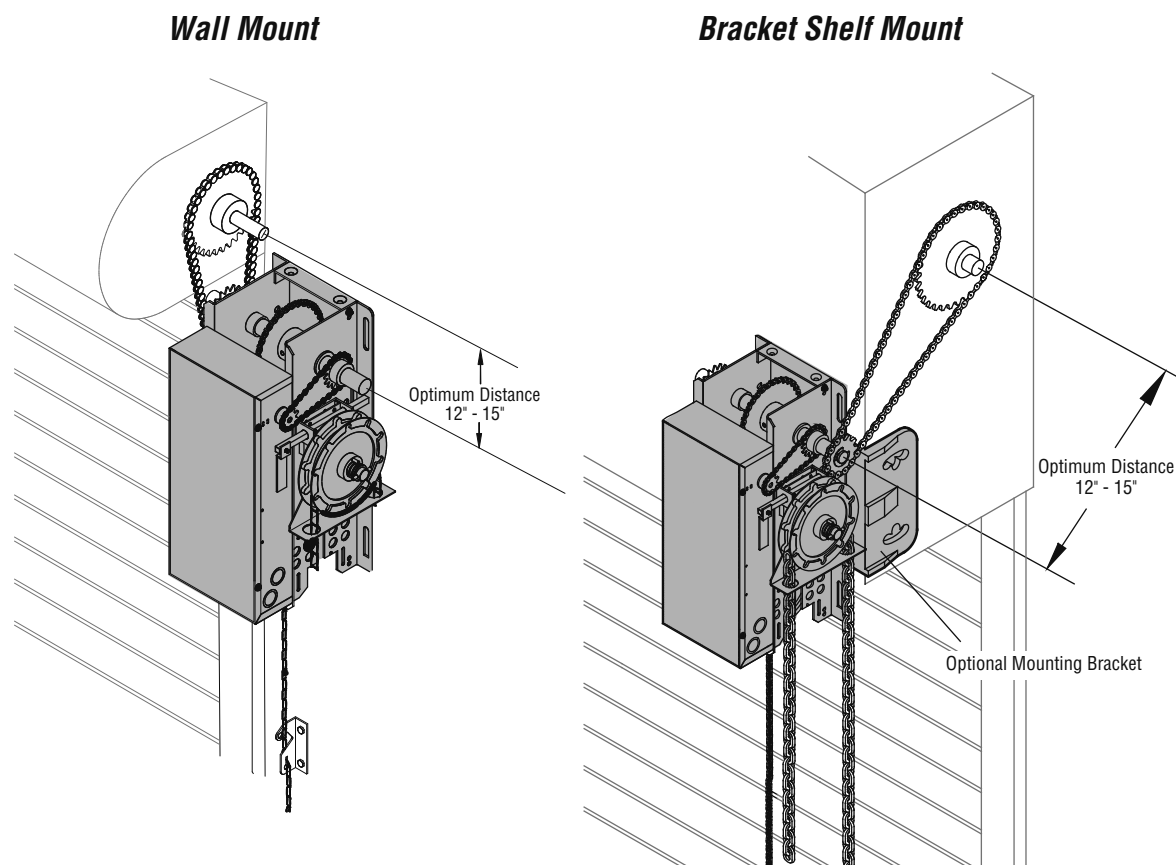

MEDIUM DUTY LOGIC

MANUAL DISCONNECT

This operator has provisions for manually operating the door in case of emergency or power failure. Refer to the appropriate instructions below for your model operator.



Turn off power to the operator BEFORE manually operating your door.

Model MH

These operators are equipped with a manual hoist. An electrical interlock will disable the electrical controls when the hoist is used.

- 1 Pull the disconnect chain (sash chain) to engage the hoist mechanism. The disconnect chain may be locked in position by slipping the end through the keyhole of the chain keeper mounted on the wall.
- 2 Operate the door in the desired direction by pulling on one side or the other of the continuous loop hoist chain.
- 3 The disconnect chain must be released from the chain retaining bracket before the door will operate again electrically.

Model MHS

This operator includes both a floor level disconnect sash chain to disconnect the door from the door operator and a disconnect sash chain with manual hoist operation that electrically disables the operator controls.

- 1 Refer to Model MH instructions for hoist operation.
- 2 Refer to Model MJ instructions for manual operation.

When operator is disconnected by manual operation chain, hoist and electrical operation will not function.

Models MJ and MGJ

This operator has a floor level disconnect chain to disconnect the door from the door operator.

- 1 To disengage, pull the chain and secure in the disengaged position by slipping the end through the keyhole bracket mounted on the wall. Or if emergency egress device is used, pull handle to disengage operator from door.
- 2 The door may now be pushed up or pulled down manually.
- 3 Release the disconnect chain or reset the emergency egress device to operate the door again electronically.

ELECTRICAL INTERLOCK WITH HOIST FOR MODELS MH AND MHS

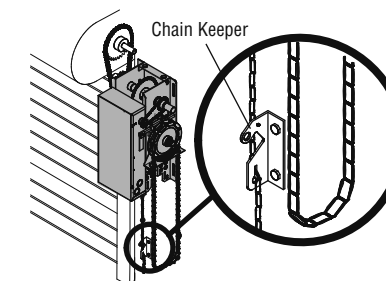

MANUAL DISCONNECT FOR MODELS MJ

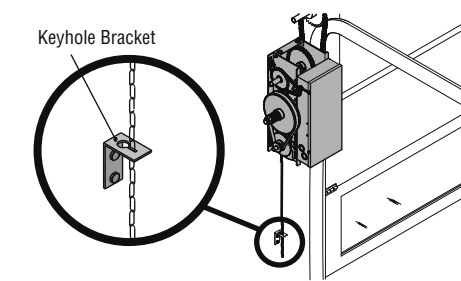

QuickStart for the Model MJ/MH/MHS/MGJ Door Operator

MEDIUM DUTY LOGIC

This QuickStart is intended to highlight a typical installation. These instructions are not intended to be comprehensive. Since each application is unique, it is the responsibility of the purchaser, designer, installer and end user to ensure that the total door system is safe for its intended use. Please consult the manual and/or a qualified technician for further information.

NOTE: Intended for Professional Installation Only. Visit www.liftmaster.com to locate a professional installing dealer in your area.

AN ENTRAPMENT PROTECTION DEVICE IS HIGHLY RECOMMENDED

LIMIT SWITCHES

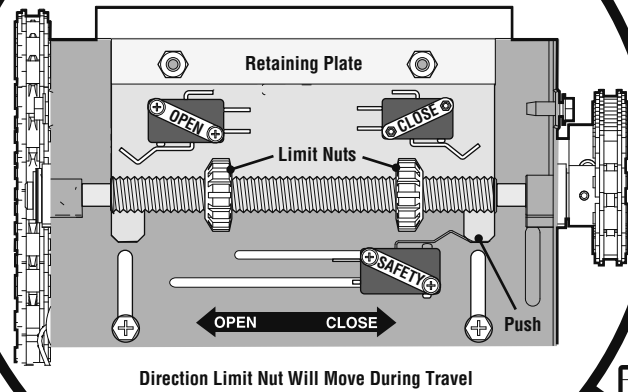

POWER WIRING

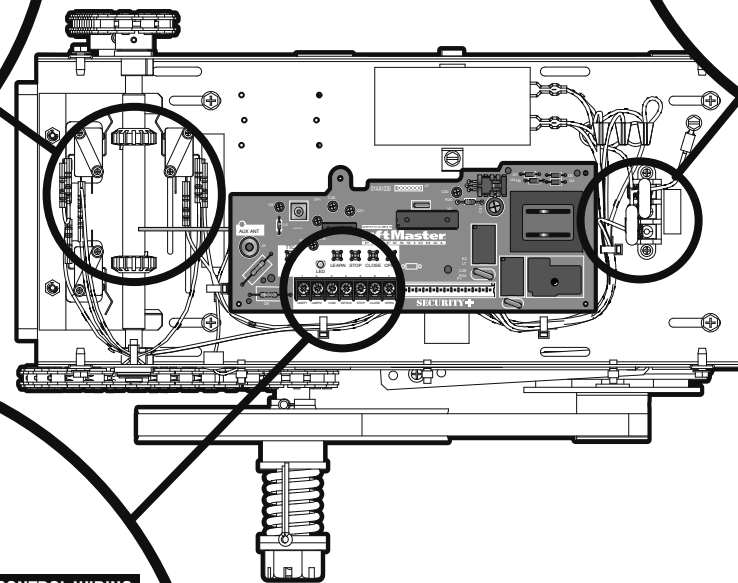
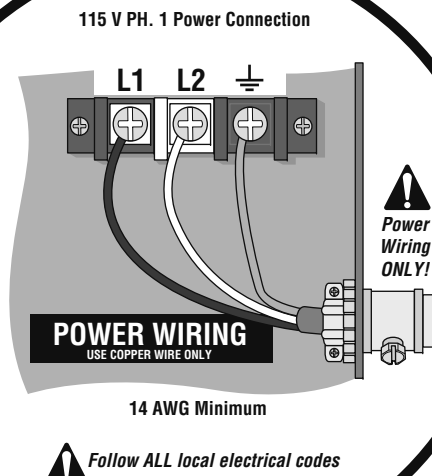

CONTROL WIRING

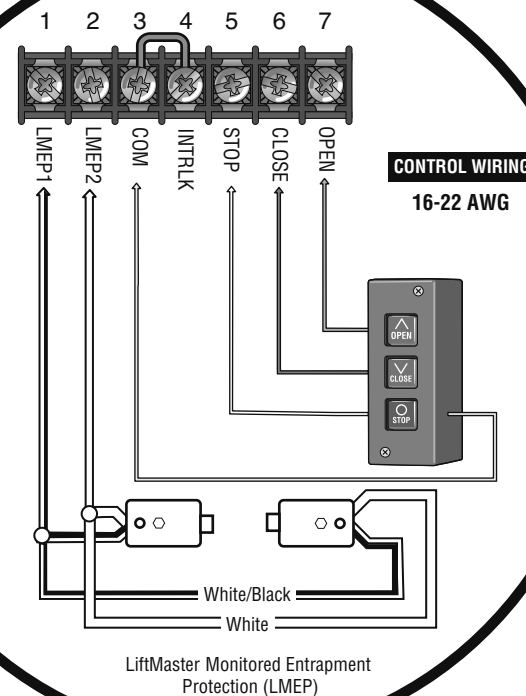

PROGRAMMING

Requires LiftMaster Monitored Entrapment Protection (LMEP) device. See installation manual for LiftMaster Monitored Entrapment Protection (LMEP) device selection and installation.

REMOTE CONTROLS

Built in 315 MHz radio receiver permits as many as 20 Security+® remote controls or dip switch remote controls in any combination.

Single Button Remote Control

1 Press and release the LEARN button (LED will light).

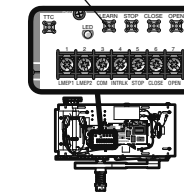

2 Press and hold the button on the remote control until the LED flashes rapidly, then release to complete programming (LED will go out).

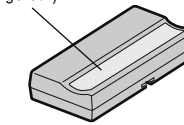

Repeat steps 1 and 2 for additional remote controls.

To Erase All Remote Controls

1 Press and hold the LEARN button (over 5 seconds) until the LED goes out. All programmed remote controls will be erased.

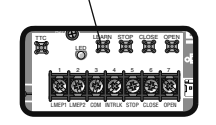

3-Button Remote Control to Operate as a Wireless 3-Button Control Station

NOTE: The feature will use 3 of the 20 memory channels in the operator.

1 Press and release the LEARN button (LED will light).

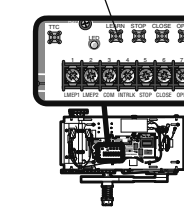

2 Press the desired button on the logic board (OPEN, CLOSE or STOP). Release both buttons.

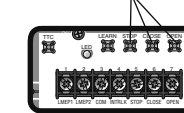

3 Press and hold the desired button of the remote control until LED flashes rapidly, then release.

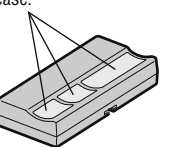

Repeat steps 1 through 3 to program additional buttons.

TIMER-TO-CLOSE

Timer-to-Close feature enables the operator to close from the open limit after a preset time, adjustable from 5 to 60 seconds.

To Program

Begin with the door in fully closed position.

1 Press and release the LEARN button (LED will light).



2 Press and release the TCC button.

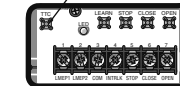

3 Every press and release of the STOP button will add 5 seconds to the Timer-to-Close. Example: 30 second TTC = 6 presses of the STOP button.

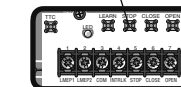

4 Press and release the TTC button to exit programming mode. The LED will flash once per 5 seconds of timer setting.

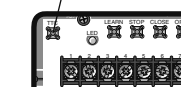

The TTC will become active after completion of the next open cycle.
NOTE: The LED does not indicate that timer is running.

Timer Defeat

The TTC can be temporarily disabled by pressing a STOP button. TTC will become enabled after the next open command.

To Verify the Timer-to-Close (TCC) Setting

1 Press and hold the LEARN button (LED will light).

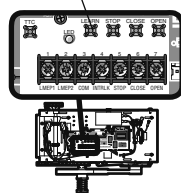

2 Press and release the TCC button.

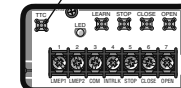

3 Press and release the TTC button a second time. The LED will flash once per 5 seconds of timer setting.

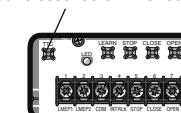

Clear the Timer-to-Close (TCC)

1 Press and release the LEARN button (LED will light).

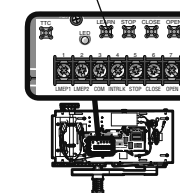

2 Press and hold the TCC button for 6 seconds.

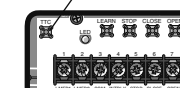

3 Release the TTC button (LED will go out). The TTC will no longer be active.

