



ULT-MVP-2™

Multi-Voltage Vehicle Loop Detector

Two Channel with Direction Indication



Instruction Manual

The ULT-MVP-2 two channel vehicle loop detector senses metallic objects near an induction loop. This detector automatically adjusts from 12 VDC up to 240 VAC which eliminates the installer's need to match available power to an appropriately rated vehicle detector. The ULTRAMETER™ display makes set-up easy by displaying the optimum sensitivity setting required to detect a vehicle positioned near the loop. Ten sensitivity settings allow for fine adjustment of the detection level. The ULT-MVP-2 provides relay contact outputs indicating vehicle presence for each channel separately and AB logic for direction indication. The relay output for each channel may be set for pulse or presence, or the EMX exclusive feature, Detect-on-Stop™ (DOS®). The ULT-MVP-2 features automatic sensitivity boost (ASB) and infinite or normal (5 minute) presence. Four frequency settings provide flexibility in preventing crosstalk in multi-loop applications.

Cautions and Warnings



This product is an accessory or part of a system. Install the ULT-MVP-2 according to instructions from the gate or door operator manufacturer. Comply with all applicable codes and safety regulations.

Specifications

Power	12-60 VDC or 12-240 VAC (48-62 Hz)
Draw Current (Standby/Detect)	25 mA/50 mA
Loop Frequency	4 settings (low, med-low, med-hi, high)
Loop Inductance	20-2000 μ H (Q factor \geq 5)
Surge Protection	Loop circuitry protected by surge suppressors
Channel 1 & 2 Relay	SPDT relay contacts (form C)
Contact Rating (Resistive Load)	2 A @ 30 VDC, 0.5 A @ 125 VAC
Operating Temperature	-40° to 180°F (-40° to 82°C) 0 to 95% relative humidity
Environmental Rating	IP30
Connector	11 pin male connector (JEDEC B11-88) compatible with DIN rail mount socket or wire harness
Dimensions (L x W x H)	73 mm (2.9") x 38 mm (1.2") x 78 mm (3.1")

Ordering Information

- ULT-MVP-2U Two channel multi-voltage vehicle loop detector, US wiring
- ULT-MVP-2E Two channel multi-voltage vehicle loop detector, EU wiring
- HAR-11 11 position harness, 3' of wire
- LD-11 11 pin DIN rail socket, black, wide base
- LD-11B 11 pin DIN rail socket, black, narrow base
- PR-XX Lite preformed loop (XX – specify size)
- TSTL Test loop, troubleshooting tool

Wiring Connections

Description	US DIN Rail Socket (for ULT-MVP-2U)	EU DIN Rail Socket (for ULT-MVP-2E)	Harness Wire
Power (12-240 VDC/AC)	1	1	Black
Power (12-240 VDC/AC)	2	2	White
Channel 2 – NO* (normally open contact)	3	7	Orange
Shield – Earth Ground	4	9	Green
Channel 1 – COM* (common contact)	5	11	Yellow
Channel 1 – NO* (normally open contact)	6	10	Blue
Loop - Channel 1	7	3	Gray
Loop - Channel 1	8	4	Brown
Channel 2 – COM* (common contact)	9	8	Red
Loop - Channel 2	10	5	Pink
Loop - Channel 2	11	6	Violet

* Contact rating: 2A @ 30 VDC, 0.5A @ 125 VAC

US DIN Rail Socket

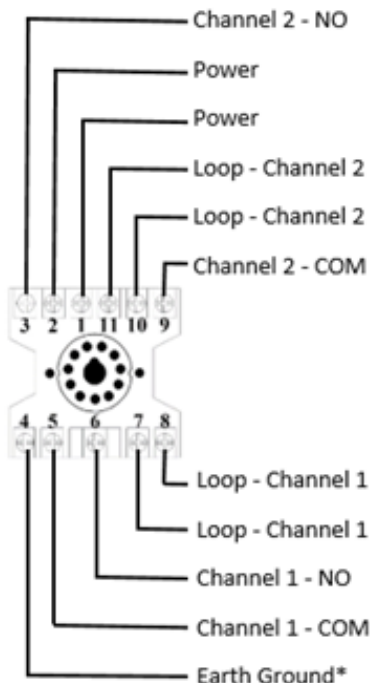

OR 11 Wire Harness

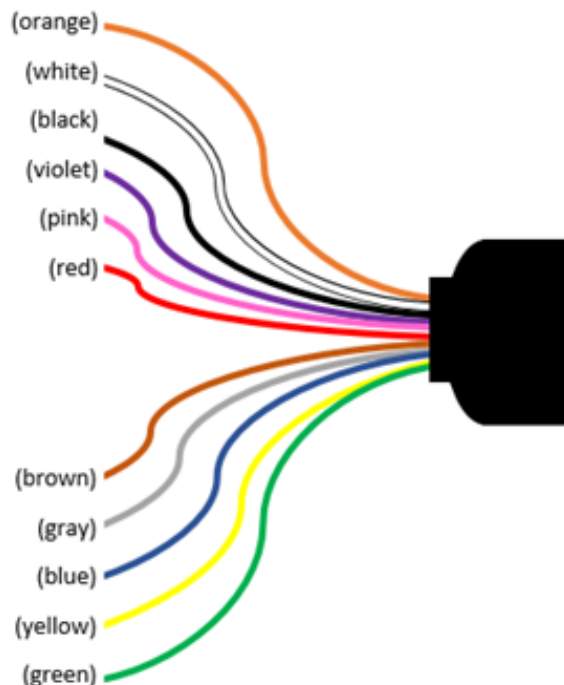

***Must be connected to approved earth ground for surge protection to be effective**

Settings & Display

1. Channel Set-Up / Reset Button

Press and release to enter/exit channel set-up mode and re-initialize the detector.

2. Sensitivity Setting

The 10-position rotary switch allows for adjustment of detection threshold. The sensitivity level increases from position 0 (lowest setting) through 9 (highest setting). Typical applications require a setting of 3 or 4. The rotary adjustment must be set to a specific/whole number, during channel set-up mode. There are no half settings.

3. Channel 1 Detect Indicator

<i>Presence Detected</i>	on
<i>No Presence</i>	off
<i>Loop 1 Fault</i>	flashing

4. Channel 2 Detect Indicator

<i>Presence Detected</i>	on
<i>No Presence</i>	off
<i>Loop 2 Fault</i>	flashing



5. ULTRAMETER™ Display

The display shows the sensitivity setting required to detect a vehicle near the loop. To use this feature, observe the display while a vehicle is moving into position near the loop, note the number displayed, then adjust the sensitivity setting to the displayed position. The display will adjust from 9 for a weak signal to 0 for a very strong signal. The effects of cross-traffic interference can be observed on the display when the sensing area is vacant.

- During normal operation, when a vehicle is not on or near the loop, the display will show a green segment rotating counterclockwise.
- When a loop fault occurs, the display will show one segment defined in the Loop Fault Indicator table below to describe the loop fault.
- When the channel set-up button is pressed, the current settings for the channel selected by DIP switch 1 will flash on the ULTRAMETER™ display according to the Channel Settings table.

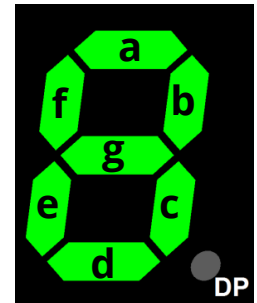

Loop Fault Indicator

Segment	Fault Description
a	Channel 2 frequency range error
b	Channel 2 frequency too high (>150 kHz)
c	Channel 2 frequency too low (<20 kHz)
d	Channel 1 frequency range error
e	Channel 1 frequency too low (<20 kHz)
f	Channel 1 frequency too high (>150 kHz)
DP	ABS on or settings changed

Channel Settings

Setting		Displayed
Channel #	C	1 or 2
Sensitivity	S	0-9
Loop Frequency	F	xxx kHz
Pulse/Presence	P u	0 = presence or 1 = pulse
Detect-on-Stop™	d	0 = off or 1 = on

6. DIP Switch

The DIP switch settings are explained on the next page.

Channel Select	DIP Switch 1
<i>Channel 2</i>	on
<i>Channel 1</i>	off

Channel select, DIP switch 1, determines which channel's sensitivity level is displaying on the ULTRAMETER™ display. This switch also controls which channel set-up will be modified when pressing the channel set-up button.

Pulse/Presence	DIP Switch 2
<i>Pulse</i>	on
<i>Presence</i>	off

DIP switch 2 allows the output relay to be configured for **presence** or one second **pulse** on entry operation. When set to presence, the output relay remains activated while the vehicle is present on the loop. This mode may be set separately for each channel. **AB Logic mode does not work in Pulse mode.**

Detect-On-Stop™	DIP Switch 3
<i>DOS® On</i>	on
<i>DOS® Off</i>	off

The **Detect-On-Stop™ (DOS®)** feature requires that a vehicle must come to a complete stop over the loop for a minimum of 1-2 seconds before the relay activates. This mode may be set separately for each channel. **Do not use DOS® feature for reversing loop applications.**

AB Logic (Directional Mode)	DIP Switch 4
<i>AB Logic On</i>	on
<i>AB Logic Off</i>	off

AB Logic mode is capable of determining the direction of travel. If a vehicle enters the channel 1 loop and then proceeds to the channel 2 loop, the channel 1 relay contact will close only when the vehicle crosses over the channel 2 loop and vice versa. This mode is not channel specific and if turned on applies to both channel 1 and 2.

Presence	DIP Switch 5
<i>Normal</i>	on
<i>Infinite</i>	off

Infinite presence mode causes the output to remain in detect as long as the vehicle remains on the loop. **Normal** presence mode causes the output to reset after 5 minutes. This mode is non-channel specific and if turned on is applied to both channel 1 and 2. **Do not use Normal presence mode for reversing loop applications.**

Automatic Sensitivity Boost	DIP Switch 6
<i>ASB On</i>	on
<i>ASB Off</i>	off

The **Automatic Sensitivity Boost** causes the sensitivity to increase following initial detection. This feature is useful to prevent dropout when detecting high-bed vehicles. The sensitivity returns to its normal setting after the vehicle exits the loop. This mode is not channel specific and if turned on is applied to both channel 1 and 2. The decimal point on the ULTRAMETER™ display indicates ASB is on.

Frequency Settings	DIP Switch	
	7	8
<i>Low</i>	on	on
<i>Medium Low</i>	on	off
<i>Medium High</i>	off	on
<i>High</i>	off	off

DIP switches 7 and 8 are used to assign the loop operation frequency. The primary purpose of the **frequency setting** is to allow the installer the ability to set different operating frequencies for multi-loop installations and is recommended to prevent crosstalk/interference from multiple loops. Frequency is non-channel specific and is applied to both channel 1 and 2.

Loop Installation

NEW SLAB POUR

Ty-wrap 1-1/4" PVC pipe to the top of the rebar in the size and configuration of the loop (ex. 4' x 8'). Then ty-wrap the loop to the top of the PVC frame. This stabilizes the loop during the pour and separates it from the rebar.

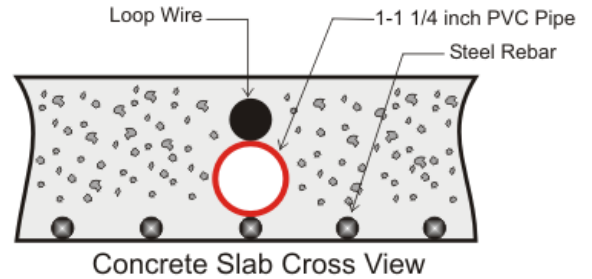

SAW CUT EXISTING SURFACE

Cut 1" deep into the existing surface, place a 45° cut at the corners to prevent sharp edges from damaging the loop wire. Notch out for the "T" connection where the lead wire connects to the loop. Remove all debris from the finished cut with compressed air. Place the loop into the saw cut. Place backer material into the saw cut over the loop wire and pack tightly. Place a high-quality sealer over the saw cut to seal the surface.

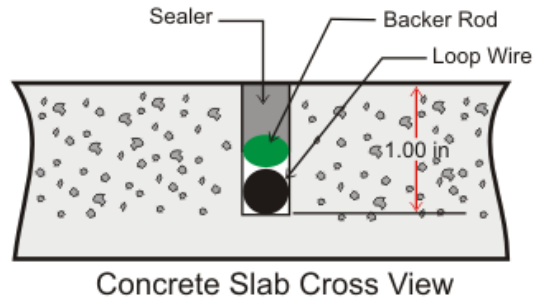

RESURFACE ASPHALT

Saw cut the existing surface 3/4" deep and place a 45° cut at the corners to prevent sharp edges from damaging the loop wire. Remove all debris from the finished cut with compressed air. Place sand over the loop wire to the surface and pack tightly. Lay new asphalt.

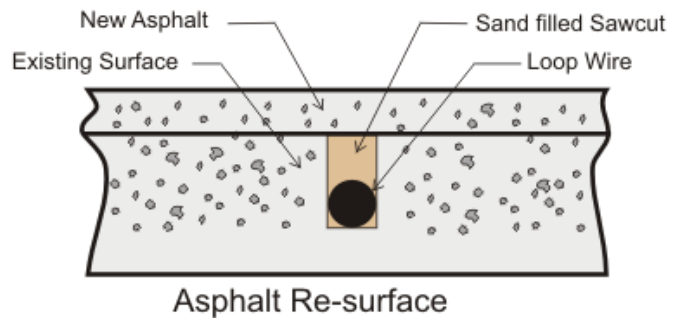

GRAVEL OR SOIL INSTALLATION

While this is not a recommended installation for most loops, it has been used successfully with proper preparation. Remove gravel or top soil until reaching a stable base. Dig ~ 6-8" deep by ~ 6-8" wide. Fill halfway with sand and pack tightly. Place the loop into the trench and finish filling to level with sand. Pack tightly and replace gravel or soil over top.

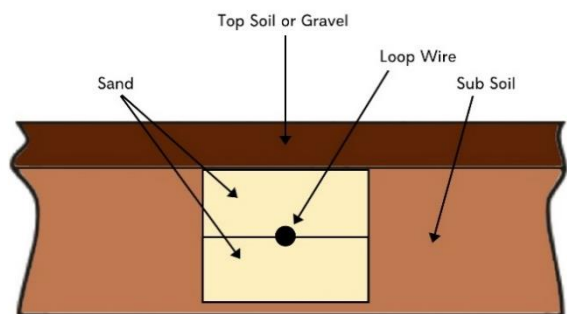

GENERAL INSTALLATION GUIDELINES

- Use EMX lite preformed loops for quick, reliable installations.
- It is not recommended to install a loop near power lines (overhead or underground) or low voltage lighting. If necessary near these power sources, place at a 45° angle. Make the loop shape a diamond, not a square.
- Never install a loop near inductive heaters.
- If using a non-preformed loop, lead-in wire (wire from loop to detector) must be twisted a minimum of 6 turns per foot to avoid the effects of noise or other interference.
- Detection height is approximately 70% of the shortest side of the loop.
For example: detection height for a 4' x 8' loop = 48" x .7 = 33.6"

Installation

1. Connect the 11 pin DIN rail socket or wire harness to the ULT-MVP-2 and connect the pins 1 and 2 (white and black wire) on the socket/harness to the appropriate power source. **Pin 4 (green wire) must be connected to earth ground for effective surge protection.**

2. Connect channel 1 loop wires to pins 7 and 8 (gray and brown wire) and channel 2 loop wires to pins 10 and 11 (pink and violet wire).

3. Connect the operator wires to the socket/harness according to preferences and instructions provided by the operator manufacturer (see [Wiring Connections](#)).

4. Configure the non-channel specific DIP switch settings. (DIP switch settings 4 through 8 are non-channel specific.)

TIP:

To check current channel specific configurations, press the CHANNEL SET-UP button. The current settings for the channel selected by DIP switch 1 will flash on the ULTRAMETER™ display according to the Channel Settings table. (See [Settings & Displays](#)).

5. Set DIP switch 1 to the channel being changed. DIP switches 2 and 3 correspond with channel specific settings.

6. Press the CHANNEL SET-UP button to enter channel set-up mode. The display will continuously rotate through the settings for the selected channel: Channel (C), Sensitivity (S), Loop Frequency (F), Pulse/Presence (Pu), and Detect-on-Stop™ (d).

TIP:

To exit channel set-up, re-press on the CHANNEL SET-UP button. If the decimal point light is not on, no channel settings will be changed by exiting.

7. Configure DIP switches 2 and 3 according to preferences for this channel. If a change is made, the decimal point light on the ULTRAMETER™ display will turn on.

TIP:

If a DIP switch is already in the preferred on/off position, move the DIP switch out of the preferred configuration and back, the decimal point light on the ULTRAMETER™ display will turn on.

8. Press the CHANNEL SET-UP button to store channel settings.

9. Repeat steps 2 through 8 for the second channel.

10. Adjust the sensitivity setting to desired level to assure detection of all vehicle traffic.

- To test the sensitivity of a channel's loop, move DIP switch 1 to that channel so that the display will show that loop's detection level. Drive a vehicle, without moving the sensing loops, near that channel's loop. When the vehicle is first detected by the loop, "9" will be displayed on the ULTRAMETER™ display. Position the vehicle over the loop where detection point is desired, take note of the number displayed on the ULTRAMETER™. Move the test vehicle away from the loop to remove it from the detection zone (ULTRAMETER™ display should be blank).
- Press the CHANNEL SET-UP button and change the sensitivity setting (10-position rotary switch) to match the number that was on the ULTRAMETER™ display at the point of desired detection.

11. Press the CHANNEL SET-UP button to configure new sensitivity and exit programming mode.

- Retest the product by moving the vehicle into and out of the detection zone to make sure the set-up and location are working as intended.

12. Repeat steps 10 and 11 for the second channel.

Troubleshooting

Symptom	Possible Cause	Solution
Channel 1 or 2 Red LED flashes	Loop wire shorted or open	<p>Refer to the indicators in the Settings and Display section to determine the channel of the LED to determine which loop is open/shorted.</p> <p>Check the loop resistance with a multimeter to confirm a reading between 0.5 ohms and 5 ohms. If reading is outside of this range, replace the loop. The reading should be steady.</p> <p>Check loop connections to terminals. Verify that splices are properly soldered and sealed against moisture.</p>
Channel 1 or 2 Red LED on constantly (stuck in detection mode)	<p>Faulty loop</p> <p>Poorly crimped connection or loose connection</p>	<p>Refer to the indicators in the Settings and Display section to determine the channel of the LED to determine which loop is open/shorted.</p> <p>Perform a megger test from loop lead to ground, it should be more than 100 mega ohms.</p> <p>Check loop connections to terminals. Verify that splices are properly soldered and sealed against moisture.</p> <p>Move DIP switch 1 to the channel corresponding to the red LED stuck in detection mode and observe the ULTRAMETER™ display. The level indicated on the display indicates residual frequency shift from vacant loop to vehicle presence. Press the CHANNEL SET-UP button to re-initialize the detector.</p>
Detector detects intermittently when no vehicle is on the loop	<p>Faulty loop</p> <p>Poorly crimped connection or loose connection</p> <p>Cross-talk between multiple loop detectors</p> <p>Loop not securely installed, prevent movement of loop in pavement.</p>	<p>Refer to the indicators in the Settings and Display section to determine the channel of the LED to determine which loop is open/shorted.</p> <p>Perform a megger test from loop lead to ground, it should be more than 100 mega ohms.</p> <p>Check loop connections to terminals. Verify that splices are properly soldered and sealed against moisture.</p> <p>Set multiple loops to different frequencies.</p> <p>Verify that loop is securely installed in pavement and that site is in good condition to prevent movement of loop wires.</p>

Symptom	Possible Cause	Solution
One stationary segment showing on ULTRAMETER™ display	Loop frequency fault	<p>Refer to the Loop Fault Indicators table in the Settings and Display section to determine which loop's frequency is causing the symptom and if the frequency is too high or too low.</p> <p>If the frequency is too high, lower the frequency set by DIP switch 7 and 8. If the frequency is too low, raise the frequency set by DIP switch 7 and 8.</p> <p>Press the CHANNEL SET-UP button to re-initialize detector.</p> <p>Replace the faulty loop if raising/lowering the frequency setting does not solve the problem.</p>
No detection	<p>Loop wire shorted or open</p> <p>Loop sensitivity set too low</p>	<p>Check the loop resistance with a multimeter to confirm a reading between 0.5 ohms and 5 ohms. If reading is outside of this range, replace the loop. The reading should be steady.</p> <p>With a vehicle on the loop, move DIP switch 1 to the channel corresponding to the malfunctioning loop and observe the ULTRAMETER™ display. Set sensitivity level to the level indicated on the display.</p>

Warranty

EMX Industries, Inc. products have a warranty against defects in materials and workmanship for a period of two years from date of sale to our customer.