

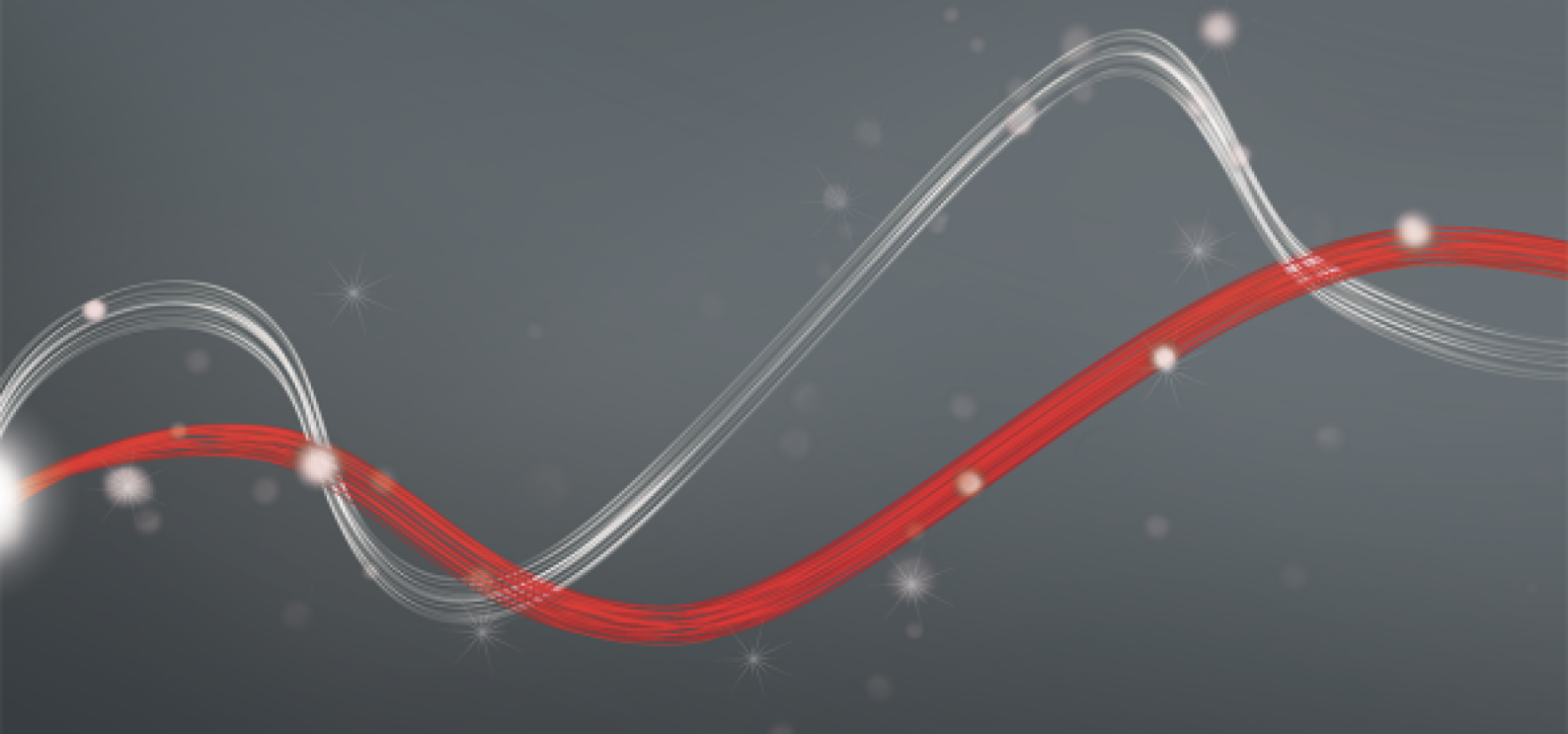

Be ahead



MAXIMA ULTRA 36





MAXIMA ULTRA 36



Automatic barriers - road barriers



U-Link



rolling code



Silentech



inverter



Oil Gear



Block



Encoder

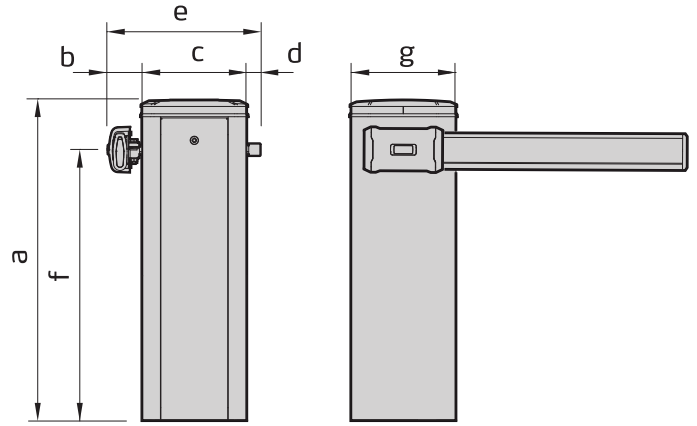
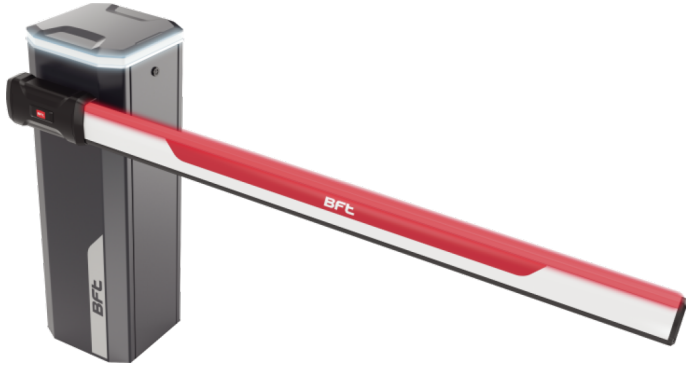

a	b	c	d	e	f	g
1030	110	338	45	493	870	338

Range of professional electromechanical barriers with inverter and asynchronous three-phase motor for frequent use. Suitable for controlling gates between 2 and 6 metres in width, with fully accessorised bar in a single model. Cap with RGB lights (optional) to serve as traffic light, indicate availability of parking places and for self-diagnosis.





Automatic barriers - road barriers

MAXIMA ULTRA 36

Code	Name	Description
P940093 00002	MAXIMA ULTRA 36 230V	RAL 7015 barrier, including standard spring, 230V. Cap excluded
P940093 00202	MAXIMA ULTRA 36 INOX 230V	Stainless steel barrier, including standard spring, 230V. Cap excluded
P940093 00102	MAXIMA ULTRA 36 230V RAL	RAL custom barrier, including standard spring, 230V. Cap excluded
P940094 00002	MAXIMA ULTRA 36 XL 230V	RAL 7015 barrier, including strong spring, 230V. Cap excluded
P940094 00202	MAXIMA ULTRA 36 XL INOX 230V	Stainless steel barrier, including strong spring, 230V. Cap excluded
P940094 00102	MAXIMA ULTRA 36 XL RAL 230V	RAL custom barrier, including strong spring, 230V. Cap excluded
P940093 00001	MAXIMA ULTRA 36 120V	RAL 7015 barrier body, includes standard spring, 120 V. Excludes cap
P940093 00201	MAXIMA ULTRA 36 120V INOX	Stainless steel barrier body, includes standard spring, 120 V. Excludes cap
P940093 00101	MAXIMA ULTRA 36 120V RAL	Custom RAL barrier body, includes standard spring, 120 V. Excludes cap
P940094 00001	MAXIMA ULTRA 36 XL 120V	RAL 7015 barrier body, includes strong spring, 120 V. Excludes cap
P940094 00201	MAXIMA ULTRA 36 XL INOX 120V	Stainless steel barrier body, includes strong spring, 120 V. Excludes cap
P940094 00101	MAXIMA ULTRA 36 XL RAL 120V	Custom RAL barrier body, includes strong spring, 120 V. Excludes cap

CSB XT: 24V single operator control unit for barriers

CSB XT - Built in



- Card power supply: 230 V single-phase
- Main characteristics: removable terminal boards with the new colour standard, simplified programming with scenario display, integrated two-channel receiver, D-Track based antisquashing system and slowdown during opening or closing.
- 24V single operator control unit for barriers

	MAXIMA ULTRA 36 230V	MAXIMA ULTRA 36 INOX 230V	MAXIMA ULTRA 36 230V RAL	MAXIMA ULTRA 36 XL 230V	MAXIMA ULTRA 36 XL INOX 230V	MAXIMA ULTRA 36 XL RAL 230V
Opening or closing time	from 0.7 to 3.9 s	from 0.7 to 3.9 s	from 0.7 to 3.9 s	from 0.7 to 3.9 s	from 0.7 to 3.9 s	from 0.7 to 3.9 s
Control unit	CSB-XT	CSB-XT	CSB-XT	CSB-XT	CSB-XT	CSB-XT
Frequency of use	Continuous	Continuous	Continuous	Continuous	Continuous	Continuous
Clear opening	from 2 to 6 m	from 2 to 6 m	from 2 to 6 m	from 2 to 6 m	from 2 to 6 m	from 2 to 6 m
Motor type	Three-phase asynchronous	Three-phase asynchronous	Three-phase asynchronous	Three-phase asynchronous	Three-phase asynchronous	Three-phase asynchronous
Gear unit type	In oil bath	In oil bath	In oil bath	In oil bath	In oil bath	In oil bath
Inverter	Yes	Yes	Yes	Yes	Yes	Yes
Slowdown	Yes	Yes	Yes	Yes	Yes	Yes
Impact reaction	Encoder	Encoder	Encoder	Encoder	Encoder	Encoder
Locking	Mechanical	Mechanical	Mechanical	Mechanical	Mechanical	Mechanical
Release	Inside the structure	Inside the structure	Inside the structure	Inside the structure	Inside the structure	Inside the structure
MCBF (Mean Cycles Between Failures)	7000000 Op	7000000 Op	7000000 Op	7000000 Op	7000000 Op	7000000 Op
Environmental conditions	-40 ÷ 60 °C	-40 ÷ 60 °C	-40 ÷ 60 °C	-40 ÷ 60 °C	-40 ÷ 60 °C	-40 ÷ 60 °C
Protection rating	IP55	IP55	IP55	IP55	IP55	IP55







	MAXIMA ULTRA 36 120V	MAXIMA ULTRA 36 120V INOX	MAXIMA ULTRA 36 120V RAL	MAXIMA ULTRA 36 XL 120V	MAXIMA ULTRA 36 XL INOX 120V	MAXIMA ULTRA 36 XL RAL 120V
Opening or closing time	from 0.7 to 3.9 s	from 0.7 to 3.9 s	from 0.7 to 3.9 s	from 0.7 to 3.9 s	from 0.7 to 3.9 s	from 0.7 to 3.9 s
Control unit	CSB-XT	CSB-XT	CSB-XT	CSB-XT	CSB-XT	CSB-XT
Frequency of use	Continuous	Continuous	Continuous	Continuous	Continuous	Continuous
Clear opening	from 2 to 6 m	from 2 to 6 m	from 2 to 6 m	from 2 to 6 m	from 2 to 6 m	from 2 to 6 m

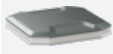
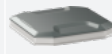
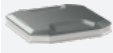
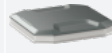
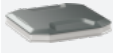
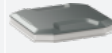

Automatic barriers - road barriers

	MAXIMA ULTRA 36 120V	MAXIMA ULTRA 36 120V INOX	MAXIMA ULTRA 36 120V RAL	MAXIMA ULTRA 36 XL 120V	MAXIMA ULTRA 36 XL INOX 120V	MAXIMA ULTRA 36 XL RAL 120V
Motor type	Three-phase asynchronous	Three-phase asynchronous	Three-phase asynchronous	Three-phase asynchronous	Three-phase asynchronous	Three-phase asynchronous
Gear unit type	In oil bath	In oil bath	In oil bath	In oil bath	In oil bath	In oil bath
Inverter	Yes	Yes	Yes	Yes	Yes	Yes
Slowdown	Yes	Yes	Yes	Yes	Yes	Yes
Impact reaction	Encoder	Encoder	Encoder	Encoder	Encoder	Encoder
Locking	Mechanical	Mechanical	Mechanical	Mechanical	Mechanical	Mechanical
Release	Inside the structure	Inside the structure	Inside the structure	Inside the structure	Inside the structure	Inside the structure
MCBF (Mean Cycles Between Failures)	7000000 Op	7000000 Op	7000000 Op	7000000 Op	7000000 Op	7000000 Op
Environmental conditions	-40 ÷ 60 °C	-40 ÷ 60 °C	-40 ÷ 60 °C	-40 ÷ 60 °C	-40 ÷ 60 °C	-40 ÷ 60 °C
Protection rating	IP55	IP55	IP55	IP55	IP55	IP55

RECOMMENDED ACCESSORIES

	P940095 00000 - Crown MAXIMA U36 Cap without lights for Maxima Ultra 36.		P940095 00003 - Crown RGB MAXIMA U36 Cap with RGB lights for Maxima Ultra 36. Functions: flashing, traffic light, diagnostics.
	P940095 00200 - Crown MAXIMA U36 INOX Cap without lights for Maxima Ultra 36 INOX.		P940095 00203 - Crown RGB MAXIMA U36 INOX Cap with RGB lights for Maxima Ultra 36 Stainless Steel. Functions: flashing, traffic light, diagnostics.
	P940095 00100 - Crown MAXIMA U36 RAL Cap without lights for Maxima Ultra 36. Custom RAL		P940095 00103 - Crown RGB MAXIMA U36 RAL Cap with RGB lights for Maxima Ultra 36. Custom RAL. Functions: flashing, traffic light, diagnostics.
	P120088 - DIMA PRO36 Foundation template and clamps for installation of Maxima Ultra 36 barriers.		P120087 00001 - BOOM PS30 Aluminium bar, opening L = 3 m with red reflectors. Includes rubber and upper optical diffuser. Lights excluded.
	P120087 00002 - BOOM PS40 Aluminium bar, opening L = 4 m with red reflectors. Includes rubber and upper optical diffuser. Lights excluded.		P120087 00003 - BOOM PS50 Aluminium bar, opening L = 5 m with red reflectors. Includes rubber and upper optical diffuser. Lights excluded.
	P120087 00004 - BOOM PS60 Aluminium bar, opening L = 6 m with red reflectors. Includes rubber and upper optical diffuser. Lights excluded.		P120084 00000 - OMEGA PS MAXIMA U36 Single lock for protective finger trapping casing and screws for MAXIMA ULTRA 36. BOOM PS bar excluded.

















MAXIMA ULTRA 36

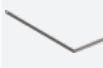

Automatic barriers - road barriers

RECOMMENDED ACCESSORIES

	new P120094 00000 - OMEGA FRA PS MAXIMA U36 Resettable impact protection connector (manual) for Maxima Ultra 36 barrier. BOOM PS bar excluded.		new P120089 10001 - LIGHT PS 30-B High intensity LED lighting kit, red-green, to be fitted on BOOM PS bar up to 3 metres long. Power supply unit excluded.
	new P120089 10002 - LIGHT PS 40-B High intensity LED lighting kit, red-green, to be fitted on BOOM PS bar up to 4 metres long. Power supply unit excluded.		new P120089 10003 - LIGHT PS 50-B High intensity LED lighting kit, red-green, to be fitted on BOOM PS bar up to 5 metres long. Power supply unit excluded.
	new P120089 10004 - LIGHT PS 60-B High intensity LED lighting kit, red-green, to be fitted on BOOM PS bar up to 6 metres long. Power supply unit excluded.		P120075 - ALLU 2 MAXIMA ULTRA Power supply for ATM LIGHT Kit on Maxima Ultra
	P120091 - HYPHEN PS Internal reinforcement/joint for BOOM PS booms. Already included in the Maxima Ultra 36 XL barriers but recommended for barriers L >= 5 m with or without accessories.		P120085 - BTM-SKIRT Lower skirt for BOOM PS booms. Module length L = 2 m.
	P120086 - FULL-SKIRT Full skirt (top and bottom) for BOOM PS booms. Module length L = 2 m. Does not include SKIRT BRACKET required for anchoring the first module to the barrier body.		P120095 - BRACKET SKIRT Connection bracket between barrier body and simple (BTM SKIRT) or double (FULL SKIRT) aluminium rack.
	P120093 - ADJ-FOOT Suspended cushioned telescopic supporting foot for BOOM PS booms.		P120092 - KIT ART90 PS Kit for 90° articulated bar. Excludes bar, bar connector, LIGHT PS lighting. Compatible with BOOM PS booms.
	P120092 00001 - ART90 BOOM PS30 Boom bar PS 90° articulated L = 5 m pre-fitted. Excludes LIGHT PS lighting.		P120092 00002 - ART90 BOOM PS30 R/G Boom bar PS L = 5 m 90° articulated including bar and LIGHT PS lighting pre-fitted.
	P120092 00003 - ART90 BOOM PS50 Boom bar PS 90° articulated L = 5 m pre-fitted. Excludes LIGHT PS lighting.		P120092 00004 - ART90 BOOM PS50 R/G Boom bar PS L = 5 m 90° articulated including bar and LIGHT PS lighting pre-fitted.
	P120080 - FAF UNI R Universal adjustable fork for all rods; recommended with installation of FULL SKIRT accessory.		P120079 - EBB KIT ATML Electric lock for ATML rods to be installed on an FAF UNI R adjustable fork.





Automatic barriers - road barriers

What is U-Link?

The technology that gives you more power

U-Link, Universal Link, is an exclusive BFT platform that can be used to create high-tech ecosystems. In Home Access Automation, it can be used to communicate with all home access automation devices of any brand. This saves you time and allows you to control everything easily and without any worries.

It is intuitive

Easy to install and to use

It is scalable

You can add as many devices as you want

It is flexible

It allows you to create groups of interconnected products

It is practical

Works with or without an internet connection

It is functional

Its settings can be controlled remotely using dedicated applications



Automatic barriers - road barriers

Everything on one screen: find out more about this amazing technology

A world-exclusive platform that **can be used to create high-tech ecosystems** offering a vast range of solutions for many different sectors.

This proprietary platform which is a key feature of BFT products, thanks to the B-EBA cards and the Clonix U-Link receiver, is suitable for any protocol or product for access automation (including BFT products non-BFT ones and older versions) and it can be used in a variety of different sectors. This means any device becomes a smart device which can be interconnected with other systems, using a language that is becoming universal.



U-Control HOME

U-Control HOME is the application that allows you to open the gate to your home and to remotely control BFT automations using your own smartphone. The iOS version can be used to automatically open the automation when you are close to it.



U-Base 2

A software package for installation, performing maintenance and identifying any faults in the U-Link compatible operators, easily and conveniently.



U-SDK

U-SDK is the application which allows BFT automations to be made compatible and easily integrated with a BMS network.



Clonix U-Link

Connect non-native U-Link and non-BFT products to U-Link systems.

Is it possible to connect non-native U-Link BFT operators or other brands of products to U-Link? Yes, thanks to the Clonix receivers. Accessories which accept no limits.



B-EBA

A direct link to your operators.

The B-EBA expansion cards make it possible to connect external devices such as PCs, smartphones and tablets to a BFT operator and a Clonix receiver or to connect multiple BFT products in a U-Link network. These accessories integrate with U-Link technology and with Bluetooth, Wifi, Z-Wave and TCP/IP protocols as well as with the RS485 serial interface. A device that demonstrates exactly what BFT means by interconnectivity.

